

OVER 240,000 COPIES OF THIS ISSUE PRINTED AND DISTRIBUTED

RADIO NEWS

REG. U. S. PAT. OFF.

25 Cents
December

1923

Over 200 Illustrations

Edited by H. GERNSBACK

"LOCAL INTERFERENCE"



THE 100% WIRELESS MAGAZINE

CIRCULATION LARGER THAN ANY OTHER RADIO PUBLICATION

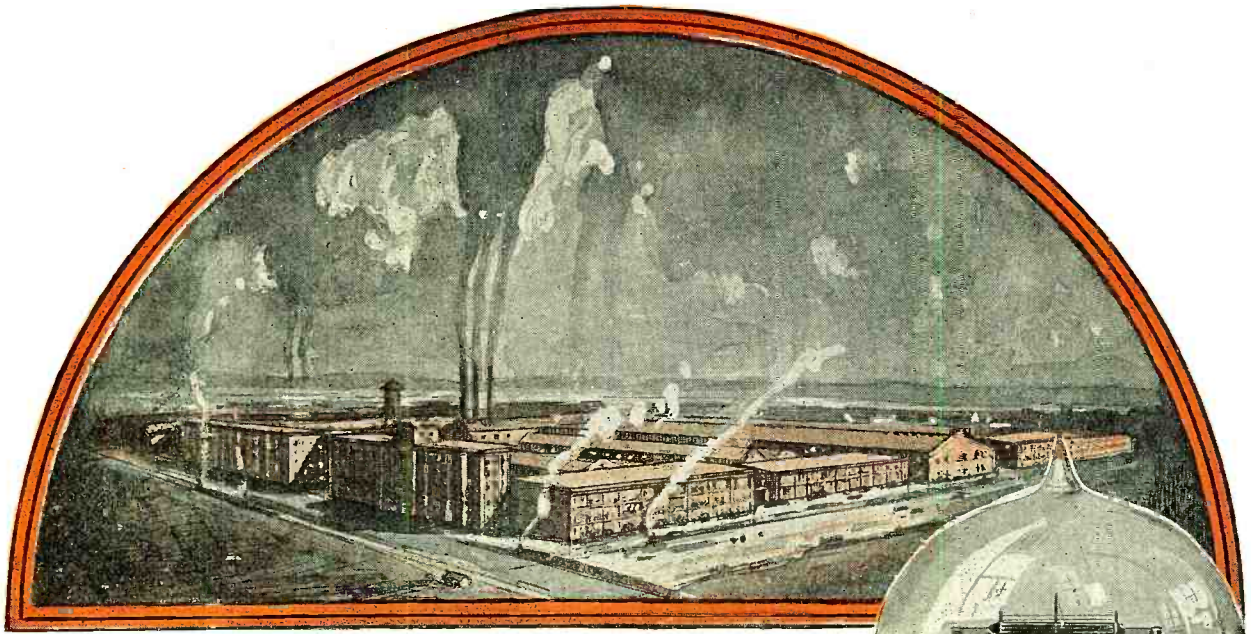

Cunningham tubes

A MONUMENT TO SCIENTIFIC RESEARCH

CUNNINGHAM VACUUM TUBES, built by one of the world's largest manufacturers with unlimited resources, are the product of years of research and development work by that great scientific organization, the Research Laboratory of the General Electric Company.

The development of the special filament used in the two new *Cunningham Tubes*, type C-301-A and C-299, is truly a monument to the scientific skill of that organization and the ability of its engineers.

The outstanding feature of this filament is its property of high electron emission at a low temperature. This results in a Vacuum Tube having a greatly increased output, with only a fraction of the filament power consumed by previous types.



$\frac{1}{4}$ Ampere Filament
Current.
Mutual Conductance
700 Micromhos.

Cunningham Radio Tubes	
C-301A—6 Volts $\frac{1}{4}$ amp. Amplifier.....	\$6.50
C-299—3 Volts .06 amp. Dry Battery Det. & Amp.....	6.50
C-300—6 Volts Gas Con- tent Detector.....	5.00
C-11—1.1 Volts .25 amp. Dry Battery Det. and Amp. Special Base.....	6.50
C-12—Similar to C-11 with standard base.....	6.50

Patent Notice: *Cunningham tubes are covered by patents dated 11-7-05, 1-15-07, 2-18-08, and others issued and pending. Licensed for amateur, experimental and entertainment use in radio communication. Any other use will be an infringement.*

E. J. Cunningham Inc.



154 West Lake Street
Chicago, Illinois

Home Office:
182 Second St.
San Francisco, Calif.

30 Church Street
New York City, N. Y.

ONE OF THE
GERACO
PROVED RADIO PRODUCTS



The Same Soft Liquid Tones!

The unusual appeal of the voices of the boy choir is carefully carried to you by MUSIC MASTER.

In this wonderful Radio Reproducer, you hear the same clear, beautiful notes that you would if you were hearing the choir *itself*.

The *wood* horn of MUSIC MASTER accounts for much of its success. *Wood* is the only material that can bring out the rich resonance of voices or musical instruments.

Hear MUSIC MASTER, radio's marvelous *musical instrument*. Ask your radio dealer to attach it to a good set and let it *talk for itself!*

Dealers Everywhere

14" Model for the Home
(Light or dark-finish horn) \$30
21" Model for Concerts
(Dark-finish horn only) . . . \$35

GENERAL RADIO CORPORATION

Makers and Distributors of High-Grade Radio Apparatus

S.W. Cor. 10th and Cherry Sts.

Chicago

Philadelphia

Pittsburgh

Music Master

RADIO REPRODUCER

RADIO NEWS

Published by EXPERIMENTER PUBLISHING COMPANY, INC.
 Publishers of "Radio News," "Science and Invention" and "Practical Electrics."
 Publication Office: Jamaica, N. Y. Editorial and General Offices: 53 Park Place, N. Y. City
 H. GERNSBACK, President S. GERNSBACK, Treasurer R. W. DEMOTT, Secretary

VOL. 5 CONTENTS FOR DECEMBER NO. 6

	Page		Page
Editorial By H. Gernsback	679	C.W. and Radiophone Transmitters—Part III, By L. R. Felder	705
Multiple Broadcasting By S. R. Winters	680	The Dope on the Second National A.R.R.L. Convention By L. W. Hatry	706
Radio Vision By H. Gernsback	681	Canadian Station 9BP Reaches Arctic, By Jack Barnsley	707
The Radio Chauffeur Call, By Dr. Lee De Forest	682	Duplex Reception By R. E. Sabin	708
The Clariphone, a New Static Eliminator, By S. R. Winters	683	Simplifying Amplifier Construction, By F. M. Holbrook	709
The Radio Controlled Aeroplane, By Maurice Percheron	684	A Regenerative Loop Receiver, By Edwin K. Borchard	710
A New and Ultra-Sensitive Detector, the Sodian, By John V. L. Hogan	686	Notes on the Autoplex Circuit, By M. L. Muhleman	711
A New High Power Tube By Laurence S. Lees	688	Observations at the Receiving End of the Radiophone By W. A. Knight	712
Awards of the Reflex Prize Contest	689	Crystal Detectors and Their Possibilities as Am- plifiers and Oscillators. By John W. Million, Jr.	714
Construction of Super-Heterodyne Receivers, By F. de Willy and R. E. Lacault	690	Outline of the Problem of Radio Control, By Olle D. Engstrom	716
Simplifying the Radio Receiving Set, By James Ashton Greig	692	The Pritchard Universometer By P. A. Price	719
Audio Frequency Amplification By Louis Frank	693	Awards of the \$50 Radio Wrinkle Contest	720
A Complete Radio Library at Amateur Price, By S. R. Winters	694	Radio News Laboratories	722
Fertile Florida By Armstrong Perry	695	Radio Trade News By L. A. Nixon	723
Soland's Radio Tomb By Ellis Parker Butler	696	I-Want-To-Know	724
Radio Oddities	697	New Radio Patents	726
Commercial Possibilities of Wired Radio for Central Stations By Bert T. Bonaventure	698	Correspondence From Readers	727
With the Amateurs	700	Complete List of Broadcasting Stations—Cor- rected to September 25th	728
The Transmitter at Station 8AZ By J. E. Fetzer	702	Radio Poems	789
An Efficient Amateur Station, By Baldwin G. Sullivan	703	Book Review	814
Fixin' Up the Shack By Howard S. Pyle	704		
Index to Advertisers	668		

General Advertising Dept., 53 Park Place, New York City. Western Advertising Representatives, Finucan & McClure, 720 Cass Street, Chicago, Ill. Kansas City Representative, Geo. F. Dillon, Republic Bldg., Kansas City Mo. Pacific Coast Advertising Representatives, A. S. Norris Hill Co., Hearst Bldg., San Francisco, Cal.

RADIO NEWS is published on the 10th of each preceding month. There are 12 numbers per year. Subscription price is \$2.50 a year in U. S. and possessions. Canada and foreign countries, \$3.00 a year. U. S. coin as well as U. S. Stamps accepted (no foreign coins or stamps). Single copies, 25 cents each. A sample copy will be sent gratis on request. Checks and money orders should be drawn to order of EXPERIMENTER PUBLISHING CO., INC.

All communications and contributions to this journal should be addressed to Editor, RADIO NEWS, 53 Park Place, New York, N. Y. Unaccepted contributions cannot be returned unless full postage has been included. All accepted contributions are paid for on publication. A special rate is paid for novel experiments; good photographs accompanying them are highly desirable.

RADIO NEWS, Monthly. Entered as second-class matter at the Post Office, at Jamaica, N. Y., under the act of March 3, 1897. Title registered U. S. Patent Office. Copyright, 1923, by E. P. Co., Inc., New York. The Experimenter Publishing Co., 53 Park Place, N. Y. The Contents of this magazine are copyrighted and must not be reproduced without giving full credit to the publication.

RADIO NEWS is for sale at all newsstands in the United States and Canada; also at The International News Co., Ltd., Bream's Building, London E. C. 4, England and at Brentano's 37 Avenue de l'Opera, Paris.

HOW TO SUBSCRIBE FOR RADIO NEWS. Send your name, address and remittance to Experimenter Publishing Co., 53 Park Place, New York. Mention the name of the magazine you are ordering. We also publish SCIENCE AND INVENTION and PRACTICAL ELECTRICS. Write early.

RATES AND TERMS. The subscription rate for RADIO NEWS is \$2.50 per year. (12 numbers). When remitting do so by check, money order, or registered letter if cash is enclosed. Avoid sending cash through the mail if possible. Subscriptions for less than one year are not accepted. Subscription may be made in combination with SCIENCE AND INVENTION or PRACTICAL ELECTRICS with considerable saving.

POSTAGE. We prepay postage in all parts of the United States, Mexico and island possessions. For foreign or Canadian subscriptions we require 50 cents in addition to the subscription price for additional postage charges.

CHANGE OF ADDRESS. Notify us as far in advance as possible. It requires several weeks to make an address change on our records. Always write clearly, giving your old address as well as your new.

ON EXPIRATION of your subscription we enclose a renewal blank in our last number to you; we stop our delivery to you on expiration.

COMMUNICATIONS to us should always bear your full name, address and when possible the number which appears on your wrapper every month.



"For the ear to desire pleasant sounds is natural." Mencius

There are no sounds more pleasant than the music brought by the

GREBE

Broadcast Receiver - *Doctor Mu.*

REGENERATION and Tuned Radio Frequency Amplification find their first successful combination in this Receiver. The 20-foot silk-covered wire, readily concealed behind the picture moulding is the only antenna required.

The attractively finished walnut cabinet has compartments for all necessary batteries.

Write for "GREBE Radio in the Well-Appointed Home"

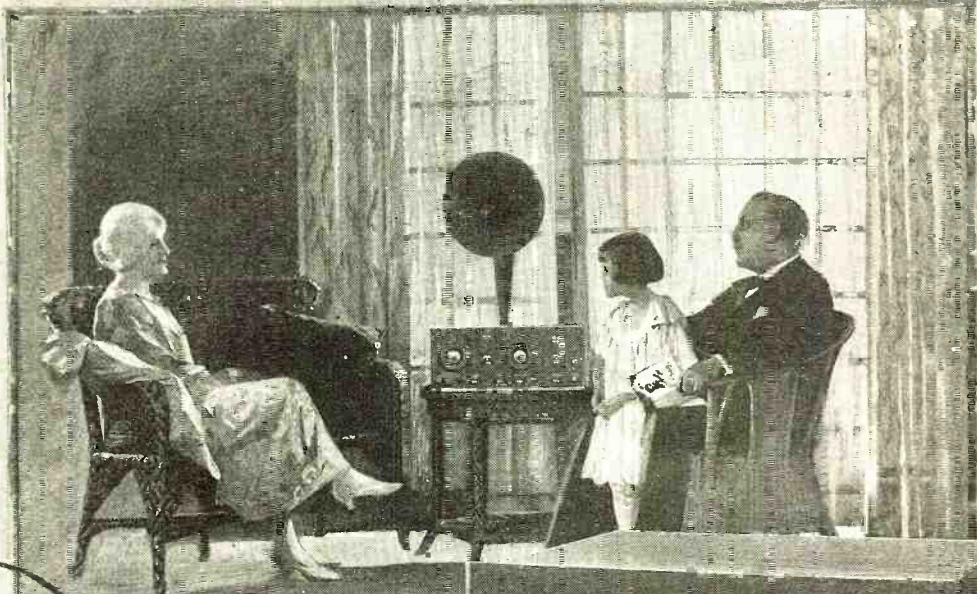

GREBE RADIO



A. H. GREBE & COMPANY, Inc.
Richmond Hill, N.Y.
Western Branch, 451 East 3rd St., Los Angeles, Ca.

Licensed under Armstrong
U. S. Pat. No. 1,113,149

Type CR-12

Index to Advertisers

A	Page
Acme Apparatus Company ..	751
Aitken Radio Company	780
Alden Mfg. Company	778
Allen-Bradley Company	952
<i>Inside Back Cover</i>	
Alter, Harry, & Company ..	820
American Electrical Heater Company	748
American Hard Rubber Com- pany	805
American Specialty Company, The	813
American Transformer Com- pany	784
Anchor Company, The	766
Andrae & Sons Company, Julius	734
Andrea, Inc., F. A. D.	747
Atwater Kent Mfg. Company	757
Automatic Electrical Devices Co., The	833
Autoyre Co., The	798
Ayres Battery Corporation ..	818
B	
Bakelite Corporation	829
Baldwin, Inc., Nathaniel ..	813
Barawik Company, The	674
Bates & Company	831
Beckley Ralston Company ..	829
Benham, E. W.	822
Bergen Radio Supply Com- pany	840
Bogue, B. N.	841
Boice, W. B. & J. E.	841
Box 233	742
Brach Mfg. Company, L. S. ..	816
Brandes, Inc., C.	821
Branston, Inc., Chas. A.	846
Bremmer-Tully Mfg. Com- pany	846
Bristol Company, The	774
Brockway Laboratories Com- pany	778
Brown Company, Thomas ..	830
Brownlie, Roland	828
C	
Cardwell Mfg. Corp., Allen D. ..	755
Carter Radio Company	784
Central Radio Laboratories ..	845
Chaslyn Company, The	828
Chemical Institute of New York, Inc.	803
Chicago Salvage Stock Store	799
Chicago Solder Company ..	768
Clapp-Eastham Company ..	756
Clearstone Radio Company, The	765
Columbia Radio Corporation	822
Como Apparatus Company ..	825
Connecticut Tel. & Electric Company	822
Cousrad Company, Inc., The	764, 772, 804, 848
Continental Fibre Company, The	830
Continental Radio & Electric Corp.	782
Cook Electric Company	830
Co-operative Sales Company	840
Copper Clad Steel Company	818
Coto-Coil Company	811
Coyne School of Drafting ..	824
Crosley Mfg. Company	673
Cunningham, Inc., E. T.	
<i>Inside Front Cover</i>	
Cutler-Hammer Mfg. Com- pany, The	678, 739
Cut Rate Radio Company ..	831
D	
Dalton, Wittier, True Com- pany	851
Daniel, R. W.	818
Daven Radio Company	758
Dayton Fan & Motor Com- pany	775
Delta Electric Company	737
Diamond State Fibre Company	753
Dictograph Products Corpora- tion	745
Dobbins, Ray	817
Dodge's Institute	834
Dodge Radio Short Cut	798
Dubilier Condenser & Radio Corporation	791
Duck Company, The Wm. B. ..	817
Durkee-Thomas Products Company	836

E	Page
Eagle Radio Company	835
Electrical Research Labora- tories	772, 790, 804
Electric Service Supplies Company	822
Electric Specialty Company	800
Electric Storage Battery Company, The	743
Electro Importing Co.	801
Engravers & Printers Machin- ery Co.	796
Erisman Laboratories, The ..	820
Evans & Company, Victor J. ..	814
Experimenters Information Service	763
F	
Fahnestock Electric Company	837
Fansteel Products Company, Inc.	823
Federal Telephone & Tele- graph Company	812
Ferbend Electric Company ..	732
Fischer & Company, G. H.	834
Ford Mica Company, Inc.	810
Forman & Company	834
Formica Insulation Co., The	749
France Mfg. Company, The	824
Freshman Company, Inc., Chas.	769
Frost, Inc., Herbert H.	671
Furness Bermuda Line	846
G	
General Electric Company ..	742
General Radio Company	740
General Radio Corporation ..	665
Gilfillan Bros., Inc.	761
Globe Electric Company	738
Goodell-Pratt Company	754
Goodman, L. W.	824
Gould Storage Battery Com- pany	782
Great Lakes Radio Company	735
Grebe & Company, Inc., A. H. ..	667
H	
H. & H. Radio Company	832
Hanes-Zener Company	827
Harvard Radio Laboratories ..	823
Hayden Radio & Research Co., A. C.	730
Hearst's International Maga- zine	758
Heath Radio & Electric Mfg. Company	826
Holtzer-Cabot Electric Com- pany, The	750, 812
Home Supply Company	834
Hommel & Company, Ludwig	826
Hudson-Ross	842
Hygrade Electrical Novelty Company	830
I	
Illinois Radio Company	830
International Correspondence Schools	828
International Tire Corporation	846
J	
Jones, Howard B.	831
K	
K Electric Company	746
Kellogg Switchboard & Sup- ply Company	783
Kennedy Company, The Colin B.	729
Kensington Radio Supply Company	816
Kilbourne & Clark Mfg. Com- pany	816
Killoch Company, David	817
Kimley Electric Company, Inc.	828
Klaus Radio & Electric Com- pany	820
Kloesner Improved Apparatus Co.	834
Knoop & Pence Company ..	840
L	
Lambert, Leon	778
Lancaster & Allwine	734
Leich Electric Company	827
Mc	
McLaughlin, J. E.	802
McKenzie Engineering Com- pany	736

M	Page
M & M Company, The	770
M. P. M. Sales Company	776
Magnavox Company, The	777
Marko Storage Battery Com- pany	792
Marshall-Gerken Company, The	808
Martin-Copeland Company ..	781
Marvel Radio Specialty Com- pany	828
Marvel-Switch Company	734
Massachusetts Radio & Tele- graph School	802
Michigan Radio Corporation ..	840
Midwest Radio Company, The	819
Mitchell & Company, R.	782
Modell's	797
Modern Electric Mfg. Com- pany, The	824
Montgomery Ward & Com- pany	767
Montrose Mfg. Co.	778
Morrison Laboratories, Inc. ..	818
Moss-Schury Mfg. Company, Inc.	754
Multiple Electric Products Co.	839
Mu-Rad Laboratories, Inc.	802
Murdock Company, Wm. J. ...	730
N	
Nassau Radio Company	832
National Airphone Corpora- tion	676, 677
National Carbon Company, Inc.	733, 773
National Chelsea Radio Cor- poration	746
National Radio Institute	669
National State & Local Tubercu- losis Association of the United States, The	814
Nazeley Company, J.	806
Newman-Stern Company, The	730
New York Coil Company	843
N. Y. Institute of Photog- raphy	800
Novo Mfg. Company	776
O	
Omnigraph Mfg. Company, The	810
O'Neil Mfg. Company	789
Owen, Richard B.	851
Ozment, C. J.	841
P	
Pacent Electric Company ..	764
Parker, C. L.	814
Pathé Phonograph & Radio Corporation	825
Personal Service Purchasing Bureau	840
Pignolet Instrument Co.	809
Pioneer Radio Corporation ..	744
Porell Company, Inc., George H.	836
Precision Equipment Com- pany, The	672
Press Company, The	734
Press Guild, Inc., The	798
Pudlin Engineering Company, Inc.	808
Q	
Q. T. Light Company, The ..	820
R	
Radiall Company	780
Radio Bargains	824
Radioceive Mfg. Co.	836
Radio Corporation of America Back Cover	
Radio Equipment Company ..	836
Radiogem Corporation	752
Radio Guild, Inc., The	845
Radio Improvement Co., Inc. ..	795
Radio Industries Corp.	786, 787
Radio Institute of America ..	738
Radio & Mechanical Trading Corp.	842
Radio Mfg. Company, The ..	816
Radio Products Mfg. Com- pany	794
Radio Rabat, The	812
Radio Research Guild	842
Radio Research Laboratories ..	732
Radio Specialty Co.	741
Radio Stores Corporation ..	771
Radio Tube Exchange	843
Radio Tube Repairing Com- pany	826
Radio Units, Inc.	736

R	Page
Randel Wireless Co.	808, 832
Randolph & Company	814
Rasta Sales Corporation	820
Rauland Mfg. Company	760
Reliable Parts Mfg. Company, The	846
Remler Radio Mfg. Company	766
Rhamstine, J. Thos.	792
Richter, Conrad	834
Riggs Mfg. Company, The ..	818
Rogers Radio Company	814
Rosendal & Company	815
Rose Radio Supply	796
Royal Mfg. Company	732
Rusonite Products Corporation	829
S	
Sadler Mfg. Company	815
Samson Electric Company ..	809
Saturn Mfg. & Sales Co., The	842
Schindler, Chas.	820
Scientific Electric Works, The	806
Sears, Roebuck & Company ..	770
Sectron Radio Company, The	841
Service Battery Company ..	742
Service Radio Company	806
Shinn Mfg. Company, W. C. ..	819
Shipman-Ward Mfg. Company	851
Sidbenel Radio Equipment Mfg. Company	802
Signal Electric Mfg. Company	731
Skinner, W. E.	784
Southern Toy Company, The ..	814
Springfield Wire & Tinsel Company	810
Star Mfg. Company	800
Steinmetz Wireless Mfg. Com- pany	754
Stramcy Products	826
Stromberg-Carlson Telephone Mfg. Co.	736
Superior Instrument Company	824
Sypher Mfg. Company	816
T	
Telephone Maintenance Com- pany	796
Tresco	843
Trimm Radio Mfg. Company	794
Trinity Radio Corporation ..	800
Tri State Radio Sales Co.	734
Tuska Company, The C. D. ...	759
Twitchell, S. A.	836
U	
U. S. Mfg. & Dist. Company	832
U. S. Tool Company, Inc. ..	780
Union Construction Company	792
Union Radio Corporation	732
United Mfg. & Distributing Company	807
United Radio Corporation ..	792
United Sales Company	826
Universal Chiropractors' Ass'n.	847
Unity Mfg. Co.	838
V	
V-De-Co Radio Mfg. Company	842
Valley Electric Company	738
Van Laboratories	782
Veritas, M.	851
Vesco Radio Shop	776
W	
Waits, E. F.	816
Walbert Mfg. Co.	780
Walker Company, Inc., G. E. ..	822
Walwart Electric Mfg. Com- pany	762
Westinghouse Union Battery Company	758
Weston Electrical Instrument Company	784
Wheeler-Green Electric Com- pany	774, 835
White Mfg. Company	855
Wholesale Radio Equipment Co.	840
Willard Storage Battery Com- pany	793
Wilmington Fibre Specialty Company	794
Wilson Utensil Company	776
Wireless Mfg. Co., The	794
Woodward & Lathrop	826
Workrite Mfg. Company, The	817
World Battery Company	796, 798
X Y Z	
Y. M. C. A. Radio Schools ..	746

I Can Qualify You as a Radio Expert in a Few Months!



Learn at Home Earn \$2500 to \$15000 a Year

Merle Wetzel, one of our students, reports that he is now making *three times* what he did before becoming a radio expert. Emmett Welch writes that after finishing his training, he made \$300 a month and all expenses. George Jones says "To your course I credit my present position as manager of this Radio De-

partment." Hundreds of other former students enthusiastically tell of their successes as radio experts! The field of Radio today is a real treasure house of wonderful opportunities. It offers rewards beyond your fondest dreams! Mail coupon today for Free Book just out—which explains in detail the amazing opportunities in this World's Fastest Growing Industry.

Hundreds of Big Paying Positions Waiting

Do you want to earn far more money than you ever dreamed possible? Do you want to be your own boss?—to have a profitable business of your own? Do you want to travel the whole world over—and make big money while doing so?

Radio offers you all of these opportunities—and more! Radio, the new infant industry; Radio, growing with leaps and bounds; Radio the field of endeavor with the most promising future of all!

Never in all history has an industry jumped into prominence so rapidly! Millions of dollars were spent last year on Radio. Hundreds of big money positions were created almost overnight. Thousands of men trained in Radio were needed. And the future holds even greater promise for those who enter this fascinating field. Learn more about what Radio can offer you.

Send for our new FREE BOOK on Radio.

Pick Out the Job You Want We Will Help You Get It

This is a brief list of the positions in the Radio field today, and the salaries paid:

- Radio Mechanic, \$1,500 to \$4,000 a year.
- Radio Inspector, \$1,800 to \$4,500 a year.
- Radio Salesman, \$2,000 to \$10,000 a year.
- Radio Engineer, up to \$10,000 a year.
- Radio Executives up to \$15,000 a year.
- Radio Instructor, \$200 to \$500 a month.
- Radio Draftsman, \$7 to \$15 a day.
- First Class Ship Operator, \$105 a month, all expenses paid.
- Commercial Land Station Operator, \$150 a month and up.
- Broadcasting Station Operator, \$125 to \$250 a month.

NOTE: RADIO FIRMS
Secure Practical Radio Experts
Among Our Graduates.

Write Today.

This Wonderful Free Book Has Shown Thousands the Way to Bigger Money

This Free Book has opened the eyes of thousands to the glorious opportunities in Radio. If you are ambitious—if you are looking for a field which offers *big money, fascinating work, advancement, and a real future*, send for this Free Book. It costs you nothing. You obligate yourself in no way. Yet this book can easily mean all the difference between the work you are doing now and wonderful success! Before you forget—mail the coupon NOW!

NATIONAL RADIO INSTITUTE
Dept. 13-M, Washington, D. C.



NATIONAL RADIO INSTITUTE
Dept. 13-M, Washington, D. C.

Without obligation on my part, please send me the free book "Your Opportunity in Radio", with full details as to how I can quickly train for the position of "Certified Radio-trician" in my spare hours at home. Also tell me how your free Employment Service will help me secure a good paying position, and about your special short time offer.

Name

Street

City State

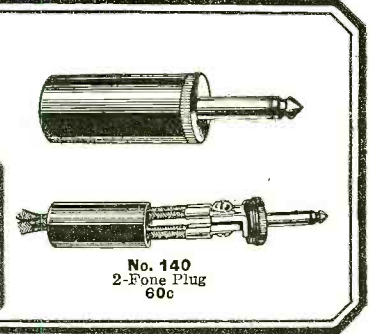
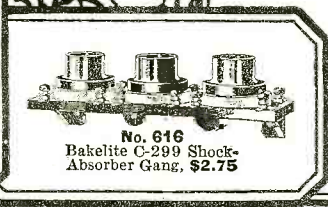
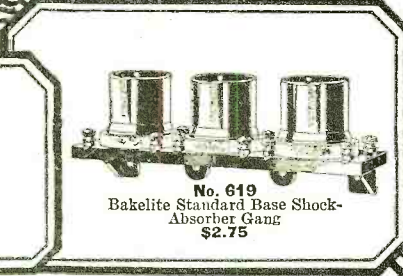
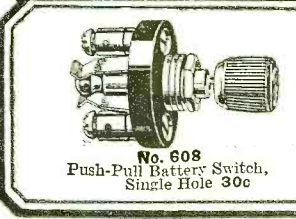
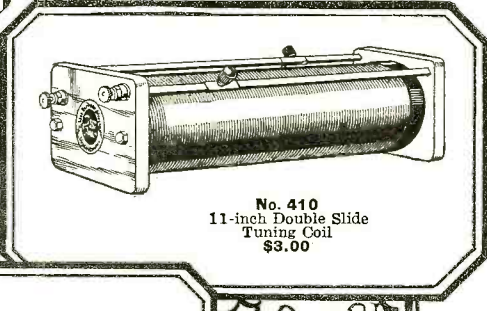
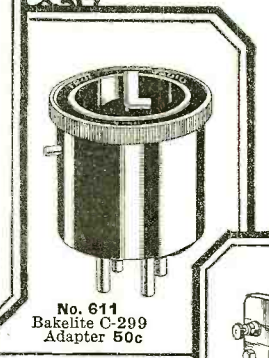
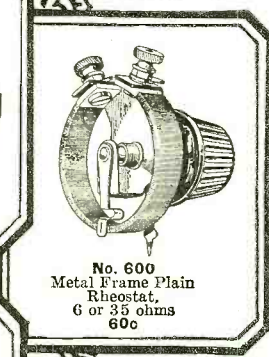
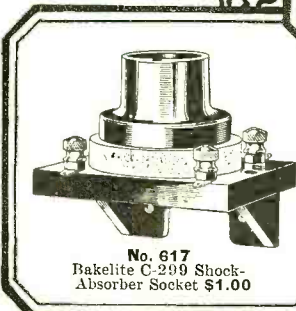
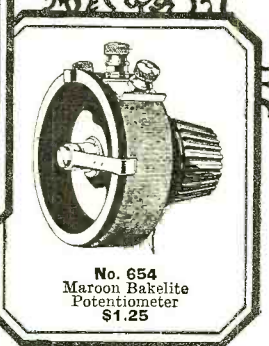
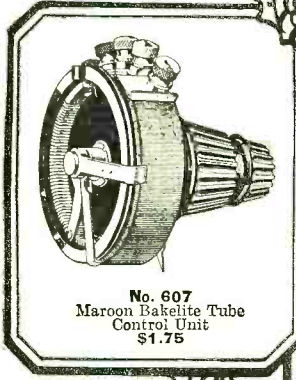

FROST

Ask Your

AT this glad season the hearts of America's millions of radio users doubly rejoice, for not only is radio reception at its best these cold winter nights, but the approaching holiday season offers a splendid opportunity for the Christmas giving of useful, practical radio apparatus which will provide endless entertainment and amusement throughout the entire year.

Whether for giving or "receiving" you will find **FROST-RADIO** ideal. As Christmas gifts the apparatus shown on these pages is supreme, combining highest quality with reasonable prices which only our vast quantity production make possible. For the radio receiving set **FROST-RADIO** brings unsurpassed results, due to correct design and superior construction.

HERBERT H.

154 WEST LAKE STREET,
30 Church Street

There is a Dealer Near

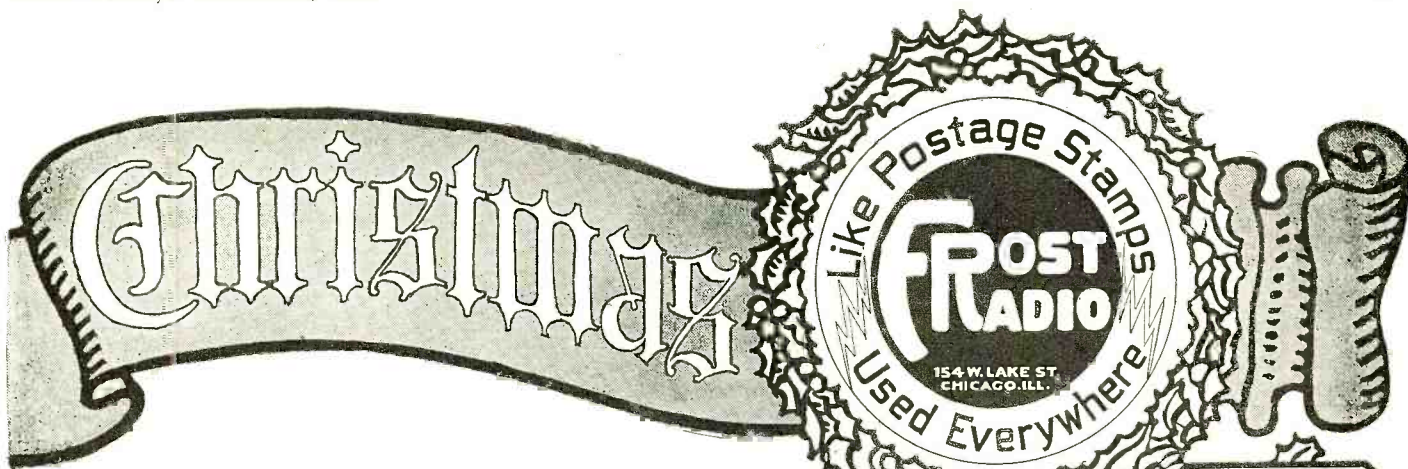

RADIO Neighbor

THE apparatus bearing the familiar **FROST-RADIO** name is sold by your dealer under the fairest, broadest, guarantee ever placed on similar apparatus by any manufacturer of radio. It *must* please you fully as to price, quality and service, and give you the satisfaction you have a right to expect.

We wish to call particular attention to the new **FROST-RADIO** items, which include aluminum shell and bakelite shell and cap **FROST-FONES**, Genuine Bakelite Tube Control Units, Plain and Vernier Rheostats, Potentiometers, Sockets, Adapters, Dials, Switches and Inductance Units. In addition to these note also the new Resistance Units, Plain and Vernier Metal Frame Rheostats, and No. 140 2-Fone Plug.

There is a **FROST-RADIO** dealer near you who can show you the complete line. See him today. He can supply this apparatus for your new receiving set.

FROST, Inc.

CHICAGO, ILLINOIS.

New York City

FROST-RADIO
Your Home



No. 172
3200 ohm
set, Maroon
Bakelite Shells
and Caps . \$6.00
No. 162—2000 ohm set
composition shells
and caps
\$5.00

FROST FONES
(Reg. U. S. Pat. Off.)

No. 172 Frost-Fones, in genuine maroon bakelite, with moulded-in terminal block, have no "lead" wires. Remarkably sensitive. No. 162, in composition shells and caps, are greatly improved. Hundreds of thousands in use.

No. 601
Metal Frame Vernier
Rheostat
6 or 35 ohms 75c

No. 650
Maroon Bakelite Plain
Rheostat
6 or 35 ohms \$1.00
No. 651
Vernier Rheostat, \$1.25

No. 630
35 ohm Resistance
Unit, adjustable
25c

No. 138
Multiphone Plug for
4-pair fones
\$2.50

No. 614
Bakelite Spider Dial
2 1/2-inch
50c

No. 501
4-fone Jac-Box,
complete as
shown
\$3.00

No. 618
Bakelite Std. Base Shock-
Absorber Socket \$1.00

No. 400
200-4000 meter
Receiving Transformer
\$9.50

No. 131
Double-Circuit Jack, 80c
(Made in all types at prices
from 60c to 90c)

No. 631
Bakelite Inductance
Unit \$2.50

No. 312
30 ft. Extension Cord. \$2.50

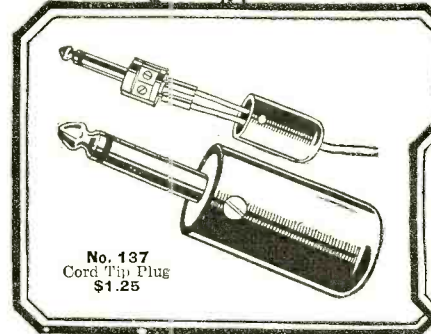

Travel Across the Country in Five Minutes



Licensed under Armstrong
U. S. Patent No. 1,113,149

WITH THE

ACE \$20

Type V **Armstrong
Regenerative
Receiver**

The Ace Type V Armstrong Regenerative Radio Receiver is without doubt the most popular of all sets. Its low cost is not indicative of its efficient service because it performs equally as well as any one tube radio set at any price.

The very first evening you enjoy the Ace Type V you'll wonder how you ever did without it.

Under ordinary conditions you can pick up stations from coast to coast, one after the other, with this long range regenerative receiver. A loud speaker can be operated in connection with the Ace Type V by simply adding an Ace Type 2B, a new two-step Audio Frequency Amplifier, which sells for \$20.00. This makes it possible to hear a concert all over the house.

This set is so low in cost that everyone can now afford to enjoy radio. Don't be without radio entertainment any longer—listen to the world's best talent—both instrumental and vocal.

If your dealer cannot supply you, order direct, mentioning his name. Ask for "Simplicity of Radio." Your copy is Free.

DEALERS:

Write on your letterhead for attractive sales proposition.

Prices do not include batteries, tubes or head phones. Buy these from your Dealer.

Be sure to come to the GRAND ANNUAL RADIO EXPOSITION, Coliseum, Chicago, and visit Booths on the Collonade, November 20 to 25th.

List price west of the Rockies 10 per cent higher. In Canada tariff added.

THE PRECISION EQUIPMENT COMPANY
POWEL CROSLLEY, JR., President
1222 Vandalia Avenue, Cincinnati, Ohio

Ace Type 3C Consolette

This is a new addition to the Ace Family. Has beautiful solid mahogany, wax finished cabinet. Set consists of a regenerative tuner, detector and two stages of Amplification, with built in loud speaker. The tuning circuit is licensed under the Armstrong U. S. Patent No. 1,113,149 and due to the particular method of winding Crosley coils it is exceptionally selective. Has sufficient room inside Cabinet for dry batteries, making a complete self contained long range receiving outfit. Phone jack for tuning with head phones; Crosley multistat; filament switch; Crosley moulded condenser; beautifully engraved formica panel. Uses all kinds of tubes. A wonderful set at a remarkable price \$125.000, without tubes or batteries.

The New Ace Type 3B

This set is equal to a combination of the Ace Type V and the Ace two-stage amplifier. Manufactured under Armstrong U. S. Patent No. 1,113,149. A filament switch eliminates necessity of turning out rheostats when set is not in use. You may turn off the set by throwing switch and come back later without retuning. Has telephone jack between first and second stage. Crosley Multistats, Universal filament control rheostats for all makes of tubes. Price \$50.00.

“Abroad at Home”

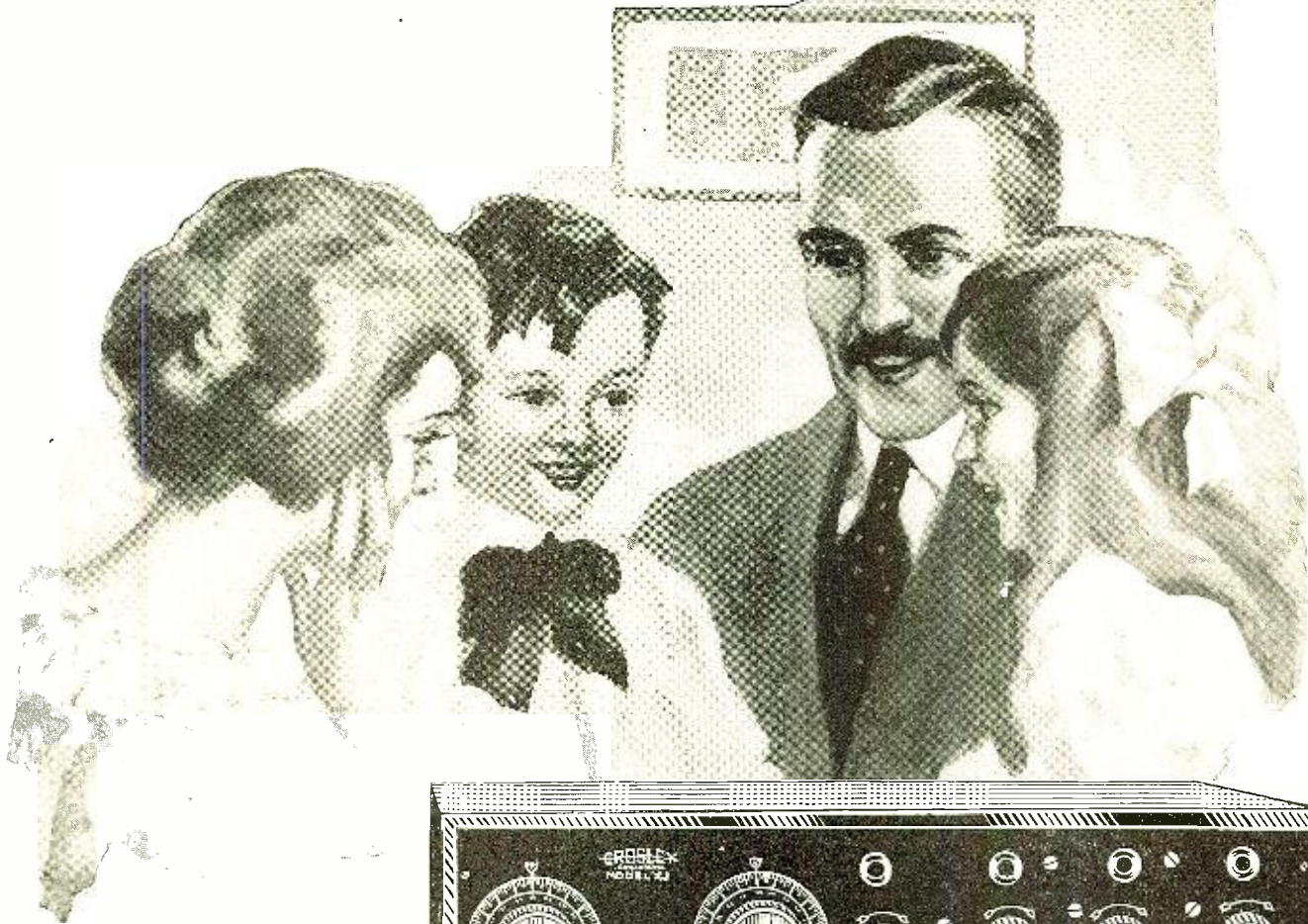

Where Shall We Go Tonight?

To New York, Cuba, Atlanta, San Francisco or perhaps Honolulu? Far distant stations are continually being brought in clearly and distinctly with a Crosley Model X-J. Unsolicited letters from users telling of new distance records are received daily. You, too, at a very small cost, can enjoy the many pleasures and conveniences that this new Crosley Model affords.

CROSLEY
Better - Cost Less
Radio Products

List prices on our equipment west of the Rockies 10 per cent higher. In Canada add duty.

WRITE FOR FREE
CATALOG

CROSLEY \$65
MODEL X-J

A 4 tube radio frequency set, incorporating one stage of Tuned Radio Frequency Amplification, Detector and two stages of Audio Frequency Amplification, with jack to plug in on three tubes for head phones; new Crosley multistats, universal rheostats for all makes of tubes; new condenser with molded plates; filament switch and other refinements of detail. This receiver is exceptionally efficient in long range reception. It will bring in stations at almost unbelievable distances clearly and distinctly.

We unhesitatingly claim the Model X-J is the best radio receiver ever offered, regardless of price.

The Crosley Model X-J together with the complete Crosley line of receivers ranging in price from \$28 to \$150 are for sale by best dealers everywhere.

CROSLEY MANUFACTURING COMPANY

POWEL CROSLEY, JR., President

1222 ALFRED STREET

CINCINNATI, OHIO

BUILD YOUR SET BETTER-AT LOWER COST

RUBBER COMPOUND PANELS

Made of a special compound having a rubber base. Equal in appearance and in all essential points to any other class of panels. Fine smooth polished finish. Can be drilled or cut without chipping. Guaranteed not to warp and to be a perfect insulator for radio use. Smooth, clean edges. Thickness 3/16 inch. Size given in inches.

F610 7x10...\$.88 **F615 7x18**...\$1.60
F611 7x12...1.05 **F616 7x21**...1.85
F612 7x11...1.22 **F617 7x24**...2.10

SUPER 180° VARIOCOUPLER
F521 Each...\$.98c
 A wonderful value, produces excellent results. Green silk windings on black fibre tubes. Rigid mounting support for table or panel mounting. Primary tapped for fine tuning. 1/4 inch shaft. Range 200 to 600 meters.

SUPERIOR VARIOCOUPLER
F523 Each...\$3.15
 A handsome instrument of superior design and construction. Stator tube and rotor ball of moulded red brown bakelite. Large size green silk windings insure highest efficiency. Table or panel mounting. 1/4 inch shaft. Superior results in circuits for 180 to 650 meters. Tapped primary for finest tuning. Noiseless contacts.

F526 Special single circuit type...\$3.60

SUPER MOULDED VARIOMETER
F412 Each...\$2.60
 Polished black moulded rotor and stator forms. Maximum inductance with greatest efficiency and minimum distributed capacity. A high grade instrument that will give the best results. Wave length 180 to 600 meters.

EXCEL MOULDED VARIOMETER
F524 Each...\$3.68
 A wonderful value at our price. Properly designed and constructed. Polished black bakelite rotor and stator forms. Large size. Green silk wire insures greatest efficiency. 1/4 inch shaft. Noiseless pistol connection. Table or panel mounting.

SUPERIOR VARIOMETER
F525 Each...\$4.45
 Forms moulded of red brown bakelite. A neat handsome instrument. Green silk windings calculated for highest efficiency. 1/4 inch shaft. Noiseless pistol connections. Table or panel mounting. Produces superior results in any type circuit 180 to 650 meters.

RADIO INDUCTANCE COILS
 Carefully made—fine looking coils. Highest efficiency. Low distributed capacity effect. Low resistance—high self inductance. Very firm impregnation. Range given in meters when used with .001 variable condenser. Mounted coils have standard plug mountings. Art. No. Art. Price

Turns	Range	No. Mtd.	No. Mtd.	Price
25	120-250	F301	F320	\$0.80
35	175-450	F302	F322	.94
50	240-720	F303	F323	1.00
75	390-910	F304	F324	1.06
100	500-1450	F305	F325	1.11
150	600-2000	F306	F326	1.15
200	900-2500	F307	F327	1.24
250	1200-3500	F308	F328	1.33
300	1500-4500	F309	F329	1.34
400	2000-5000	F310	F330	1.55
500	2800-6100	F311	F331	1.60
600	4000-10000	F312	F332	1.75
750	5000-12000	F313	F333	1.90
1000	7000-15000	F314	F334	2.25
1250	9750-19500	F315	F335	2.40
1500	14500-26500	F316	F336	2.55

INDUCTANCE COIL MOUNTINGS
F340-3 Coil. Ea. \$3.40
F341-2 Coil. Ea. 2.75
 Sturdy, rigid durable construction. Made of polished black bakelite. Mount on front of panel.

BACK OF PANEL MOUNTING
 Mounts back of panel, with knobs or dials on front of panel. Helps make a neat efficient set.
F342-3 Coil Back of Panel Mounting. Ea. \$4.45

STRANDED ANTENNA WIRE
 Cabled of fine copper strands. Very flexible. High tensile strength. Best for aerials.
F248 100 ft. coil 58c **F249** 500 ft. coil \$2.75

OUR SPECIAL VARIOMETER AND VARIOCOUPLER

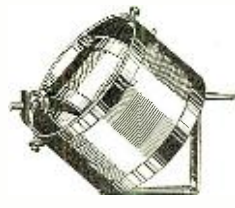

Build into your set reliable instruments. You can depend on this variometer and variocoupler to give you the best results in any circuit working from 180 to 650 meters. In design and construction they are the best. Only the highest grade materials are used. The prices quoted save you 30 to 40 per cent. Why pay more?

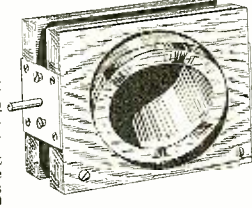

F418 Variocoupler. Each...\$2.45
 The most efficient type of coupler, insures better tuning and louder signals. Primary and secondary wound on natural uncolored genuine bakelite tubes. Handsome green silk windings. Primary tapped for fine tuning. Can be panel or table mounted. 1/4 inch shaft.

F410 Variometer. Each...\$2.10
 Perfect in design and construction. Accurate work forms thoroughly seasoned. Correct inductive ratios. Solid baked windings. Plenty of large sized wire insures highest efficiency. A strong high grade instrument that will give you lasting service. 1/4 inch shaft.

MAGNET WIRE

Insulated copper wire. Best quality even drawn wire, one piece to a spool. Prices quoted are for 8 oz. spools unless otherwise stated.

Double Cotton Insulation	Enameled Insulation	Green Silk Covered
Number F990	Number F992	Number F991
Gauge Price	Gauge Price	Gauge Price
1843c	2039c	20\$0.78
2055c	2250c	2295
2270c	2455c	24 1.10
2480c	2660c	26 1.38
2690c	3065c	30 (4 oz.) 1.25
28\$1.05	3270c	32 (4 oz.) 1.65
301.45	3690c	36 (4 oz.) 2.20

ANTENNA INSULATORS

F260 Size 1x3/4. Composition, metal eyelets. Two for mounting. Price .17c
F264 Size 1 1/2 x 1. For medium size aerials. Two for mounting. Price .69c
F265 Size 1 1/2 x 1 1/2. For large aerials. Two for \$1.28
F265 Ribbed Porcelain insulator. 1/2 in. long. Ea. 6c Dozen59c

LEAD-IN INSULATORS

F270 For 4 inch walls or less...42c
F271 For 2 inch walls or less...69c
 The only practical lead in insulator for aerial wires. Small, neat, effective, durable. Fits 5/8 inch hole. Securely locked by two adjustable nuts.

OUTDOOR LIGHTNING ARRESTER

F980 Price\$1.55
 Protect your instruments with this lightning arrester. Weatherproof porcelain case. Air gap type. Permanent. Durable. Underwriters approved.

HIGH-GRADE LIGHTNING ARRESTER

F981 Each79c
 A dependable protector, always on guard. Small and compact. Weatherproof porcelain case. Easily fastened and connected. Underwriters approved.

SPIDER WEB COILS

F290-25 turn. Each...39c
F291-35 turn. Each...42c
F292-50 turn. Each...47c
F293-75 turn. Each...54c
F294-100 turn. Each...59c
 A new popular type of inductance of highest efficiency. Lowest distributed capacity and lowest high frequency resistance. Firm green silk windings with fibre mounting strips.

COIL MOUNTING PLUGS

Made of genuine bakelite.
F344 Plug for mounting "honeycomb" inductance coils...39c
F345 Stationary plug to fasten mounted coil stationary to panel...42c
F346 Movable plug to fasten mounted coil to panel so it can be rotated...89c
F343 Fibre strip to hold coils for mounting. Two foot piece...15c

PANEL MOUNTING VARIABLE CONDENSERS

These are especially high grade condensers and we guarantee them to be mechanically and electrically perfect. Fine polished end plates of heavy bakelite. Shafts 1/4 inch diameter. Sturdy, heavy aluminum alloy plates perfectly spaced to insure smooth, even, reliable capacity. Our low prices save you money. These condensers are of the very best make and are not to be compared with many inferior, cheap condensers offered. We guarantee them to please you or your money back. The vernier style has one separately controlled plate which permits of the finest tunings.

REGULAR STYLE	VERNIER STYLE
F815-3 plate58c	Including Dial and Knobs
F816-3 plate97c	F825-14 plate .00025 mfd.\$2.45
F814-11 plate .00025 mfd.\$1.28	F824-26 plate .0005 mfd.2.75
F813-21 plate .0005 mfd.1.35	F826-46 plate .001 mfd.3.15
F812-43 plate .001 mfd.1.58	

OUR SPECIAL AUDIO FREQUENCY AMPLIFYING TRANSFORMERS

F550 Each...\$2.25
 The result of years of research work and experienced engineering. In quality of tone and volume of sound, the things a transformer is built for, we guarantee it to equal or surpass any other transformer. Neat in appearance. Carefully made. Fully mounted with plainly marked binding post connections. 5 to 1 ratio. Wonderful results on one, two or three steps without distortion or howling. A quality item in every respect. Not to be compared with articles built for price only.

OUR SPECIAL SHIELDED TRANSFORMER

F551-3 1/2 to 1 Ratio. Each...\$2.55
F552-6 to 1 Ratio. Each...2.75
 The same high grade style of transformer as above enclosed in a metal case which completely shields it from any outside magnetic influences. Very attractive appearance and sturdy construction. Free from howling and local disturbances.

THORDARSON AUDIO FREQUENCY AMPLIFYING TRANSFORMERS

F232 Ratio 3 1/2 to 1 \$3.40
F233 Ratio 6 to 1 3.80
 Recognized by leading radio engineers as the best balanced and most efficient transformer. Correct characteristics for any standard tube. Wonderful results without distortion on one, two or three steps. Plainly marked binding post connections on bakelite panel.

OTHER STANDARD BRANDS AUDIO FREQUENCY TRANSFORMERS

Fresh, clean stock in original containers.
F553 Acme. Each\$4.45
F554 Coto. Each4.45
F555 Federal. Each4.45
F712 Radio Corp. Each6.40
F234 All American 10 to 1 Shielded 4.15
F239 All American 5 to 1 Shielded 4.10
F236 All American 3 to 1 Shielded 3.95

RADIO FREQUENCY AMPLIFYING TRANSFORMER

F560 For 201A or 301A Tubes\$1.70
F561 For 199 or 11 or 12 Tubes\$1.70
 Due to its special design this transformer will produce wonderful results in any type of regular or reflex radio frequency circuit. While low in price we believe it equal or superior to higher priced transformers. Perfect for one, two or three stages. Compact, convenient form, easily mounted. Range 175 to 600 meters. Try it. If you are not satisfied return it and get your money back.

OTHER STANDARD BRANDS RADIO FREQUENCY TRANSFORMERS

F568 Our special—as good as any of them\$4.48
F562 Dubilier. Each4.45
F563 Coto. Each4.45
F564 Rasla. Each4.45
F565 Acme. First stage. Each4.45
F566 Acme. Second stage. Each4.45
F567 Acme. Third stage. Each4.45
F714 Radio Corp. Each5.95
F995 All American. Each3.95
F575 Eola. First stage. Each3.55
F576 Eola. Second stage. Each3.55
F577 Eola. Third stage. Each3.55
F578 Eola. Reflex. Each4.45

NEUTRALIZING CONDENSERS

F572 Per set of two40c
 Simple, inexpensive, effective precision type. Micrometer adjustment is attainable. Easily mounted in circuit.

SPECIAL

F573 Neutrodme Back. Each89c

LONG NOSE PLIERS

F970 Price .95c
 The handiest pliers for radio work. Made of fine hardened steel. Length, 5 in.

DIAGONAL JAW NIPPERS

F972 Price...\$1.05
 For fine electrical work, made of hardened steel. Length, 5 inches.

FOUR-IN-ONE SCREW DRIVER

F973 Each55c
 Especially suitable for radio work. Will handle any size screw used. Smaller drivers nest inside larger one and are held in place with screw cap. Made of steel, nickel finished.

TINOL

F969 Per Tube...1.9c
 A combined solder and flux in handy form. Put a little on the connection heat with a match, torch or solder iron and you have a neat electrically and mechanically perfect joint.

WITH BARAWIK STANDARD RADIO GOODS

VACUUM TUBES

Standard Brands—Cunningham, Radiotron. Every one guaranteed new and perfect. We will ship brand in stock unless you specify otherwise.

- F105 Detector, UV200 C300 Each \$4.39
- F112 Amplifier, UV201A C301A 5.85
- F118 6 Volt Transmitter, 7.70
- F107 WD11 C11, Each 5.85
- F101 WD12 C12, Each 5.85
- F102 UV199 (299, Each 5.85
- F104 UV199 Adapter fits 199 tube to standard socket42
- F108 WD11 Socket, Each31
- F109 WD11 Adapter, Each45

STANDARD TUBE SOCKET

F140 Each39c

Moulded of genuine red brown bakelite. Binding post connections. For table or panel mounting. Neat and strong.



METAL TUBE SOCKET

F146 Each39c

Strong durable socket for panel or table mounting. Metal tube and base. Plainly marked binding post connections well insulated.



TWO AND THREE GANG SOCKETS

These sockets make it easy to build detector and amplifier units and make a neat, compact workmanlike job. Perfectly made of high grade materials. Quickly mounted on panel or base.

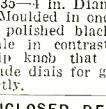

199 SOCKET

F145 Each49c

Moulded of high insulating material. Sponge rubber base prevents ringing in tube. Plainly marked binding post connections. Neat and compact.

FILAMENT CONTROL RHEOSTATS

- F132 6 ohm, Each45c
- F129 20 ohm, Each52c
- F131 30 ohm, Each59c
- F135 6 ohm Vernier95c

Best grade. Will give real service. Durable and lasting. High heat resisting base, diam. 1 1/2 in. Tapered polished black knob 1 1/4" diam.

POTENTIOMETERS

Match above rheostats. Same high grade construction.

- F151 200 ohm, Each79c
- F152 400 ohm, Each79c

SUPERIOR RHEOSTATS

- F153—6 ohm, Each69c
- F154—20 ohm, Each76c
- F155—30 ohm, Each83c

The finest rheostat. Smooth, even action. Best design, best workmanship. Supplied with attractive dial and knob. A rheostat for high grade sets.

QUICK ACTING RHOOSTAT

- F124—6 ohm, Ea.79c
- F125—15 ohm, Ea.88c
- F126—30 ohm, Ea.99c

Vernier adjustment at every degree of resistance. Pushing knob in turns off the filament.

THREE INCH DIAL

- F923 For 3-16 inch shaft. Each22c
- F924 For 1/4 inch shaft. Each22c

A handsome neat looking dial moulded in one piece of polished black composition. 180° scale marked 0 to 100 finely engraved in contrasting white enamel. Diameter 3 inches.

TWO INCH DIAL

- F921 For 3-16 inch shaft. Each16c
- F922 For 1/4 inch shaft. Each16c

A handsome neat looking one piece of polished black composition. 270° scale marked 0 to 100 finely engraved in contrasting white enamel. Fine for rheostat or switch control. Diam. 2 in.

VERNIER DIAL ADJUSTER

F941 Each19c

Easily installed at edge of dial, gives finest vernier adjustment of condenser or inductance. A great value. Polished black knob.

SUPERIOR RADIO JACKS

Finest grade jacks. Improved design. Best materials. Phosphor bronze springs. Silver contact points. Nickel finish. Mount on panels 1/2 to 3/4 in.

- F390 Open circuit, Each36c
- F391 Closed circuit, Each45c
- F392 Two circuit, Each54c
- F393 Single circuit filament cont.58c
- F394 Two circuit filament cont.74c

WE PAY TRANSPORTATION CHARGES EAST OF THE ROCKIES
PRESERVE THESE PAGES — ORDER FROM THEM AND SAVE MONEY
FAST SERVICE — TRY US AND BE CONVINCED
THE PRICES QUOTED DELIVER THE GOODS TO YOUR DOOR

OUR GUARANTEE PROTECTS YOU—We handle only the best goods, carefully tested and checked by expert radio engineers. You are assured of getting guaranteed apparatus that will give superior results. And while our goods are best, our prices are lowest. Our goods equal or surpass the claims we make for them. We do not attempt to deceive or mislead. Our reputation for fair dealing is our most valued asset.

HOW TO ORDER—Write your Order plainly, state Article Number, Description and Price of items wanted. Send Postoffice or Express Money Order, Certified Check or Bank Draft for Total of Order. Prompt Shipment is assured when these directions are followed.

BAKELITE DIALS

- F931—2 in. Diam. for 3-16 in. shaft, Each35c
- F932—2 in. Diam. for 1/4 in. shaft, Each35c
- F933—3 in. Diam. for 3-16 in. shaft, Each39c
- F934—3 in. Diam. for 1/4 in. shaft, Each39c

F935—4 in. Diam. for 1/4 in. shaft, Ea.43c

Moulded in one piece of genuine bakelite in polished black finish. Finely engraved scale in contrasting white enamel. Sure grip knob that fits the fingers. Higher grade dials for good sets. Sizes match perfectly.



ENCLOSED DETECTOR

One of the finest crystal detectors on the market, supersensitive galena crystal enclosed in heavy glass shield. Quick, positive adjustment. Brass parts polished nickel finish.

F730 Each89c

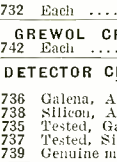

GALENA DETECTOR

Easy fine adjustment. Crystal mounted in cup. Moulded base and knob. Brass parts polished nickel finish. An unequalled value.

F732 Each59c



GREWOL CRYSTAL DETECTOR

F742 Each \$1.69

DETECTOR CRYSTAL CAREFULLY TESTED

- F736 Galena, Arlington tested, piece 19c
- F738 Silicon, Arlington tested, piece 19c
- F735 Tested, Galena, Mounted, piece 9c
- F737 Tested, Silicon, per piece8c
- F739 Genuine million point crystal, Ea. 29c

SUPERIOR VARIABLE GRID RESISTANCE

- F167 Each80c
- F168 With .00025 Condenser95c

Eliminates hissing, clarifies signals. Capacity smoothly varied from 0 to 6 megohms by half turn of knob. Easily mounted on any panel.

F171 Freshman panel mounting variable grid leak with .00025 condenser, Each 69c

F172 Durham variable grid leak with mounting, Each89c

F173 CRL Variable grid leak, Each \$1.19

TUBULAR GRID LEAKS AND CONDENSERS

Very convenient. Permit of quick change of leaks or condensers of varying capacity. Cut shows leak mounted. Leaks and condensers have same appearance. Each part priced separately.

- F849 Grid Leaks, Each18c

Resistances—1/2, 1, 1 1/2, 2, 3, 5, 7, and 10 megohms. Specify which size is wanted.

F831 Grid and Plate Condensers, Ea. 39c

Capacities—.00025, .0001, .00025, .0005 mfd. Specify which size is wanted.

VARIABLE GRID LEAKS

- F161 De Luxe style with extra heavy screw top finely finished32c

Pencil mark typo for Panel mounting. Resistance may be varied exactly as needed.

BARAWIK QUALITY HEADSETS

F770 Per Set, 2000 ohms \$3.25

These headsets have proven on rigid tests to be one of the very best on the market. The tone quality is excellent with an unusual volume. Skilled workmen make them from only the best selected materials. The receiver cases are fine polished finish with polished black ear pieces. Fabric covered head band comfortably and quickly fitted to the head. Supplied with 5-foot cord. These sets were designed to sell for much higher prices than we ask, and at our price are a wonderful bargain. We guarantee that you will be pleased with them and agree that they are the best value by far yet offered. If they don't suit you we will cheerfully return your money.

STANDARD BRAND HEADSETS

- F754 Baldwin Type C with universal jack plug \$1.75
- F756 Red-Head, 3000 ohm 5.78
- F768 Brandes, 2000 ohm 5.35
- F769 Brandes, 3000 ohm 6.90
- F751 Murdock 56, 2000 ohm \$3.59
- F752 Murdock 56, 3000 ohm 3.95
- F764 Frost, 2000 ohm 3.59
- F766 Frost, 3000 ohm 4.15
- F758 Western Electric 9.50

GRID CONDENSERS

- F162 Well insulated. Paper covering. Each7c
- F163 Highest grade. Mica insulated. Polished nickel case. Each23c

Fit over points of above leaks. The combination makes an efficient unit. Cap. .00025 mfd.

STANDARD BRAND LOUD SPEAKERS AND UNITS

- F610 Murdock \$4.38
- F611 Rico 4.85
- F613 Barawik with Baldwin unit. 9.95
- F615 Pathe 16.50
- F616 Atlas 32.50
- F612 Magnavox R3 32.50
- F614 Magnavox M1 27.00
- F617 Music Master 5.35
- F755 Genuine Baldwin type C Unit 5.35
- F619 Barawik Special Unit 2.60

COMPETITOR JACKS

- F387 Open circuit, Each27c
- F388 Two circuit, Each35c

Well made, durable, smooth working, nickel finished frame. Well insulated.

SUPERIOR RADIO PLUGS

- F395 With set screws for fastening. cord. Each35c
- F397 Two-way — takes two pair any style cords. Each59c

Highest grade plugs. Fit any standard jacks. Polished round barrels.

SWITCH CONTACT POINTS

Brass polished nickel finish. All have 1/8 in. long size 6-32 screws and two nuts. All prices the same.

- Dozen Hundred \$1.00

Order by Article Number.

- F360 Head, 1/4" diam.; 1/4" high
- F362 Head, 3-16" diam.; 1/4" high
- F363 Head, 5-16" diam.; 1-16 high

Solder Lugs to Fit Contact Points

Also for connecting wires to binding posts. etc.

- F365 Dozen 8c Hundred 30c

SWITCH LEVER STOP

Brass polished nickel finish.

- F386 Dozen 18c Hundred \$1.05

SWITCH LEVERS

Very neat polished black composition knob. Exposed metal parts polished nickel finish. Fitted with panel bushing and two set nuts. A high grade switch.

- F381 1 1/4" Radius, Ea. 15c

INDUCTANCE SWITCH

F385 Price including knob and dial. \$1.29

Mounts switch points and contact lever behind panel. Only one hole needed to mount. 15 switch points, any number of which may be used. Smooth wiping contacts. Attractive tapered knob.

BINDING POSTS

Brass, polished nickel finish. Washer and 6-32 in. screw extending 3/4 in.

- F370 Large size—barrel and knob 3/4" long. Dozen85c
- F372 Smaller size barrel and knob 9-16" long. Dozen70c
- F374 Large size with composition knob. Dozen45c
- F376 Large size with hole for phone tip or wire. Dozen80c
- F378 Small size with hole for phone tip or wire. Dozen35c

SUPERIOR INDUCTANCE SWITCH

F384 Each74c

Quickly and securely mounted by drilling one hole. Only knob and pointer show in front of panel. Connections can be soldered before fastening switch, making assembly much easier. Metal parts nickleplated. Bakelite knob and supporting base.

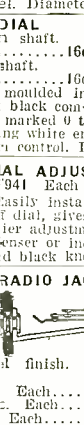

PLATE CIRCUIT "B" BATTERIES

You can make real savings on these batteries. Don't pay more. We guarantee them to equal any on the market regardless of price. Absolutely uniform. Extra long life.

- F180 Signal Corps type, small size, 15 cells, 22 1/2 volts, Each \$1.10
- F182 Large size, 5 taps 16 1/2, 18, 19 1/2, 21 and 22 volts, Each \$1.59
- F184 Variable Large Navy size, 16 1/2 x 4 1/2 inches 5 taps, giving range from 16 1/2 to 22 1/2 volts in 1 1/2 volt steps, Each \$1.95
- F186 Combination Tapped 45 volts, 39 cells, 15x3x3 battery, Tapped to give 45, 22 1/2, 21, 19 1/2, 18 and 16 1/2 volts. Handles both detector and amplifier tubes. Ea. \$3.65

STORAGE "A" BATTERY

A very high grade battery made especially for radio service. Guaranteed for three years. Properly cared for will give many more years of service for filament lighting. Made of best new materials. Full capacity. The best battery buy on the market. Try one of these batteries on your set for 10 days. If at the end of that time you are not fully satisfied with the battery return it and we will refund the purchase price.

- F194 6 volt, 40 ampere size, Each \$0.75
- F196 6 volt, 50 ampere size, Each 19.25



HOMECHARGER BATTERY CHARGING RECTIFIER

Charge your battery at home overnight for a few cents. Simply connect to any 110 volt 60 cycle light socket, turn on current and rectifier does the rest automatically. Will work for years without attention. Simple connections. Gives a tapering charge which batteries like. You can make it pay a profit charging your friends' auto batteries. Long connecting cords with built in battery clips.

- F201 For 6 volt battery. \$12.95
- F203 For 12 volt battery. 12.95

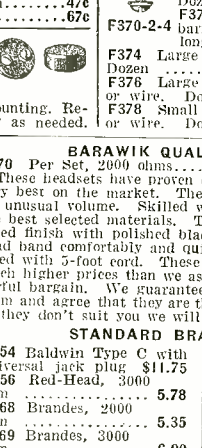

RADIO "BAKELITE" PANELS

Notice our very low prices on this fine quality material. Others ask as much for hard rubber panels which are worth much less. We supply genuine Bakelite. Condensite Celoron or Formica, all of which are materials with practically identical mechanical, chemical and electrical properties. Machines well without chipping. Won't warp. Waterproof. Highest mechanical and dielectric strength. Attractive natural polished black finish which can be sanded and oiled.

Panel Size Inches	1/8" thick	3-16" thick	1/4" thick
Art. No.	Price	Art. No.	Price
6x7	F450 \$0.57	F460 \$0.86	F470 \$1.15
6x10 1/2	F451 .86	F461 1.27	F471 1.73
7x14	F458 1.38	F468 2.07	F478 2.76
7x18	F453 1.78	F463 2.65	F473 3.56
7x21	F457 2.05	F467 3.05	F477 4.10
7x24	F459 2.42	F469 3.56	F479 4.56
9x14	F454 1.85	F464 2.65	F474 3.56
12x14	F455 2.42	F465 3.56	F475 4.78
12x21	F456 3.62	F466 5.35	F476 7.13

CABINETS

Fine looking cabinets solidly built. Elegant hand rubbed dark mahogany finish. You will be proud of your set mounted in one of these cabinets. Hinged tops. Front rabbeted to take panels. Panels not included. Prices are transportation paid.

Panel Size	Inside High	Dimensions Wide	Depth	Art. No.	Price Each
6x7	5 1/2"	6 1/2"	7"	F420	\$2.15
6x10 1/2	5 1/2"	10"	7"	F422	2.65
7x10	6 1/2"	9 1/2"	7"	F421	2.90
7x12	6 1/2"	11 1/2"	7"	F424	3.05
7x13	6 1/2"	13 1/2"	7"	F423	3.20
7x18	6 1/2"	17 1/2"	7"	F426	3.45
7x21	6 1/2"	20 1/2"	7"	F425	3.85
9x13	8 1/2"	13 1/2"	10"	F429	4.65
9x14	11 1/2"	13 1/2"	10"	F428	3.55
12x21	11 1/2"	20 1/2"	10"	F432	4.65

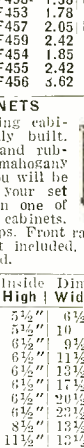

THE BARAWIK CO. Chicago's Original Radio Supply House Beware of Imitators **102 South Canal St., Chicago, Ill.**

The Proof of the Pudding!

900 MILES

Gentlemen: I have one of your Monodyne Tube Sets Model GT-1. I think it a wonderful set. Have heard about 900 miles during the last few days but expect to get much farther when the weather will permit. I would like to put this set in stock, so I am writing for territory and dealer's discounts. Hoping to hear from you. I best to remain.

Leslie M. Wallace,
Holstein, Iowa.

"ALL VERY CLEAR"

Last night I got WGY, WDAP, WLW, WCX, WJZ and WHAS. On the night previous I got WHAZ of Troy, N. Y., and WOS of Jefferson City, Mo., as well as WDAP, Kansas City Star, all very clear although not loud. One evening last week I got WEA of your city. My longest distance so far is WSR of Atlanta, so am satisfied with the receiving range of the set. And believe that with even one stage of amplification could double the range without trouble.

H. H. Martin,
1815 Denuene Avenue,
Columbus, O.

UNDER OATH

ATLANTA, GEORGIA, Fulton County. Personally appeared before me Mr. R. D. LeRoy, who on oath and by original of the above shown, declared this to be an exact copy of an unsolicited testimonial presented to the Electric Shop, by Mr. D. H. McCalla, sworn to and subscribed to before me this 25th day of September, 1923.

The list of stations heard by Mr. McCalla include KDKA, Pittsburgh, Pa.; KFKZ, Minneapolis, Minn.; KYW, Chicago, Ill.; WDAP, Kansas City, Mo.; WDAP, Chicago, Ill.; WJAK, Stockdale, Ohio; WLW, Cincinnati, Ohio; WMC, Memphis, Tenn.; WOAR, Philadelphia, Pa.; WOC, Davenport, Ia.; WOS, Jefferson City, Mo.; WOH, Newark, N. J.; WOO, Philadelphia, Pa.; WEA, New York, N. Y.; WJAX, Cleveland, Ohio; WOAW, Cleveland, Ohio; WSAI, Cincinnati, Ohio; WJAZ, Chicago, Ill.; WNAV, Knoxville, Tenn.; WFL, Philadelphia, Pa.; WGR, Buffalo, N. Y.; WGY, Schenectady, N. Y.; WIP, Philadelphia, Pa.

Yours truly, (Signed) D. H. McCalla.

1000 MILES

Gentlemen:— Having purchased your Monodyne set I was more than pleased over the results obtained from it. I think it is one of the best one-tube sets on the market today.

I have heard the following long distance stations—WDAP Kansas City, WDAP Chicago, WSB Atlanta, WOO Philadelphia, WGY Schenectady, WOC Davenport, and a Canadian station whose call letter I could not obtain.

Tuning hook-up No. 4 gives very selective tuning and volume. Your set cannot be praised too highly.

William Brown,
65 East 117th St., N. Y. C.

"LOUD AND CLEAR"

Dear Sirs:— The National Monodyne is all which you claim it to be. Up to date I have received the following stations loud and clear: WSAB, Fall River; WTAB, Fall River; WMAF, South Dartmouth; WNAC, Boston; WBZ, Springfield; WGY, Schenectady; WJAR, Providence; WEAN, Troy; WEA, New York; WJZ, New York; WJY, New York; EDKA, E. Pittsburgh; WDAP, Chicago, and another 350-meter whose call letters I couldn't get.

William H. Burns,
19 Buckley St.,
Fall River, Mass.

"A LITTLE WONDER"

Dear Sirs: I have received as a present a National Monodyne Tube Set. The following is a list of stations which I have received with this set so far: WJZ, WRW, WOH, WEA, KDKA, WBZ, WGY, WJAZ, WDE, WDAP, WOO, WIP, WGI.

These stations were heard in New York, also in a place thirteen miles from Albany.

I think this set is a little wonder.
Rosario De Bello,
538 West 179th St.,
New York.

"A WONDER"

Gentlemen— Received your Monodyne set in perfect condition, and I must say that it is a wonder. Tuned in on KFI, The Times, Los Angeles. Static was absent in the reception. The program was clear as a bell. I am using a C-299 tube.

Louis Jones,
543 First Ave.,
Yuma, Ariz.

"REMARKABLE RESULTS"

Dear Sirs:— Being an amateur of the first order, I was rather surprised with the remarkable results obtained last evening on your Monodyne. Local music came in clear and loud and the light returns were perfect. Later in the evening fairly good results were obtained from Chicago, Schenectady and the Hotel Adelphia in Philadelphia. Undoubtedly after I am more familiar with the set even better results are in view.

R. H. Cherry,
30 Church St., New York City.

TRULY AMAZING

Gentlemen:— We live in a wooded part of the tide-water section of Virginia. When the Monodyne arrived, with the help of a little plantation dorky we erected our aerial, running it from the top of an iron frame wind mill to a corner of the porch.

We confess that we were a little skeptical about it, as it was during an excessively hot spell in the early part of August—a condition which we understood to be very unfavorable to radio reception—that the set arrived. The results, however, were truly amazing. We heard Chicago, Atlanta, Schenectady, Cleveland, and other stations—over distances ranging from 500 to 850 miles—and every station came in loud and clear.

We think that you will be pleased to know of the really wonderful work your little set is doing down here.

Mrs. Henry Williams,
Sherwood, Gloucester County, Virginia.

NATIONAL

MONODYNE

PAT. TRADE MARK PDG.

TUBE SET

MODEL GT-1

\$10.00 WITHOUT TUBE

Including Two Interchangeable Inductance Coils for Wave Lengths ranging from 200 to 600 meters



A LITTLE WONDER

Gentlemen: Just a word about your Monodyne Tube Set. I have heard the following stations: KDKA, WCAP, WOAW, WWJ, WJAZ, WOC, KYW, WCAP, WEA, WJZ, WGY, WHB, WOS, WDAP.

This makes fourteen stations in only a few nights listening in, and they were all loud and clear—more so than a single circuit regenerative set, (which by the way will not function at all on my aerial.)

Earl S. Kirk,
P.O. Box 336, Marion, Ind.

"TOO LOUD"

Your National Monodyne arrived Sept. 18, 1923 and in one week's time I have heard the following: Joplin, Mo., Chicago, two stations, Detroit, two, Cincinnati, one, Louisville, one, Pittsburgh, two, Cleveland, one, Philadelphia, two, New York City, two, also Troy, N. Y., Canton, N. Y., Providence, R. I., Washington, D. C. and last but not least WGY comes in too loud. I have no trouble to tune out any station.

Clyde G. Swartz,
Bellefonte, Pa.

"WONDERFUL"

Gentlemen—A friend of mine just purchased one of your Monodynes, and I tell you it is wonderful. He has received WGY, Schenectady, N. Y., WOC, Davenport, Iowa.

J. O. Noble,
3503 1/2 W. Madison St.,
Louisville, Ky.

USES NO AERIAL

Dear Sirs:—The other day I bought one of your sets in Chicago. Perhaps you will be interested to know, that I put the set in operation tonight by using a "Ducon" plugged in a socket in the wall, on the sixth floor and heard the announcers at Davenport, Iowa, and Chicago also singing at latter place very distinctly, but not a speaker at former place clear enough to understand the talk.

Then tried with a seventy-five foot wire thrown out the window and heard Minneapolis, the announcer distinctly but not the singing and talking. Lot of static. Omaha very plainly.

Clarence J. Berlew,
2683 Briggs Ave.,
New York City, Bronx.

• The MONODYNE Circuit is one of the most radical advances in radio engineering since the advent of the Armstrong Circuit.

Parts heretofore considered essential are omitted and one simple tuning control gives a selectivity equal, if not superior, to that of sets costing hundreds of dollars. A child can operate it.

No more hunting for stations. You know in advance at what point of the scale your favorite station is located—only the highest price sets accomplish this.

Dealers, Jobbers and Distributors—Send for Samples and Prices

SEND NO MONEY

National Airphone Corporation, B.N. 12
18 Hudson Street, New York City, N. Y.

Gentlemen: Please send me prepaid One (1) NATIONAL MONODYNE tube set, Model GT-1, for which I will pay the postman \$10.00.

NAME

STREET AND NO.

CITY STATE

NATIONAL
AIRPHONE
CORPORATION
18 HUDSON ST. NEW YORK

NATIONAL Interference Eliminator

Adds selectivity to your set.

Tunes out side waves or harmonics of powerful broadcasting stations.

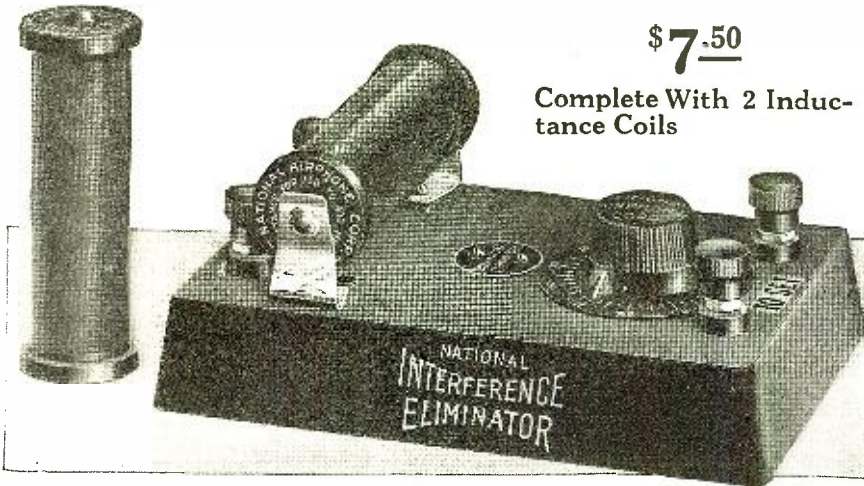

\$7.50

Complete With 2 Inductance Coils

Will make your set tune sharper.

Two coils go with instrument, one for short and another for long wave lengths.



The National Interference Eliminator can be used with all radio outfits no matter what make, tube or crystal. Will bring in stations you never heard before. Nothing else required with set as illustrated. Just connect it with two short wires to your outfit.

A NATIONAL STANDARD INSTRUMENT OF MERIT AND RELIABILITY

Eliminates Broadcasting and Code-Signal Interference
Can be used to increase or shorten Wave Lengths

AN ABSOLUTE NECESSITY TO CLEAR RECEPTION

NATIONAL AIRPHONE "GOLD-GRAIN" DETECTORS

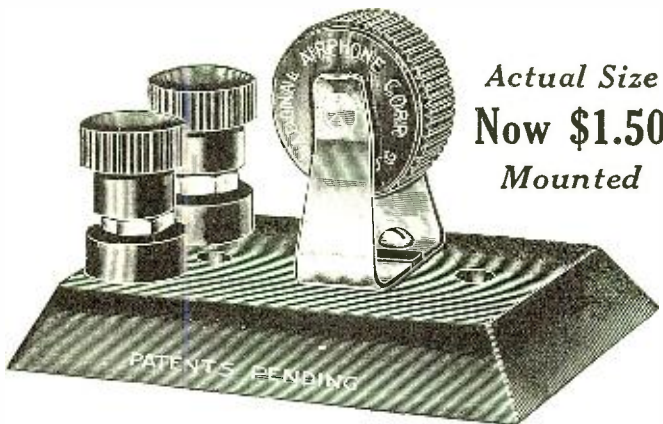

Actual Size
Now \$1.50
Mounted

After you have fussed with catwhiskers, springs, balls and adjustment handles, and after you have almost become a nervous wreck, hunting for "the elusive sensitive spot"—you will welcome with open arms our 100 per cent. GOLD-GRAIN DETECTOR.

This Detector is foolproof; has no catwhiskers; no springs, no balls, no adjusting handles; no fussing. The detector is entirely enclosed in hard rubber composition cartridge, but it is NOT a fixed detector.

A special crystal is used, while contact elements are made of pure gold. There is always a multiplicity of contacts. The Detector is sealed hermetically. The contact with the crystal is always perfect.

This detector has been pronounced by experts as the greatest detector in existence. It reproduces voice, and music in natural color of tone, without distortion. You will be surprised at the wonderful results and satisfaction obtained with the "GOLD GRAIN" Detector.

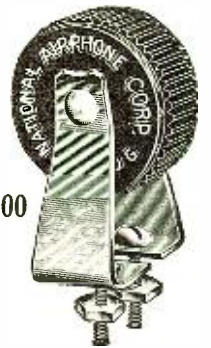

\$1.00

Actual Size
FOR PANEL MOUNTING

Most Practical for Reflex and Crystal Sets

Dealers, Jobbers and Distributors—Send for Samples and Prices



NATIONAL
AIRPHONE
CORPORATION

20 HUDSON ST.

NEW YORK

SEND NO MONEY

National Airphone Corporation
20 Hudson Street, New York City, N. Y.

R. N. 12

Gentlemen:

Please send me prepaid the articles crossed, for which I will pay postman upon delivery the advertised price.

One National Monodyne
One Interference Eliminator
One Panel Detector

NAME

STREET

CITY STATE



The little button projects to warn, "I'm ON—do'n't forget me!" Saves both tubes and batteries.



The C-H Radio Switch can be installed on any panel in only a few minutes. Just one 7-16 inch hole is required. Large, convenient binding posts with cupped washers make wiring easy.

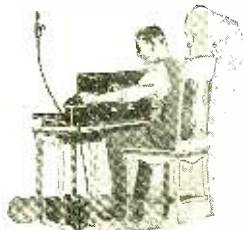

The heavy capacity of the C-H Radio Switch makes it suitable for a great number of radio control applications. Its perfect mechanism is the result of more than fifteen years' development by the famous C-H engineers, specialists in electrical control.



The Genuine Cutler-Hammer Radio Switch is sold only in the orange and blue carton, marked plainly with the C-H Trade mark. There is no substitute—even the Cutler-Hammer engineers could not build a switch to meet radio requirements and sell for less.

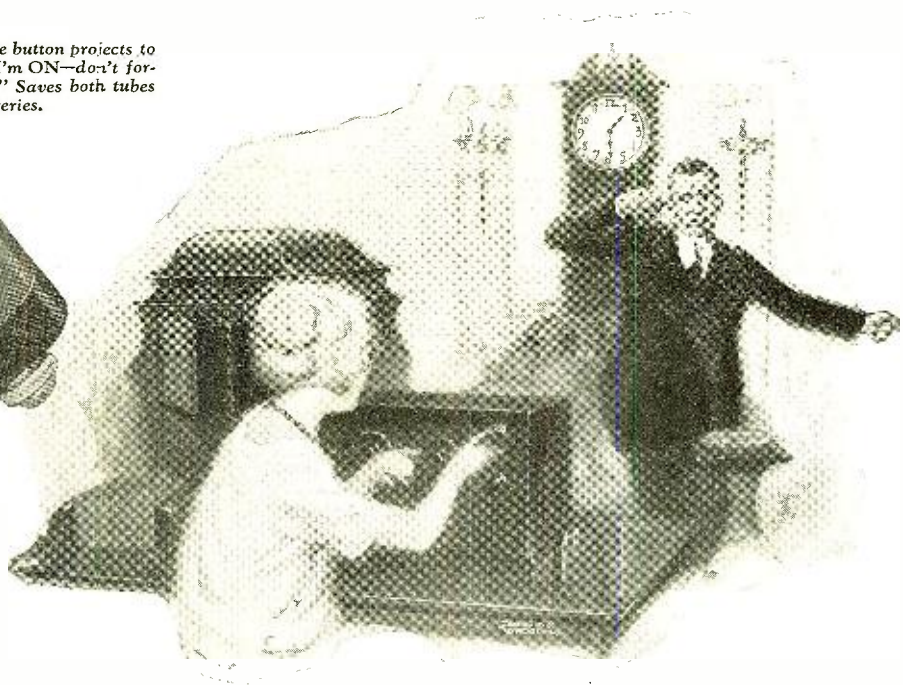

If You Use the New Tubes You Certainly Need This C-H Switch

There is No Filament Glare to Remind You When the Current is ON—The Little Nickeled Button Takes Its Place

There is no easier, safer way to protect *any* tubes than by placing a C-H Radio Switch directly in the "A" battery circuit. Then you can always be certain, when you push in the sparkling nickel button, that the current is *completely off* throughout the set.

But with the new tubes, this little convenience becomes a necessity. There is no filament glare to remind you, and unless a C-H Radio Switch button projects to say, "I'm On, don't forget me," you may easily do so at the cost of tubes and batteries.

See your dealer today. Have him show you the Radio Switch in the orange and blue box—and look for the C-H trade mark. Then you can be sure that it has the famous C-H wiping knife-blade contact that cleans itself and holds a perfect connection so as not to introduce microphonic noises when used in the most delicate circuits. It only takes a few minutes to install on any panel and adds hours of pleasure. If your dealer is not yet stocked, send 60c plus 10c for packing and you will be supplied promptly.

THE CUTLER-HAMMER MFG. CO.

Member Radio Section, Associated Manufacturers of Electrical Supplies

MILWAUKEE, WISCONSIN



RADIO SWITCH



RADIO NEWS

H. GERNSBACK—Editor and Publisher
ROBERT E. LACAULT—Associate Editor

EDITORIAL AND GENERAL OFFICES, 53 PARK PLACE, NEW YORK

Vol. 5

DECEMBER, 1923

No. 6

Simplifying Radio

By H. GERNSBACK

WHEN we look back 20 or 25 years and contemplate the radio equipment of the vintage of 1900, we smile, or perhaps laugh outright, all according to our individual temperaments. We look on our 1-K.W. thunder factories with their rock-crushing equipment and marvel why there ever was such a display of metal and various sundry materials. But the radio receivers of the year 1900 are the ones that catch most of our attention. In order to hear the long distance call of the thunderous 1-K.W. station located 3 miles and 55 yards to the starboard side of us, we required an outfit with at least 25 different pieces of apparatus, not to speak of batteries, choke coils, metal lined boxes to keep out the waves set up by the decoherer, and a four-wire aerial, several hundred feet long. It took days to adjust such a receiver, and only an expert could handle such a set. There were more nuts and binding posts in the wireless receiving set of 1900 than you can find in a well stocked small radio store today.

Since that day we have improved the ancient outfit somewhat and we pat ourselves on the back and smile contemptuously at Marconi's first endeavors. We look at our present day outfits and say to ourselves that here at last is something worth while.

As a matter of fact, we should creep into a hole and weep, for the improvements which look wonderful to us, since 1900, are still very mediocre. Imagine the smile of the man who takes up this issue of RADIO NEWS 25 years hence. He certainly will have a good laugh at our present day radio atrocities, and he will not, for the life of him, understand why we ever did what we are doing right now.

It is all very well to sit back complacently and say that the millenium in radio has finally arrived, when as a matter of fact, we are perhaps a million years away from it. Just as we have simplified our apparatus and its action during the last 25 years, in this same degree we will simplify all radio apparatus in the future.

We have mentioned editorially before that the days of the huge generator, transformer and tremendous spark gap, that are in our large sending stations, are numbered. We have stated that during the next five years these thunder factories will be scrapped and that the entire plant which takes up acres today will be located in an office building in a room less than 20' square. There will be no noise and you will hear no sound, as all the sending will be done by powerful electronic tubes. Even the amateur 10 years ago had a noise factory all his own. We were using large spark coils or transformers; big spark gaps, either stationary or rotary; a sending inductance, called a helix, 2' high and 1' in diameter, along with many other cumbersome condensers and a host of other paraphernalia. Compare this to the small tube transmitter of today, which does not take up more room in its entirety than the old-fashioned helix. And so it goes.

The public still seems to have the erroneous idea that in order to get its money's worth, it must be handed a big box with at least 10 dials and a few gross of knobs thrown in for good measure.

Our vacuum tubes are still the size of a child's fist when it has already been demonstrated for years that a tube, smaller in diameter than a pencil and 1" high, will do the work just as well.

As a matter of fact, we believe that the vacuum tube, although remarkably good today will eventually be found only in industrial works. But it will have no place in radio reception. Other devices will take the place of the vacuum tube, as the coherer made way for the detector, and as the detector made way for the vacuum tube.

Speaking of vacuum tubes, it may interest many to know that a Holland manufacturer is now making vacuum tubes filled with argon, which, at a pressure of 30 volts, works as well as the pres-

ent tube at 100 volts. Its life is about 1,000 hours without change in its characteristics. One of these used for transmitting does the work of four, with only 200 volts on the plate.

Then we have our good old friends the rheostat and the potentiometer, with which we garnish our present day outfits. You may rest assured that five years from now, rheostats will no longer be known in connection with vacuum tubes. Either the vacuum tubes themselves will have a device to adjust the filament voltage automatically, or all outfits will be provided with automatic regulating ballasts. Some such devices are already making their appearance. It is a nuisance today, and always has been, to adjust the filament voltage by hand. Rheostats in the future will be recognized as a monument to inefficient or incorrectly designed tubes.

Next, we have our good old chum the inductance switch (tapped), a monstrosity of the first caliber. Being such, no self-respecting first-class radio outfit today would be without one or more of these switches. As a matter of fact, the more the better, because each switch adds "value" to the outfit in order to tag on an extra \$10. To be sure, there are several outfits on the market today that get along excellently without the tapped switch, which latter, by the way, acts like a first-class sieve, losing the little energy that comes in over the aerial. A variable condenser used in connection with the inductance (tuning coil) is far better in all respects than taps and a switch. Up-to-date manufacturers are doing this now. A good article on this phase appeared in the last issue of RADIO NEWS.

Most every up-to-date outfit has a number of variocouplers, variometers, and at least a quart of variable condensers, in order to make a respectable appearance. One of these days, and not in the far future either, it will be found that an outfit can get along without all this paraphernalia. It will be found that one, and perhaps two fixed coils are all that are necessary; one condenser knob with perhaps a little gearing, will take care of all the tuning. In other words, a single control outfit, without rheostat, without variocoupler, without variometer, with nothing but a single knob. Such outfits are already on the market today and are welcomed by the public for the reason that one has to be an expert or know something about radio to operate many present day outfits. Your mother, sister, or daughter cannot operate such receivers, and must wait until you come home. Years ago, it took an expert mechanic to drive an auto. It takes an expert today to handle the average radio outfit. Five years hence radio outfits will be simplified to such an extent that everybody can use them, just as anyone can drive a car now.

Then there is our great American nuisance, the loud-talker. To be correct it talks loudly but says nothing. We are still awaiting the loud speaker without a horn. Why the horn was ever thought of is just another of the unsolved radio mysteries. When a human being speaks, he uses no horn. The cricket makes a sound that can be heard for half a mile, the sound coming from a surface less than 1" square; and again there is no horn! The traffic policeman when sounding his whistle does not require a horn in order to project the sound. When the nightingale sings, it may be heard more than a mile away; evidently it can worry along very nicely without a horn.

One of these days someone will sit down and read all the books on acoustics that have ever been printed and after that he will do some thinking of his own and the result will be a loud speaker that speaks loudly and which is smaller than your fist.

That loud speaker, by the way, will be built into the future radio receiving outfit, and why shouldn't it be? The loud speaker today is conceded to be the most important part of a radio outfit. You might as well take the engine of your auto and mount it on a separate truck and lug it around. This would be a good analogy and is just what we are doing in radio today.

Multiple Broadcasting

HOW A CONCERT IS BROADCAST BY STATIONS IN DIFFERENT CITIES SIMULTANEOUSLY.

By S. R. WINTERS

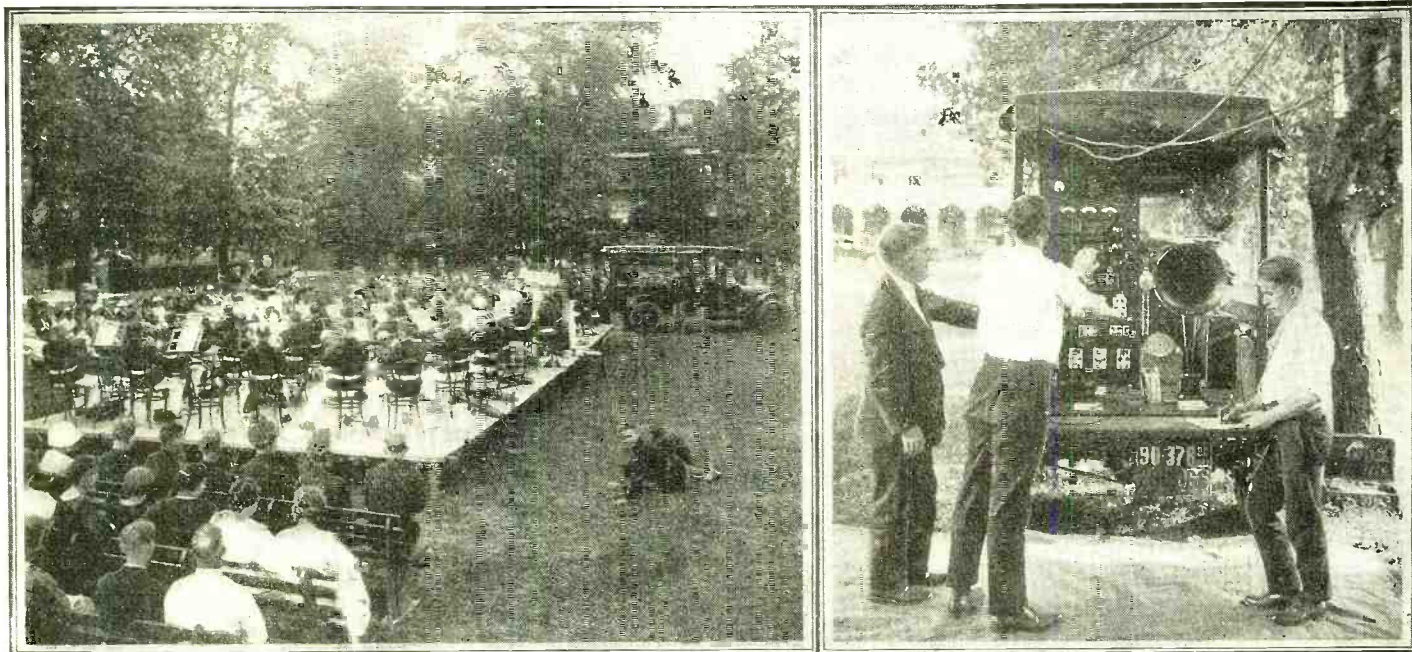

Above: By Means of a Portable Speech Amplifier Mounted in an Auto Truck, the Entire Program of the Marine Band at Washington, D. C., Was Transmitted Over the Telephone Lines to Three Broadcasting Stations Which Transmitted the Music Into the Ether Simultaneously, But on Different Wave-lengths. Right: Interior of Station WCAP, Washington, D. C., Which Operates in Unison with WEAJ at New York and WMAJ at Round Hill, Mass., and Other Stations.

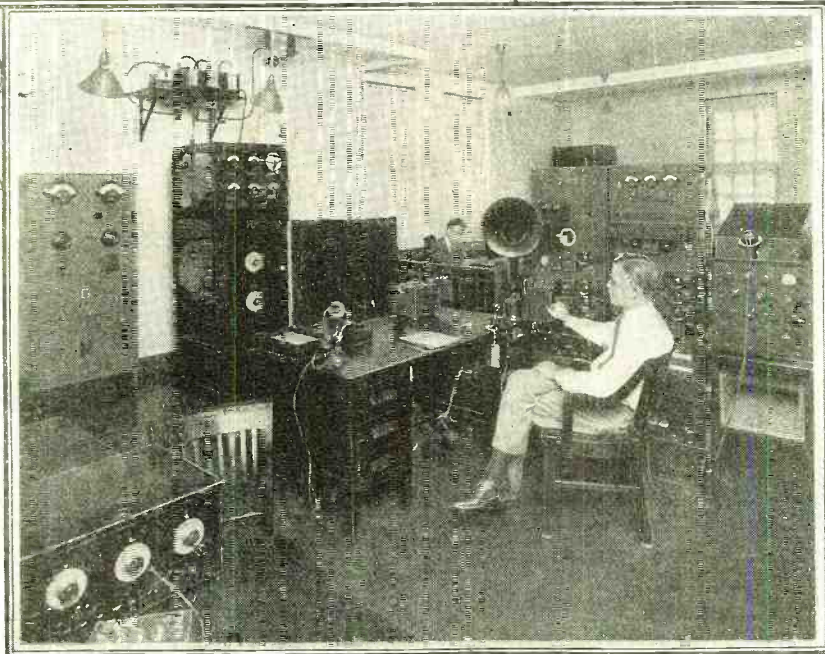

Above: The Portable Speech Amplifier Used for Transmitting the Speech and Music Over the Telephone Lines to the Broadcasting Stations from Where it is Transmitted into the Ether. The Loud-speaker Seen on the Rear of the Auto Truck Replaces the Usual Microphone That is Employed for Picking Up the Sound Waves.

IN Biblical times it is related of Mohammed that he went to the mountains when they could not go to him. A modern version of this parable is the accomplishment of the Chesapeake and Potomac Telephone Company, in the National Capital, in going to the event with radio broadcasting apparatus when the exercises cannot be held at its broadcasting station.

A motor truck, completely equipped with radio instruments for picking up musical programs or speeches, has been recently placed in operation by the local telephone company. The microphone, resembling a loud-speaking horn, shown in the photograph, and input or amplifying electrical circuit mounted on this motor-driven vehicle enables WCAP, radio broadcasting station of the Chesapeake and Potomac Telephone Company, to relay a musical program of instrumental or vocal exercises from any point in the District of Columbia to its

broadcasting station for dispersion in the usual way.

For instance, the musical programs of the Marine Band and the United States Navy Band have been picked up at the Marine Barracks or at other points and conveyed along a conducting telephone wire to the broadcasting station of WCAP, located on the top floor of a 12-story building at 735 Thirteenth Street, Northwest. The wire for conveying out-of-door programs to the broadcasting station may be temporarily or permanently installed, and in addition to the conducting line there is a second or auxiliary wire by which the operator of the portable wireless outfit and the operator at the broadcasting station proper may carry on conversations to determine the relative clarity of the programs that are being relayed.

This "radio broadcasting station on wheels," or "pick-up truck," the latter designation being given by the local telephone

company, only recently picked up the entire musical program of an orchestra at a local theatre and it was broadcast while the performance was in progress. The radio-equipped motor truck was "parked" in the alley of the theatre and the microphone, with its big horn resembling a loud-speaking device, harnessed the musical strains, enabling them to be conducted along a conventional telephone wire to the regular broadcasting station.

As this article is being written, arrangements are being made for relaying the services of a local church in a similar manner. Doubtless other events conducted in the out-of-doors, in theatres or in auditoriums will be picked up in this fashion—in a word, the studio of the broadcasting station will be taken to the event instead of the latter being brought to the regular broadcasting station. In this particular WCAP occupies a singular distinction among the
(Continued on page 812)

Radio Vision

By H. GERNSBACK

Member American Physical Society

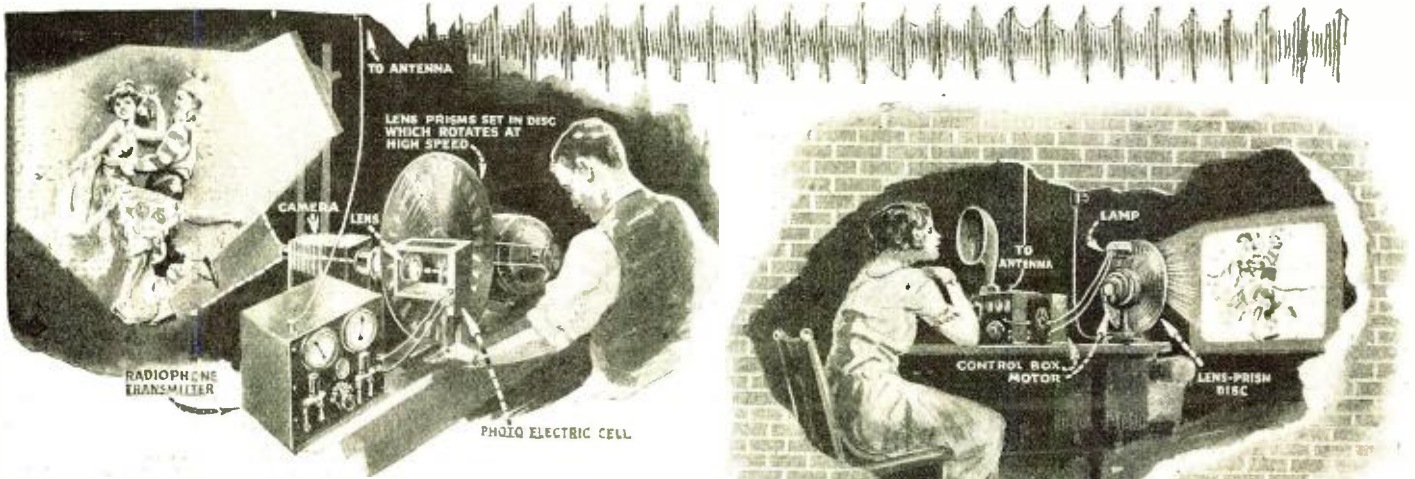

This Illustrates the Jenkins' Method of Sending Moving Pictures by Radio. The Main Instrument in the Machine is a Disc Revolving at High Speed, Upon Which Are Mounted Special Lens Prisms. A similar Disc is Used in the Receiver Which is Comparatively Simple and May Be Operated from an Ordinary Radio Receiver and Amplifier.

I HAVE just left the laboratory of Mr. C. Francis Jenkins of Washington, D. C., and am still under the influence of what I consider to be the most marvelous invention of the age. I have seen an actual demonstration of seeing, not only around corners through thin wires, but through space as well. The demonstration—a private one—took place before a General of the Army, his staff, and myself.

Mr. Jenkins, the well known inventor, has worked for many years on this invention. Mr. Jenkins, by the way, is the original inventor of the motion picture projecting machine; his old experimental apparatus is now in the United States National Museum, for which invention he was awarded the Elliot Cresson gold medal, by the Franklin Institute. Although the machine, the demonstration of which I have witnessed, is not as yet entirely perfected, I had been able to see my hand projected by radio and being received by radio. In one of the illustrations, you will observe several small objects in the foreground of the transmitter, such as a key, cross, clamp, etc. By placing these in the path of the light, the picture was transmitted by radio and was received again at the other side by a radio receiving apparatus. It was possible to wave these small

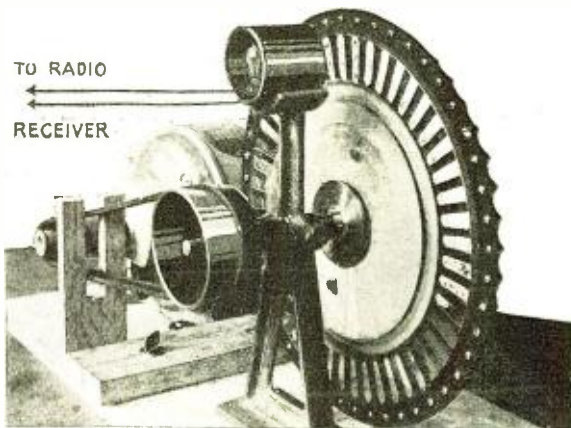

Above is a Back View of the Receiving Apparatus Which Projects on a Screen Pictures of Moving Objects Displaced Between the Lens and the Bellows of the Transmitter Shown Below. Note the Small Crosses of Metal and Keys Which Are Used in the Experiments.

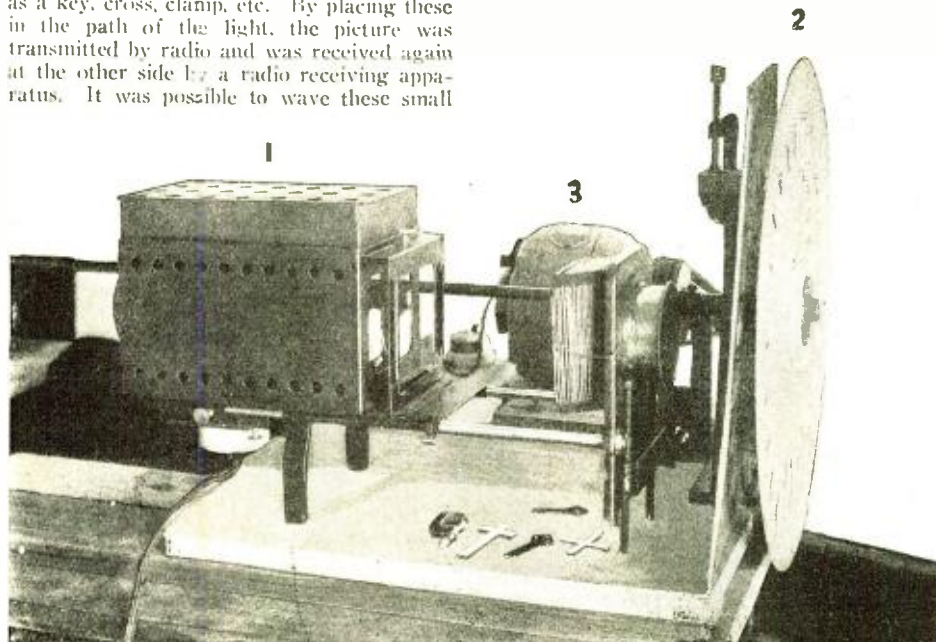

objects in the path of the light ray of the transmitter and one could amuse oneself by seeing how these objects were actually being transmitted by radio.

While of course the apparatus used by Mr. Jenkins today may appear cumbersome and complicated, it should be remembered that the first telephone and the first radio outfit were no less complicated, and perhaps more so. It is not necessary to go into the technicalities, as we have in past issues of RADIO NEWS described some of the important parts of Mr. Jenkins' invention. The former articles, however, dealt exclusively with the transmission of pictures by radio and it is easily understood that there is a vast difference between transmitting a photograph and transmitting a baseball game while it is being played. The underlying principle of the two machines, however, is practically the same. Roughly, Mr. Jenkins, by means of revolving prisms, cuts up the light rays which vary the resistance of a light sensitive cell, such as, for instance, the well known Case Thalofide cell. The fluctuating currents after passing this cell are fed to a regular vacuum tube sending outfit where the variations of the light impressions affect the modulation of a lamp, as the voice does. Radio waves are then sent out into space and are received on a regulation radio outfit. The receiving apparatus is very simple. One of the illustrations shows the receiver. It consists of only three parts, namely: A revolving disk with prism and lenses, a motor and a special lamp. The special lamp is used in place of a telephone receiver or loud speaker and this is what happens: The waves as they come in light and extinguish the small pin lamp thousands of times per second. Looking at the lamp with your eyes, you would think it was fully lit. This is, however, not the case. The lighting and extinguishing take place so rapidly that one cannot follow them with the eye. After the light ray passes through the revolving prism lenses, the picture is auto-

(Continued on page 823)

The Radio Chauffeur Call

By DR. LEE De FOREST, Ph. D.

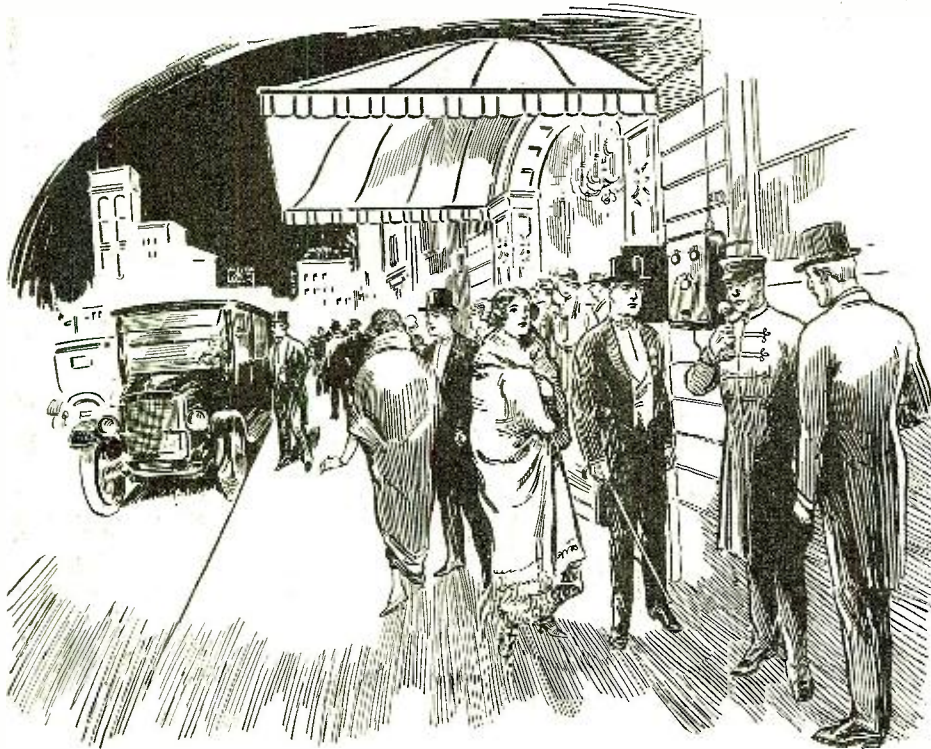

If Private Automobiles and Taxis Were Equipped With Radio Receivers it Would Be Possible to Call Them to the Doors of Theatres or Other Places by Means of a Low Power Radiophone. This Would Help Relieve Traffic Congestion.

THE editor of RADIO NEWS asks me to tell his readers about my idea of bringing all automobile chauffeurs within the lines of radio communication.

I am glad to do it, though to be honest with Mr. Gernsback. I would have been more pleased had the request come from the editor of an automobile publication instead of a radio journal!

It is a curious condition, but the fact is that this idea holds out much more benefit for automobile manufacturers and car owners than it does for persons whose principal concern is with radio. And yet, our radio friends are the ones who get the idea right away and we have to go pounding away to awaken any interest on the automobile side of the fence.

The idea of communication between broadcasting stations and motor cars occurred to me a long time ago. It is so simple and so feasible that I never dreamed it would be difficult to put it across; but the fact is I have had difficulty in getting a reaction of any great interest from motor car manufacturers. On that account and because of other demands on my time the idea has been more or less neglected.

Just the same, it will come to pass, because it is a logical development.

The equipment, as I have planned it, is simplicity itself.

Inasmuch as no owner of a fine limousine would want to go riding around with an aerial sticking out on top of his car, the plan calls for a horizontal loop built into the top of the car, with a little receiving set and a loud speaker inside the car.

Thus the motorist will be equipped to tune in and listen to any broadcast station wherever he happens to be or while en route.

Surely nothing could be simpler. The cost of so equipping a limousine will be com-

paratively slight and it will most certainly add a wonderful selling point.

To get entertainment on the highroad or

IN this article, especially written for RADIO NEWS, Dr. DeForest explains a novel use for radio, a patent for which he has applied. The scheme is quite practical and will, no doubt, be in general use before many years have passed. It consists of a device for calling the drivers of taxis and private cars, equipped with small radio receivers, to the point where they are needed, a low power transmitter being used for this purpose. Such apparatus could be used at the doors of theatres, department stores or other public places where patrons need cars, and so save them the trouble and delay of hunting for their conveyances.

in the by-ways—there is a theme for a motor car salesman! I must confess, though,

This Sketch Illustrates Diagrammatically How a Small Radio Receiver With Loud Speaker Might Be Installed in an Automobile for the Purpose of Calling the Driver from Any Point to Where the Car is Needed, as Explained in the Article.

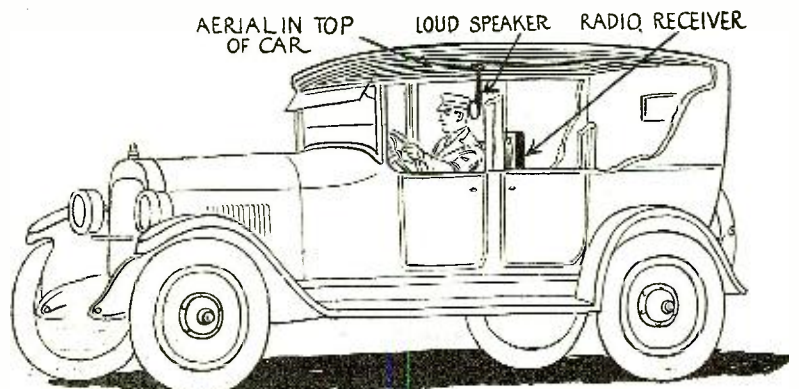

that when I first thought of communicating with automobile via radio, it was not the entertainment feature which appealed to me. In truth, I then did not even think of it.

It happens that I am a great lover of music and Mrs. DeForest and I are frequent patrons of the opera. I do not know if everyone has as bad luck after the opera as I have, but it seems that invariably my car is among the last of the long line to draw up after the opera is over. Although a number may be among the first to be called and flashed on the electric call-board, the chauffeur is usually around the corner where he cannot see the sign.

This continual petty irritation after a glorious evening of music started me on a train of thought for a solution. Naturally, I viewed the problem through the eyes of a radio enthusiast and the solution which presented itself was the one I have outlined: to call the chauffeur by radio.

If my car were equipped with a receiving set and if the opera house—or every theatre for that matter—had a small power, short-wave-length radiophone transmitter near its side doors, the door-man would merely need to call my number into the microphone by the door and my chauffeur would get it, no matter where the car was parked, whether within view of the electric call-board or several blocks away.

The transmitter would only need to be strong enough to insure a range of about one mile and the expense therefore would be slight. It certainly would not be great in consideration of the service it would give patrons. The wave-lengths from such a broadcasting station could either be much shorter or much longer than those reserved for ordinary broadcasting.

As I said, the idea occurred to me because I was such a consistent patron of the Metropolitan Opera House in New York, but its field could be much wider than that. The same idea could be extended to all theatres, to all department stores, to all clubs and institutions and all such commercial and non-commercial organizations as serve people who drive limousine cars.

As I dictate this article, it occurs to me that the idea opens up an interesting market for manufacturers of radio equipment, as well as adding value to the product of automobile manufacturers.

The call to chauffeurs, especially as it relates to patrons of places of amusement, appeals to me principally in any discussion of radio communication to automobiles. The amusement or rather the entertainment angle is by no means to be lost sight of, however. To be able to maintain contact

(Continued on page 822)

The Clariphone, A New Static Eliminator

By S. R. WINTERS

OUTWARDLY, bearing a striking resemblance to an eight-cylinder aircraft motor, an apparatus designed to eliminate atmospheric disturbances common to the reception of radio communications, is the fruition of 11 years of ceaseless effort exerted by William J. Scott, of the United States Navy Department. The results of his ingenuity are represented by the assembling of 10,240 bits of mechanism into one instrument taking the descriptive term "Clariphone." As the name implies, this device aims to clarify sound, by selective action, divorcing the abrupt and discontinuous noises from the orderly and uniform sound. Thus, in the case of the reception of wireless signals, "static" is virtually eliminated and the intensity of atmospheric disturbances is not a bane to radio communication.

If the results of preliminary tests in the adaptation of the "Clariphone" to the reception of wireless signals is a reliable criterion upon which to base an appraisal, this instrument pledges greater assurance in the minimizing or eliminating of "static" or atmospheric disturbances than any of the so-called "static eliminators" yet given practical application. Even this apparently extravagant claim is employed by the writer advisedly, in view of the difficulty attending the elimination of disturbances common to wireless signaling and the proneness of the public to discount the appearance of new devices bearing the labels of "static eliminators." The inventor of the "Clariphone," however, has displayed remarkable ingenuity, and in support of this conclusion it is pertinent to quote the authoritative opinion of an examiner of the Patent Office of the United States Treasury Department, who goes on record as saying:

"It is recognized that the applicant has apparently a pioneer invention in this field. The device evidently accomplishes the result desired, as shown in the demonstration at the Bureau of Standards. Just why the device works as it does is not known. This can only be theorized upon." Applications for patents are on file in the United States, England, France, Germany, Sweden, Norway, Italy, Japan and Argentine. Papers offering protective rights to priority of discovery have already been granted by the constituted

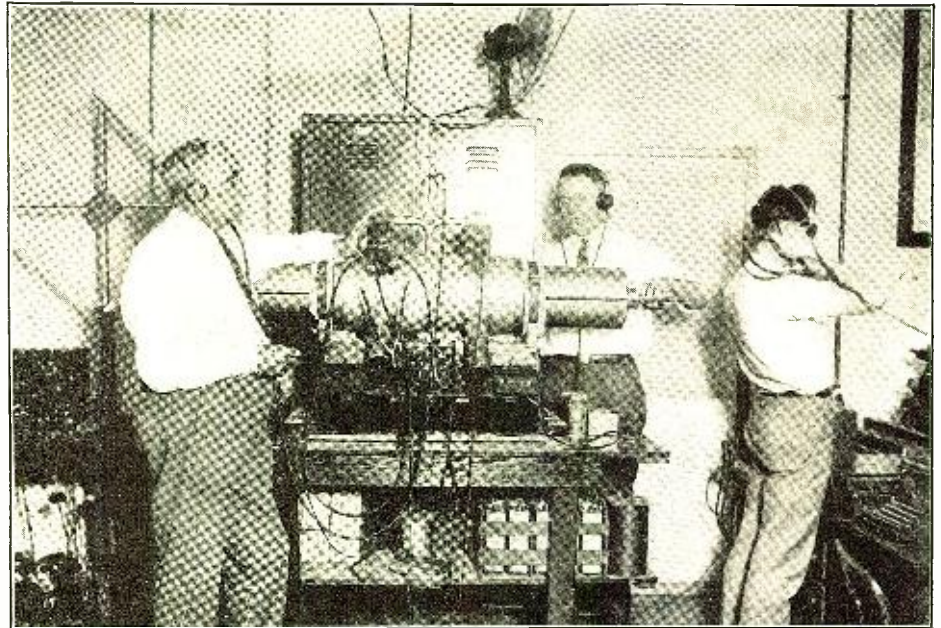

W. J. Scott, the Inventor of the Clariphone, is Shown in This Picture Standing in Front of His Apparatus.

authorities in Canada and Brazil. The inventor, taking his source of inspiration from the tropics where atmospheric disturbances seriously interfere with radio communication for weeks successively, conceived the invention while on duty on Culebra, a part of the United States Naval base, 11 years ago.

PRINCIPLES OF THE INSTRUMENT

This instrument is built on the principle of acoustics, capable of exercising selective action in eliminating or subduing mechanical sounds or voices of an abrupt or discontinuous character and sustaining for delivery, musical and continuous or uniformly pitched sounds, such as those of the human voice, musical instruments, or radio telephone and telegraph messages. Its structural features adhere to the principle of the filtering or clarifying of sound. The apparatus, in reality, is cylindrical in shape, with eight telescope tubes protruding from the cylinder, through which the wireless signals or other sounds are conveyed to the interior of the

mechanism. The transmission of sound to the inside of the device is accomplished by providing each of the eight telescope tubes with a conventional telephone receiver, the latter being connected through an amplifying circuit to the radio telegraph or telephone receiving apparatus. As the incoming wireless signals are "tuned in" on the receiving set, the radio operator may, on account of the severity of "static" or atmospheric disturbances, be unable to copy the signals. He may, however, be able to detect the call letters identifying the wireless transmitting station, in which case he throws an electrical switch, which in turn, puts into operation the "Clariphone" circuit. The incoming radio signals are now transferred to the input telephone circuits of the telescopes of this interference-discarding device where the signals are subjected to various weeding out channels—clarifying process, if you will. There the dots and dashes—in the case of the Morse International code—are passed onto a set of microphones, installed on either end of the air chamber of the "Clariphone." Once the latter is tuned acoustically until the maximum strength of the wireless signals and minimum strength of atmospheric disturbances are obtained the signals are made electrical again, a practice common in any conventional telephone wherein a microphone and receiver are employed. In addition to this, the received wireless signals are carried along to a channel to which is attached an outlet tube, this arrangement permitting of a reception of the communication through a tube attached to a shell of a telephone headset. That is to say, the radio signals are received electrically and not acoustically in this instance.

TESTS HAVE PROVEN SUCCESSFUL

The "Clariphone" has been adapted to experimental use by the Radio Central Control Station of the United States Navy Department, the results of these tests further confirming the promising theoretical possibilities of the invention. Radio signals have been copied without difficulty when wireless-telegraph stations in Lyons, France; Balboa, Panama Canal Zone; and San Diego, California, were transmitting wireless communications, despite the intensity of "static" or atmospheric disturbances. The outstanding

(Continued on page 752)

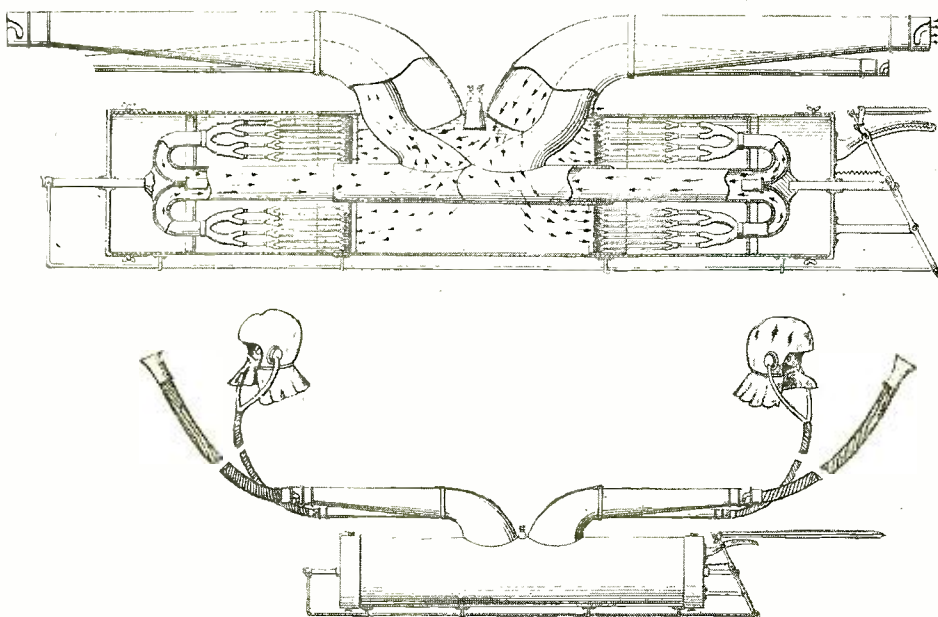

The Interior of the Clariphone, Showing the Various Acoustic Chambers in Which Static is Virtually Killed. The Lower Drawing Shows Where the "Input" Tubes and Headphones Are Connected.

The Radio Controlled Aeroplane

By MAURICE PERCHERON

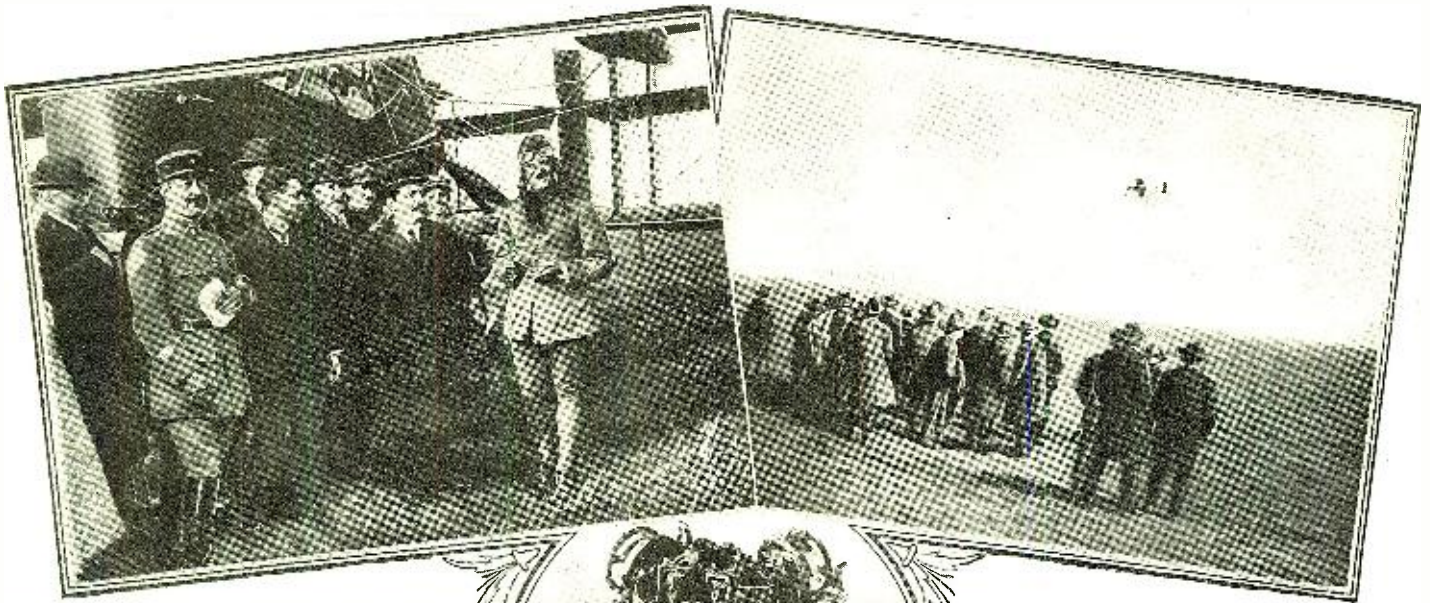

Above Are the Men Responsible for the Development and Practical Realization of the Radio Controlled Aeroplane. From Left to Right in the Front Row Are Captain Max Boucher, Maurice Percheron, de Marcay, Laurent Eynac and Captain Arbanire.

The Automatic Radio Controlled Aeroplane in Flight in a Demonstration Given Before a Group of Scientists and Newspaper Reporters. On the Left is Shown the Very Heart of the Aeroplane, the Group of Gyroscopes Which Keeps it in the Proper Position at all Instants While in the Air.

THE control of mechanisms by radio is as old as radio itself, for Professor Branly, inventor of the Coherer, designed a simple demonstration set to show that it was possible to perform operations at a distance by means of apparatus operated by electromagnetic waves. With this apparatus he was able to light a lamp, start a small electric motor and control other instruments, using as the transmitter a spark coil and as a receiving system his Coherer connected to a relay which itself closed the various local circuits through a distributor operated by clock-work. Since then various radio controlled systems have been designed and the readers of RADIO NEWS know of several radio controlled cars and ships, which have been described in past issues. However, no data has ever been given on the radio control of aeroplanes and it is the purpose of this article to describe the experiments and, we may say, achievements of the Research Department of the French Signal Corps.

In 1918 the engineers of the French Signal Corps, under the direction of General Ferrié, began to work on an aeroplane which would be used for military purposes, and controlled by radio, to take photographs, and to carry over the enemy lines explosives to be dropped at the proper instant, thus saving many a pilot the risk of the venture. The engineers in charge of the development were Capt. Max Boucher, assisted by Messrs. Gueritot, Manescau and Brillouin. Experiments were carried on over a period of several months by these engineers who succeeded, on Sept. 14, 1918, in sending up a radio controlled aeroplane which flew over the Aerodrome of Chicheny for 51 minutes, executing various complicated maneuvers and covering about 80 miles. At the time of the Armistice, these experiments were stopped and for almost three years no further work was done by these engineers, who were demobilized.

DEVELOPMENT IN FOREIGN COUNTRIES

During this time other experiments for the radio control of ships proved the value of

apparatus such as that invented by Messrs. Dolme-Dehan and Abraham. The Committee of Researches and Inventions experimented, on the Seine near Paris, with a radio controlled motor boat developed by Mr. Chauveau. In England and the United

IN this exclusive article which Mr. Percheron wrote especially for RADIO NEWS, is described for the first time, the automatic Radio Controlled Aeroplane developed by the Radio Section of the French Army Signal Corps, and the Société Française de Télémechanique. It is an epoch making achievement in both the Radio and aeronautical fields and we are pleased to present to our readers the details of this unique machine which has passed severe tests and has proven entirely practical for commercial use.

States developments were pushed to such an extent that France realized the necessity of resuming the experiments which proved so successful during the war. In 1921, Mr. Laurent-Eynac, then Under-Secretary of State Aeronautics, asked Mr. Max Boucher and the author to further develop the radio controlled aircraft for peace-time use. During the war many problems had been set aside, for it was necessary to work fast, and no time could be spared to study in detail minor problems. These engineers, therefore, decided to take the problems at the beginning and proceed, solving every detail as the work progressed.

The question of making an aeroplane entirely automatic, and to replace the skill of the pilots by mechanical devices is one of the most difficult to solve. If the piloting of an aeroplane may be learned in a few days, the necessary skill is only acquired after many flights and it is the profession which probably calls most for the sporting qualities of an individual. The innumerable factors which must be contended with by the reflex actions of the pilot necessitate the use of such mechanisms presenting extreme flexibilities in order to compare with the human control of an aeroplane which meets with so many varying conditions while in flight. The first big problem to be solved was that of the automatic stabilization of the craft. Since the beginning of aviation, many a device has been proposed to diminish the risks of human control. Among these may be mentioned the aerodynamic rudder of Mr. Dautre, the Sperry gyroscopic stabilizer, the Aveline mercury stabilizer, etc., but none of them gave all the desired results, and for this reason were abandoned.

AUTOMATIC STABILIZATION

The problem, in fact, is very complex, for an aeroplane in flight tends to take three different rotary motions around three rectangular axes and three motions of translation along these axes. It is necessary, when the aeroplane has to fly along a given line, to allow five or six degrees of possible variation. For this reason it would be necessary to install five different stabilizers on account of the difficulty which is found in designing mechanisms having more than one degree of variation. However, it was found possible to limit to three the number of necessary stabilizers. As stated above, an aeroplane properly balanced tends, as a boat, to come back to its position of equilibrium if it does not list too far on either side, and thanks to this property, it was found possible to absolutely control and compensate for the variations encountered in flight. To obtain the absolute control of the aircraft, the stabilizers must be able to operate some compensating forces capable of bringing it

back into the correct position and stop these forces before it has reached it in order to prevent an undesirable oscillating motion. Six organs must, in principle, constitute a stabilizer for automatic aeroplanes: First, a fixed point connected to the aeroplane itself; second, another point fixed to a given unvariable plane, which may be at a given angle, so as to stabilize the plane in relation to air currents; third, several controlled motors acting upon the various organs of control; fourth, an inertia compensator preventing the reactions of the fixed point which must be unvariable. It is well known that a pendulum, moved in the space, for instance, may be subject to acceleration when changing its period and not indicate the vertical line. This is why its use, as well as that of similar devices, is prohibited on board an aeroplane. Fifth, a controlling organ connecting the fixed point to the movable one so that the action of stabilization may stop before the normal position is again reached. Sixth, a stopping device to prevent the reaction of the air upon the controlling organ to impress the controlling apparatus.

Of course, these six controls must function perfectly and independently, no matter how great the disturbances impressed upon the aeroplane. This gives an idea of how complicated the first condition of automatic control is, for in practice every one of the organs must be carefully adjusted, and this requires a great amount of work.

GYROSCOPIC STABILIZERS ARE USED

The type of automatic stabilizer used in the experiments was the Sperry gyroscope which had to be modified to fit it for this particular purpose. The type of gyroscope used consists of a disc of small weight but turning at a very high speed (15,000 to 18,000 R.P.M.); it has considerable inertia and among other properties tends to remain always in its rotating plane. Another property of the gyroscope, this one detrimental, is the tendency which it has to move perpendicularly to its plane of rotation when it is displaced from it. Thus, the gyroscopic effect must be compensated for by another gyroscope rotating in the opposite direction and playing the role of the fourth organ mentioned above, the inertia compensator. The aeroplane is equipped with two gyro-

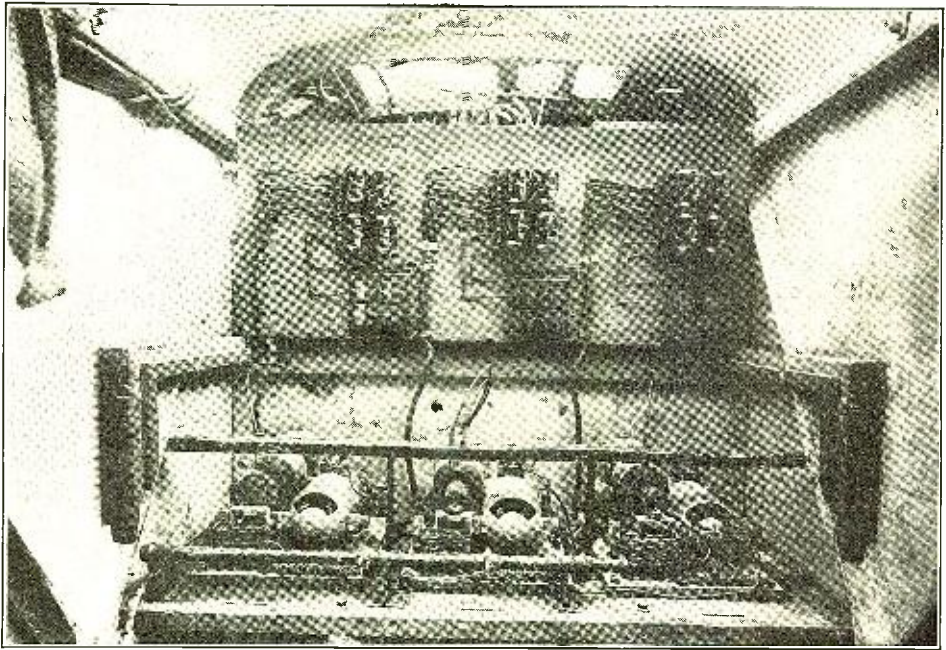

The Electric Motors Operating the Various Organs of the Plane. Note on the Board the Controlling Relays Connected to the Radio Receiver Installed on the Aeroplane.

scopes coupled together and rotating in opposite directions to control the upward and downward flights, another one for the lateral equilibrium and a third to control the direction. These systems of gyroscopes are equipped with a fixed sector upon which a brush contact is made and moves when the aeroplane is unbalanced in one plane or the other. These establish electric contacts which by means of electric motors, control the action of the rudder and wings.

The flexibility of this type of control is such that the aeroplane thus controlled may fly in strong winds and always come back to the normal position when it is deviated from one plane or the other. In order to start the aeroplane from the ground and control its flight, it is necessary to suppress the action of the automatic stabilizers. It is at this point that radio control is employed to change the ratio of the gears controlling the various stabilizers; this is accomplished by a mechanism somewhat similar to the

transmission of an automobile. For quick action, the movement of the brushes sliding upon the sectors may be stopped and the former kept in a fixed position so as to make the aeroplane go up or down, or turn quickly, the speed being regulated by the transmission arrangement mentioned above. All these controls are assembled on a panel and are operated by a series of relays connected to the radio receiver. Once a control has been set in a certain position, it remains so until it is opened by radio signals, thus if the aeroplane is put in such a position, so as to fly around, it will do so until the proper control is operated to change its course.

AEROPLANE ENTIRELY AUTOMATIC

The experiments carried out at the aerodrome of Etampes by the Soci t  de T l m canique are a great achievement in aeronautics, for the automatic flying will increase the security of the pilots and an application of this system which the big commercial aeroplane transportation companies will adopt, will permit the pilots to be real captains of airships. All the apparatus described previously are susceptible to control the largest sizes of aircraft, thus the pilot, not having to worry about the control of the aeroplane, will be able to keep in touch with the ground and other aircrafts by means of radio and to closely follow his route by checking its position on the map. This system will also permit the use of pilotless aeroplanes for the transportation of cargo and for meteorological observations at high altitudes, in this case recording apparatus equipped with electric contacts would control various mechanisms which it is necessary to operate when reaching high altitudes. This control might also be operated by means of clocks since the speed of the aeroplane is known and also the angle at which it goes up. These methods of control are only practical within a short radius, or for a limited number of operations; as soon as the aeroplane has to fly over great distances and through a great many varying conditions, the controls must be more flexible and radio is then employed to operate, on board, the controlling devices.

If it were possible to connect the aeroplane with a controlling station by means of

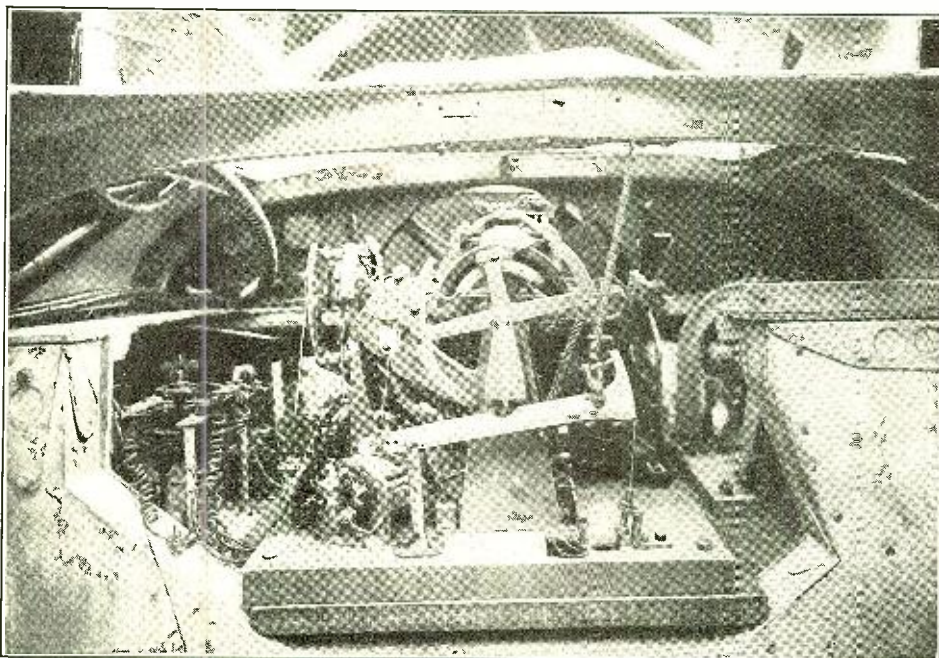

This Gyroscopic Stabilizing Apparatus Takes the Place of a Pilot and Automatically Keeps the Plane in the Proper Position While in Flight, in Spite of Strong Winds.

(Continued on page 822)

A New and Ultra-Sensitive Detector, the Sodian

By JOHN V. L. HOGAN*

CONSULTING ENGINEER; PAST PRESIDENT AND FELLOW, INSTITUTE OF RADIO ENGINEERS; MEMBER, AMERICAN INSTITUTE OF ELECTRICAL ENGINEERS.

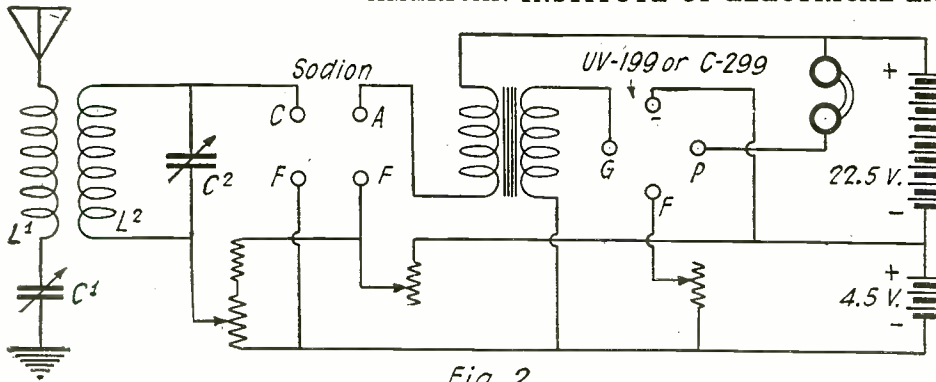

Fig. 2

Circuit of the Sodian Detector with One Stage of Audio Frequency Amplification.

THE novel detector tube that was described by its inventor, Mr. Harold P. Donle, at a recent Institute of Radio Engineers' meeting, offers almost endless possibilities of investigation and experiment. Its extreme sensitiveness, which has been measured by a number of independent laboratories and found to be about two stages better than that of the standard hard audion tubes, makes the Sodian particularly interesting to radio amateurs and broadcast listeners who are anxious to increase their ranges of long-distance reception.

Unlike the audion tubes that we have come to know so well, the Sodian contains no grid or interposed control-electrode. It gets its name because it utilizes some unusual properties of ionization of an alkali or highly electropositive metal such as sodium, the new word being derived from "sodium" and "ion." The input circuit of the Sodian detector is connected between its filament and an electrode called the collector, which is a bent or trough-shaped plate that partially surrounds the filament and has its open side toward the anode. The output circuit extends from this anode to the filament, and contains a "B" battery and the usual head-telephones or the primary of an audio-frequency amplifier transformer.

Fig. 1 shows the Sodian tube in diagrammatic form, with a standard circuit that gives good results. The small heater that is shown above the tube in this drawing is in the practical bulb wrapped around the glass tube and covered, for protection and heat-retention, by a second glass shell which makes the tube very easy to handle.

In setting up the circuit of Fig. 1 with the type S-13 or dry-cell Sodian, an "A" battery of three fresh dry cells in series should be used. These will operate the tube for a long time, since the current of the filament circuit is only 0.24 ampere or a little less than is called for by the WD-11 and WD-12 dry cell tubes. The working voltage is 3.8, however, and when the three dry cells have dropped from their "new" voltage of 4.5 to this value, they should be replaced or reinforced to maintain the desired e.m.f. A set of three standard No. 6 cells will last for three months or more, however, under average use of one hour per night. A standard filament rheostat of 3 to 6 ohms will be found adequate to take care of the excess potential of three fresh dry cells, though if it is desired to use a 6-volt storage

battery a 10 or 15 ohm rheostat will be necessary to reduce the current sufficiently.

The Sodian tube is not critical as to anode potential, but best results will ordinarily be had by using a single 22½-volt "B" battery block. In the input circuit, note that a direct connection is made from the filament through the potentiometer and the tuning inductance to the collector electrode, with

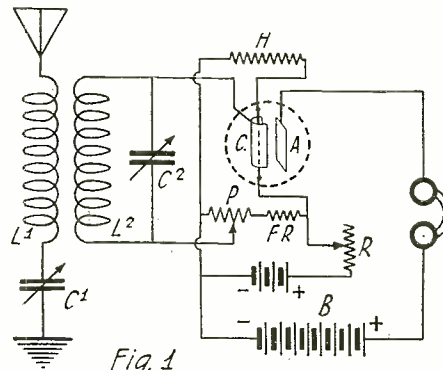

Fig. 1

Hook-up of the Sodian Detector. It is Necessary to Use a Double Circuit Tuner with Very Loose Coupling, as the Resistance of the Collector Circuit Should Be Low.

no blocking condenser or leak resistance of any kind. Care in the choice of low-loss coils and condensers for the primary and secondary circuits will be repaid in increased selectivity and signal strength.

The potentiometer should be of about 50

ohms resistance and should have in series with it (on the positive side) a fixed resistor of from 100 to 150 ohms. This will give ample range of adjustment on the potentiometer scale, yet will not introduce large resistance into the radio-frequency circuit to the negative end of the filament. An ordinary 30-ohm rheostat having three connections may be used for the potentiometer, but then the series resistor should not be of more than 75 or 100 ohms resistance.

Having set up the circuit as described, of course the next thing to be considered is its operation. The tuning of two-circuit receivers has been explained in print many times, and the only peculiarity notable when the Sodian tube is used is the extremely weak coupling that may be utilized without marked loss of signal strength. The detector is so sensitive that the ordinary variocouplers are unsuitable for use with it in the circuit of Fig. 1, because electrostatic coupling between primary and secondary is too great to allow good selectivity even when the magnetic coupling is reduced to zero. Some form of coupler in which the two coils are moved physically apart as the coupling is weakened should be relied upon for best results.

With the weak couplings that the Sodian's high sensitiveness makes feasible, the two circuit tuner is very selective. This makes it extremely important to adjust both the primary and secondary tuning condensers very carefully whenever one changes the coupling or shifts to a different wave frequency.

The detector is simplicity itself to operate. Turning on the "A" battery, bring the filament current up until the tube glows at a bright yellow color (not a brilliant white); then adjust the potentiometer to give the loudest signals. If the filament current is too high, a hiss will be heard in the telephones at all settings of the potentiometer. On the other hand, if the current is too low it will not be possible to get a hiss at any position of the potentiometer. For correct filament current a slight hiss will be heard at one or two points of the potentiometer scale; the most sensitive adjustment is usually just below such a hissing point. In general the faint hiss will be heard only when the receiver is detuned or when no waves are being received; the application of a radio frequency carrier current to the detector

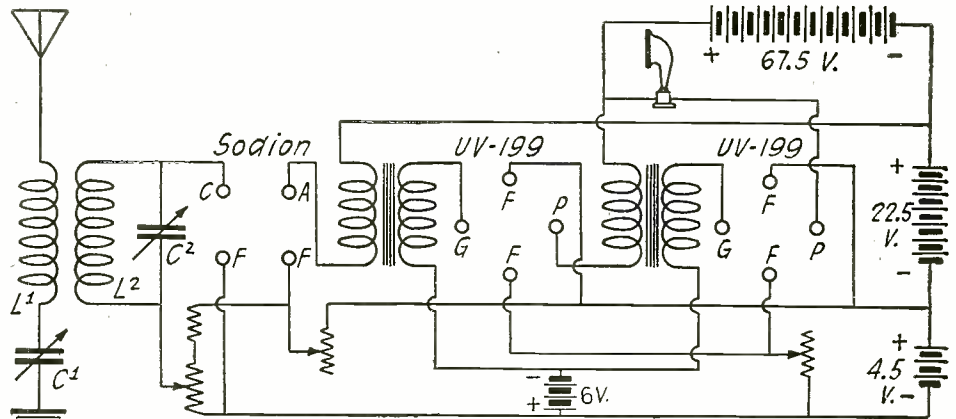

Fig. 3

With a Loud Speaker, Two Stages of Audio Frequency Amplification Should Be Used After the Sodian, as Shown in This Diagram.

*Author of "The Outline of Radio."

stops the hiss, and this action is a useful aid in "picking up" unmodulated waves.

One of the most striking things that will be observed on first using the Sodian detector is the absence of squeals and whistles during tuning adjustment. The detector cannot be made to oscillate at receiving frequency, in the usual circuits, and consequently even in the hands of novice users cannot cause interference. A second point that immediately is noticed is the clarity of radio-telephonic reproduction. This high quality detection of speech and music is largely due to the "straight line" characteristics of the tube; its output power is directly proportional to the input power, from the weakest to the strongest signals.

As with any other detector, audio frequency amplifiers may be added to magnify signals not easily understandable or for loud-speaking. The voltage of the S-13 tube makes the UV-199 a good running mate as amplifier. One such amplifying tube used with the Sodian detector will usually make the signals as loud as is comfortable in head telephones, even with small receiving antennae. Two UV-199 tubes with good amplifier transformers will give loud-speaker intensity from any signal that is clear and fairly strong when heard in the telephones on detector alone.

The amplifier tubes may be run from the same dry cells as are used for the detector. Figs. 2 and 3 show the S-13 tube with one and with two UV-199 audio frequency amplifiers in the circuits recommended for those tubes. The amplifier rheostat in Fig. 2 should be of 30 ohms resistance and in Fig. 3 of 20 ohms. The "B" battery for head telephone reception with amplifier as in Fig. 2 need be only 22½ volts, though some improvement may be had by increasing it to 45 volts (two standard "B" blocks in series). For loud-speaking with two tubes it is worth-while to increase the amplifier plate potential to 90 volts (four "B" blocks) even though this makes advisable the insertion of a "C" battery of four small flashlight cells in series.

One of the most fascinating fields for experiment with the S-13 tube is its combination with radio frequency amplification. Here again the UV-199 tubes are useful as amplifiers. Fig. 4 shows a single radio frequency amplifier with the Sodian detector, in a very flexible circuit that is desirable for test work. The radio frequency transformer shown is not of the conventional type, but may easily be made by winding about 300 turns of No. 36 P.S.C. copper wire on a paper tube of 1¼" diameter for a primary and 175 turns on a thin tube that will just slide freely over the primary (about 1.5-16" diameter) for a secondary. The plate of the R.F. amplifier tube should be connected to

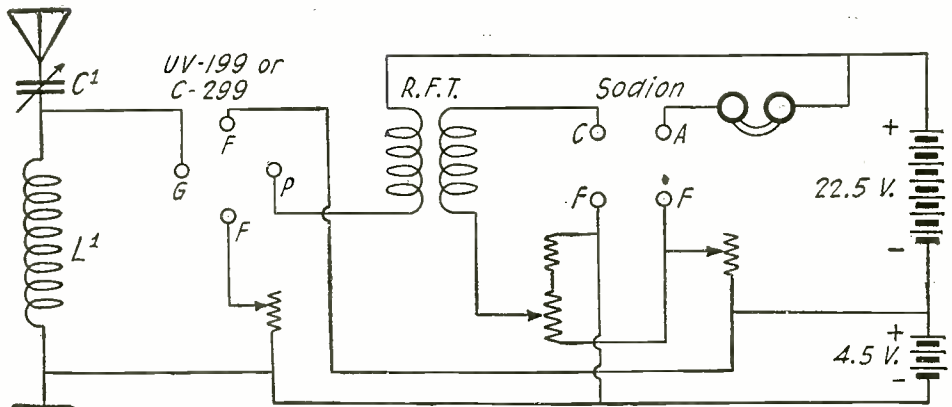

Fig. 4

The Signal Strength May Be Enormously Increased by Using One Stage of Radio Frequency Amplification Before the Sodian.

the end of the primary that is nearest the "collector" end of the secondary.

This circuit has only two adjustments, namely the tuning of the antenna circuit and the coupling of the radio frequency transformer. Care must be taken not to allow the R.F. amplifier tube to oscillate.

frequency oscillations, and it is a good plan to set up the apparatus first with the direct antenna coupling of Fig. 4. The Sodian tube will be found in itself to provide a helpful stabilizing factor in such circuits, however, and with a little care no difficulties should be encountered.

The above suggestions by no means exhaust the applications of the Sodian tube. For the scientific investigator its perhaps most interesting aspect lies in the possibility it offers of measuring weak signal intensities. A microammeter in the collector circuit will show a steady current flow of from 150 to 250 microamperes when no signals are being received. The application of a radio signal, even though comparatively weak, will cause a marked reduction of this collector-circuit current. The difference in current can easily be read on the meter, and is proportional to the audibility of the received signal. Since a signal having an audibility of only 20 or 30 produces several microamperes change in current, such an arrangement of the Sodian detector may be seen to be exceedingly useful.

Inside Construction of the New Detector Tube: C. Control Electrode; F. Filament; A. Anode; H. Non-inductive Heater; S. Glass Bulb; R. Resistance Wire Composing the Heater.

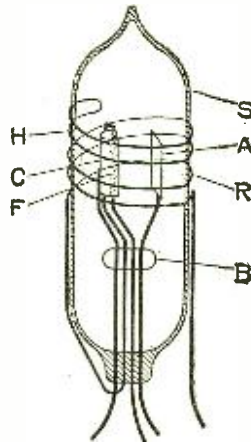

for if it does one will be likely to produce interference with nearby receivers. If the selectivity should be found insufficient to take care of particularly bad local conditions it may be improved by using an inductively coupled antenna circuit as in Figs. 1 and 5.

Another interesting possibility is the reflexing of the Fig. 4 circuit. One way of doing this is shown in Fig. 5. Here an inductively coupled antenna is indicated, for maximum selectivity. Some caution is necessary in all reflex circuits to prevent them from producing internal radio or audio fre-

BROADCASTING JAZZ FROM AN AEROPLANE

Paul Specht, New York orchestra leader, and the members of his orchestra, while abroad recently, took part in an event that is unique in the annals of radio history. Specht, in order to fill an engagement, found it necessary to travel from London to Paris in a short time. He chartered a Handley-Page bombing plane at London and embarked for Paris, with his entire band of eleven pieces on the same ship. The plane was equipped with an up-to-date Marconi broadcasting outfit, the microphone being placed directly in back of the pilot's seat inside the compartment occupied by the orchestra.

While in flight the orchestra broadcast several syncopated musical selections which were picked up by receiving sets in several of the principal English and European cities. Letters from many of those who listened in stated that the Specht concert came through with remarkable clarity, due, in a measure, to the height from which the music was broadcast, over 3,500 feet.

It was at first feared that the intense vibration of the two big motors driving the plane would interfere with the broadcasting, or that the noise would be heard above or through the music. This was found not to be the case. The traveling compartment was practically air-tight and sound-proof and acted as efficiently as the best specially constructed rooms in radio broadcasting stations.

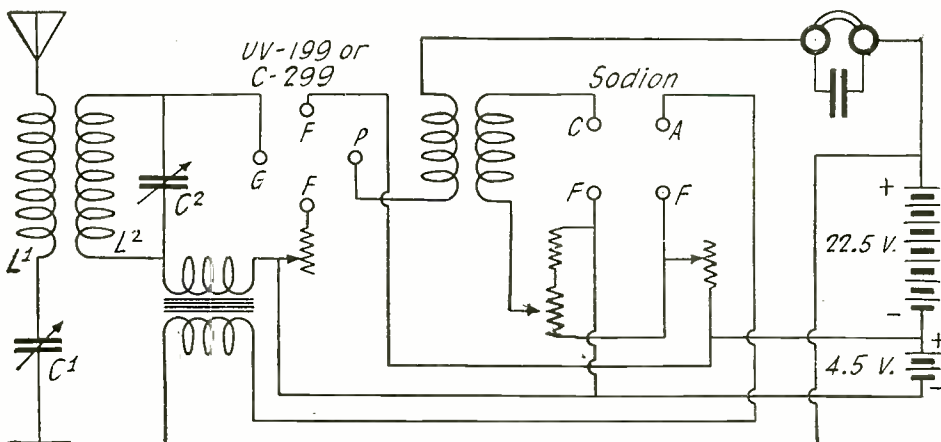

Fig. 5

A Reflex Circuit Suitable for Use with a Sodian Detector. Note That No Potentiometer Nor Bypass Condenser is Necessary for the First Tube if a UV-199 or C-299 is Used.

A New High Power Tube

By LAURENCE S. LEES

THE amateur often grumbles at the price of tubes, and he would think his grouch justified if he saw the figure against "Tubes" on the expense sheet of a big broadcasting station. A burnt out tube *can* be repaired, but the expense is disproportionate to what has been done to it, and furthermore the tube returns to you with a more or less good vacuum. It was consideration of the impracticability of the ordinary glass vacuum tube which drove M. Holweck, a French scientist working at the Radium Institute, Paris, to invent a tube which could be taken to pieces and repaired, as easily as you can take a burst tire off your car and put on a fresh wheel. His new tube has been so successful that two have been in continuous use at the Eiffel Tower, Paris, since May 23, 1923.

The difficulties to be overcome in constructing a three-electrode thermionic valve of the type imagined by M. Holweck were very complex. The filament reaches temperatures of 2,700 degrees, and it had to be borne in mind that the coefficient of expansion of the glass and the various metals used was different, otherwise serious difficulty would be encountered in keeping the interior of the valve in vacuum.

The principle upon which the Holweck valve has been constructed has been to use the plate of the valve as its foundation, that is, the red copper plate which surrounds the grid and the filament forms the cylindrical exterior of the valve. This plate is cooled by a circulating water jacket and is fitted at the top with a glass tube upon which rests a metallic cap from which the grid and the filament are suspended.

The joints of the valve at the junction of this glass tube and at all other joints are of rubber rings made of specially prepared rubber, from which all volatile matter and excess sulphur has been carefully removed. These joints, are, moreover, arranged like stuffing boxes so that only the very smallest area of the rubber rings can come into contact with the extremely rarified atmosphere of the interior of the tube.

The filament is carried by two nickel rods

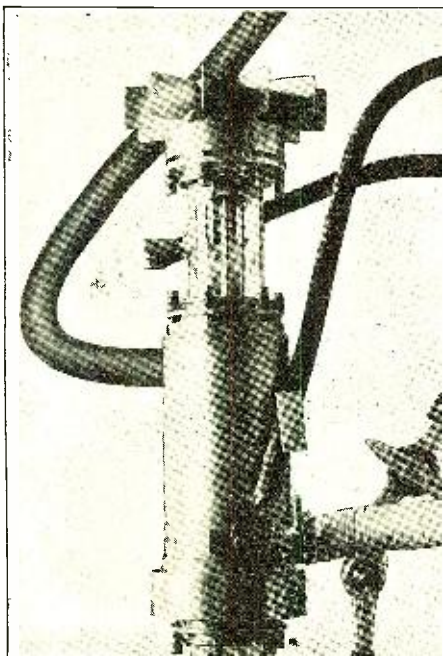

The New Power Tube Developed by Mr. Holweck. Note the Screws Holding the Rings Joining the Glass and Metallic Parts Together. This Tube, Which is Water Cooled, is Rated at 10 KW.

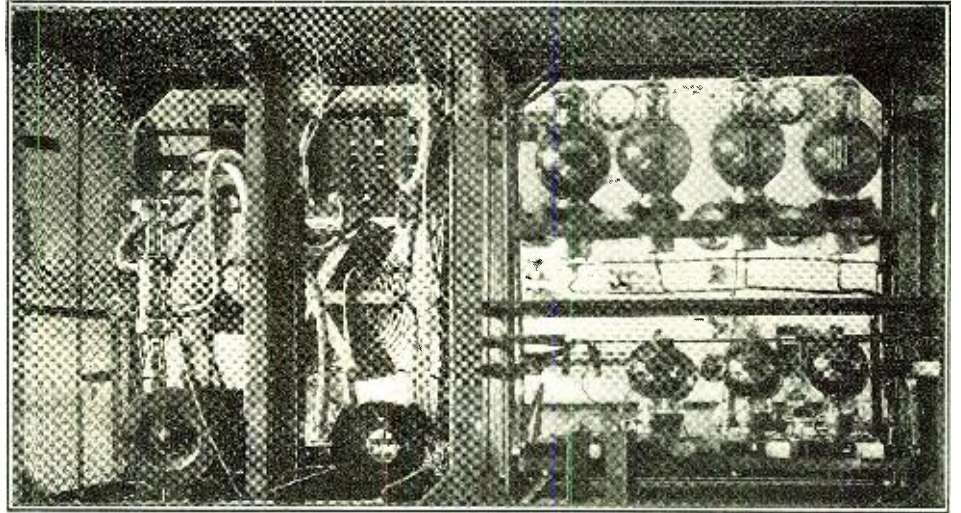

The Experimental Radiophone in Use at the Eiffel Tower Broadcasting Station. The New Tube is Used in This Transmitter as Power Amplifier and May Be Seen on the Left Mounted Above the Vacuum Pump.

(D. and E.) and the negative current is carried to one electrode (E.) by an insulated electrode (G.). The other electrode (D.) is joined to the metal cap to which can be soldered the connection to the positive pole of the supply. The filament consists of 36 cms. of tungsten wire 0.05 cm. in diameter. The heating current is of 36

the ratio of 8 to 10. Actually the valve is used so as to give an aerial power of 5 to 6 kilowatts.

This new valve is not costly, and is easily repaired by merely unfastening a few screws and bolts. It is light in construction, and will no doubt be adapted for use on ships, dirigibles, aeroplanes and everywhere where shock and vibration are likely to cause the breakage of the filament, the melting of the plate, or injury of the grid. Though at present it is only a commercial station's valve, we are looking forward to the day when a model will be obtainable suitable for the ambitious amateur who has the necessary power to run a small pump.

THE new high power vacuum tube described in this article is a departure in tube construction and embodies many novel features. The various parts composing the tube are assembled by means of rubber joints, and the tube may easily be taken apart for repair. It is not sealed, being permanently mounted on a vacuum pump which evacuates it constantly while the tube is in operation in a transmitting circuit. The pump itself is of novel design and is in fact part of the tube which develops 10 K.W., invented by a French engineer, Mr. Holweck.

amperes and the saturation point of the plate current about 6 amperes. The proper tension of the filament is assured by insulated rods (J. and H.) pressed down by a spring (K.).

The grid is carried by a split ring (L.) held by its own pressure in the glass tube (B.) which is joined to the plate in the manner already described. The grid is a spiral 1.8 cms. in diameter of molybdenum 0.04 cm. in diameter with 0.3 cm. pitch. The plate is 11 cms. long and has a diameter of 4.5 cms.

The vacuum necessary for the proper functioning of the valve is obtained by means of a special helicoidal molecular pump. This pump also invented by M. Holweck, can empty the valve in 30 seconds. During the whole time the valve is being used, the pump is working.

So efficient is this pump that it will cause the pressure in the valve to fall in 30 seconds to 1/1,000 of millimeter of mercury. Any air or gases released by the heated metals and glass disappear, and the tube works perfectly, once the preliminary vacuum is established.

With a tension of 5,000 volts on the plate, the power in the aerial is 8 kilowatts (35 amperes). With 4,000 volts, the power is still 5.8 kilowatts (30 amperes), which is in

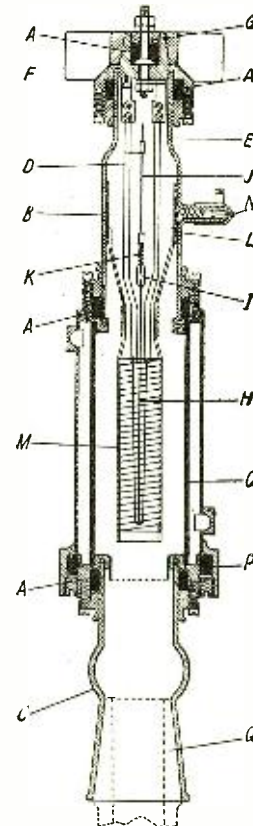

Diagram Showing How the Various Parts of the Tube Are Assembled Together. Rubber Joints Tightly Clamped Prevent Any Leakage.

Awards of the Reflex Prize Contest

Third Prize

Crystal Wins

By W. A. F. PYLE, Student A. I. E. E.

AT last the crystal has come into its own. Ten years ago it was the most revered part of an amateur's set, but with the advent of the vacuum tube it was relegated to the junk heap.

Were it not for the detector, no amount of radio or audio amplification would make possible radio communication as we have it today. The crystal as a detector is more or less of a mystery even to the best physicists. Its function as a rectifier of high frequency currents is well known, but the theory of its operation is still in doubt.

About a year ago the Bureau of Standards, through the medium of the Journal of the American Institute of Electrical Engineers and also RADIO NEWS, published an article featuring a tube amplifier with a crystal detector, using alternating current for filament heating current. Since that time the writer has made numerous experiments with radio and audio frequency amplification in connection with a crystal detector. Alternating current has invariably been used during these experiments for the filaments of the tubes.

The circuit about to be described is a modification of the inverse reflex. Such a circuit in combination with a crystal detector permits operation of a loud speaker on two tubes. Signals from a distance come in with nearly the intensity of stations only 25 miles away. The over-all efficiency of the vacuum tubes is much higher than usual, since they function both as radio and audio frequency amplifiers. The energy for the filament heating can be obtained from any 110-volt, 60-cycle, A. C. line. A General Electric Fort Wayne, 50-watt step-down transformer is used to change the potential to 8 volts. This transformer should be shielded and the shield connected to the ground.

The plate potential is obtained from the ordinary dry cell "B" battery, since this form of plate potential is far more satisfactory for the radiophone enthusiast than when any attempt is made to use rectified current. Less than 112 volts for "B" battery potential is not recommended and voltages of 135 volts or higher are desirable. Many sets give indifferent results when used with a loud speaker, because the variation of the plate current is small owing to the small plate potential.

Mr. Pyle Employs a Loose Coupler for the Purpose of Tuning His Two-Tube "Reflex Receiver. A Variocoupler Can Be Used With Equal Results.

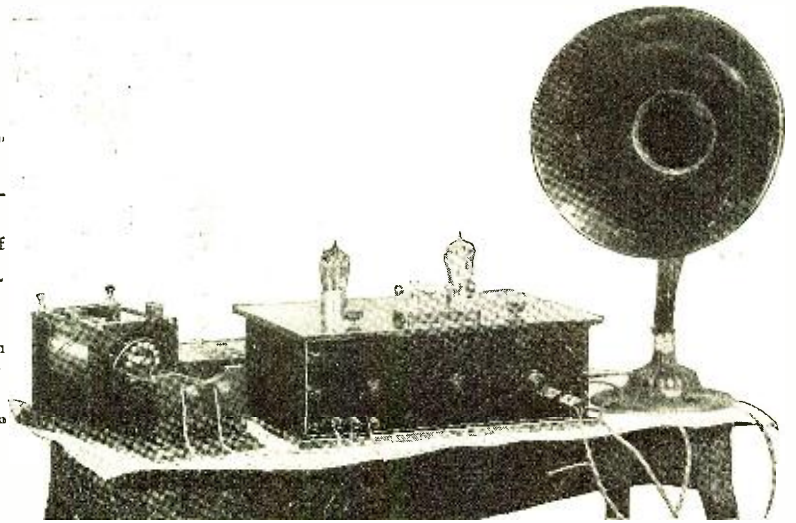

A "C" battery of from 4.5 to 9 volts is connected to the filament side of the transformer, of each of the audio frequency transformers as shown. This impresses a negative bias on the grids at all times, even when the tubes function as radio frequency

potentiometer is used for each tube, as it is not possible to keep both grids negative when a particularly strong signal is amplified, if only one potentiometer is used. Experiment has shown that tube amplifiers operating on alternating current should have the filament lead from each of the transformer secondaries connected to the midpoint of its respective potentiometer.

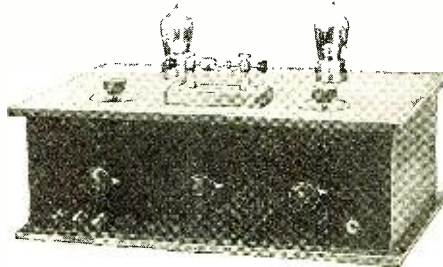

Another View of the Receiver Showing the Control Knobs of the Rheostat and the Potentiometer.

The negative lead of the "B" battery is connected to the midpoint of one of the potentiometers. Trial will show which potentiometer is the best since the correct connection gives a weaker residual alternating current hum in the loud speaker. Generally the potentiometer of the last audio frequency amplifying tube is found to be the best point for connecting the negative "B" battery.

amplifiers. Three or more flashlight cells may be used as a "C" battery. A strong negative bias on the grid is essential when the filament is heated by alternated current. Much clearer amplification results from the use of separate "C" batteries. The potentiometers used are 200 ohms of the type manufactured by the Radio Corporation. A

"Standard" audio frequency transformers are used. These are manufactured by The Standard Transformer Co., Warren, Ohio, and have a 1 to 5 ratio. These should be mounted so that their magnetic fields do not interlink. The grid lead of the secondary of each audio transformer is connected directly to the grid of the tube. The high impedance of the secondary of the audio transformer prevents the passage of any radio frequency currents. The audio transformer should be so designed as to carry a voltage of at least 150 volts without a breakdown due to the potential difference between the turns.

The radio frequency transformers used are Radio Corporation UV-712; these have a wave-length band of 200 to 500 meters and 500 to 5,000 meters. These transformers permit amateurs to pick up stations on commercial wave-lengths. The .001 mfd. condenser in the primary of the first radio transformer, the secondary of the first radio transformer, and primary of the second radio transformer, permits the passage of radio frequency currents, but will not permit the passage of audio frequency currents.

A galena detector was used, but any sensitive mineral will serve the purpose. If it is desired to use the head phones, a double jack may be inserted at the points marked XX. The experimenter will find there is not the slightest A.C. hum in the phones when using the tubes only as radio frequency amplifiers.

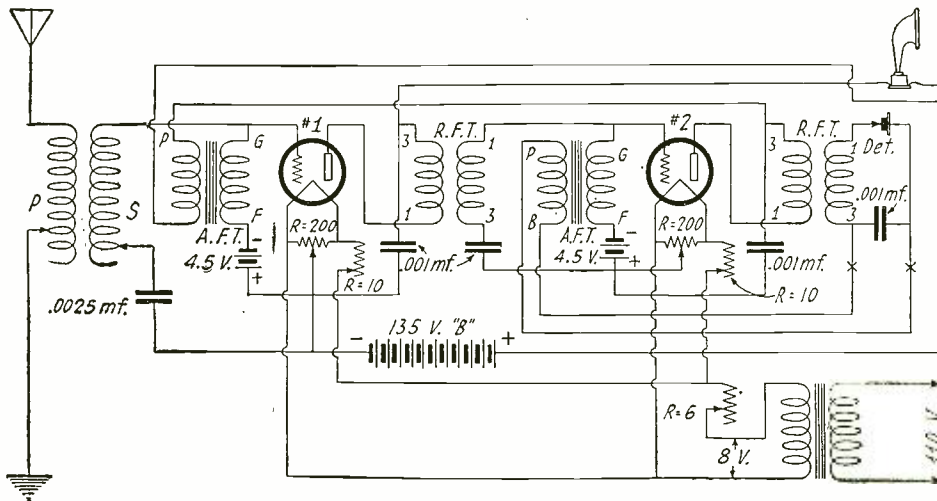

The Circuit Diagram of the Two-Tube Reflex Receiver Described in This Article. A Crystal Detector Is Used for Rectification. Note That Alternating Current Employed for Lighting the Vacuum Tube Filaments.

(Continued on page 819)

Construction Of Super-Heterodyne Receivers

By F. de WILLY and R. E. LACAULT

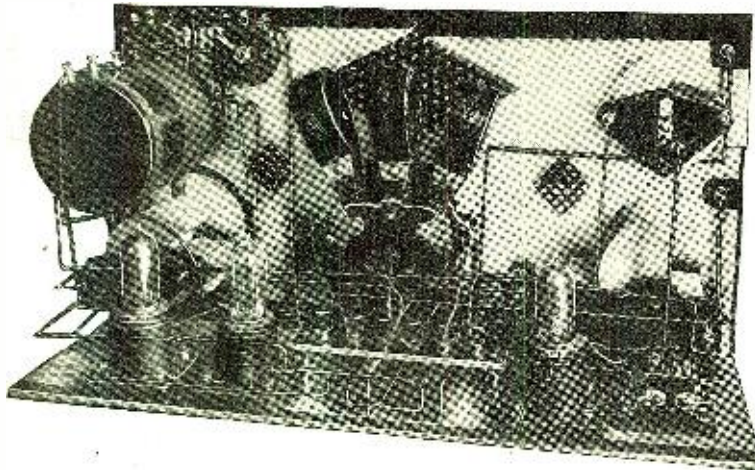

On the Left is an Inside View of Unit No. 1, Containing the Tuner and Oscillator. The Three Honeycomb Coils Constitute the Primary, Secondary and Feed-Back Circuits. The Oscillator Coil May Be Seen on the Left. On the Right is a Picture of the Complete Receiver in its Cabinet.

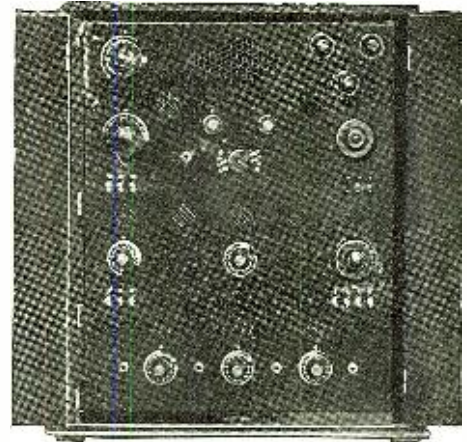

THE super-heterodyne method of reception presents all the advantages that are desirable for long range reception. It has been called the Rolls-Royce of radio and justly deserves this name, for no other system can compare with it for selectivity, range and ease of control. This method consists in lowering the frequency of the incoming signals which may then be efficiently amplified at radio frequency. Since all the signals received are reduced to the same frequency, the amplifier may be so designed that it will give very high amplification at this particular frequency. Either tuned circuits, transformers or choke coils are suitable for amplifying the long wave signals; if untuned radio frequency transformers are employed, tuned circuits connected between the last amplifier tube and detector provide the selectivity. These may be connected between the first detector, or rather, frequency changer and the first amplifying tube, but since, at this point the energy is weaker, a loss occurs which can only be gained by an additional stage of radio frequency amplification.

HOW IT WORKS

The lowering of the incoming signal frequency is accomplished by means of an oscillator or heterodyne, as it is called, coupled to the tuning system which may be a loop or an aerial with variocoupler. When the signal is received, the local oscillations interfering with it produce some beats, and it is these beats occurring at a certain frequency which are amplified and detected in the usual manner. For instance, if the radio frequency amplifier is permanently tuned to 50,000 cycles (6,000 meters), it is necessary to produce 50,000 beats, and to accomplish this, when receiving a 1,000,000-cycle (299.8 meters) signal, the heterodyne must be tuned to either 1,050,000, or 950,000 cycles (285.5 or 315.6 meters). This is readily accomplished by adjusting the variable condenser of the oscillator circuit once the tuning circuit has been adjusted to the proper wave-length. This produces extremely sharp tuning and results in extreme sensitiveness for the incoming signal is heterodyned.

The tuning of a super-heterodyne receiver is easy, for only two controls are necessary, one condenser for tuning the loop, or secondary circuit which may be coupled to an

aperiodic antenna and another to vary the frequency of the local oscillations produced by the heterodyne. If desired, tuned circuits

may be used in order to obtain greater selectivity through very heavy interference, but in practice it has been found that two controls are all that are needed.

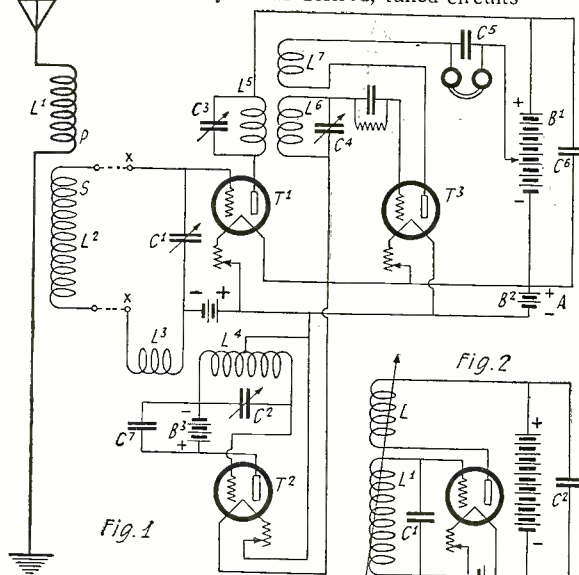

Circuit of a Simplified Super-Heterodyne Which May Be Set Up for Experiments. Instead of a "C" Battery, a Grid Condenser and Leak May Be Used in the Circuit of the Frequency Changer. Fig. 2 Shows the Hook-up of an Oscillator for Short Wave-Length Reception.

A SIMPLIFIED SUPER-HETERODYNE

One may obtain a very good idea of the selectivity and efficiency of the super-heterodyne method by using an ordinary long wave receiver with dual-lateral or honeycomb coils and an oscillator which may be built according to specifications given below. The diagram, Fig. 1, shows the connections of a three-tube super-heterodyne, with which we have obtained very good results. The first tube, T1, is the frequency changer which may be equipped with a grid condenser and grid leak as a detector. The tube, T2, is the oscillator and T3 is an ordinary detector tube connected to the long wave regenerative receiver. The tuning circuit consists of a fixed coupler that may be replaced by a loop connected in place of the secondary at the points marked "XX." The coupling between the pick-up coil L3, and the oscillator should be adjusted on a given signal for maximum audibility in the receivers. Once it is adjusted, it may be left fixed. The coils, L5, L6 and L7, are plugged in a standard three-coil mounting and constitute the transfer circuit between

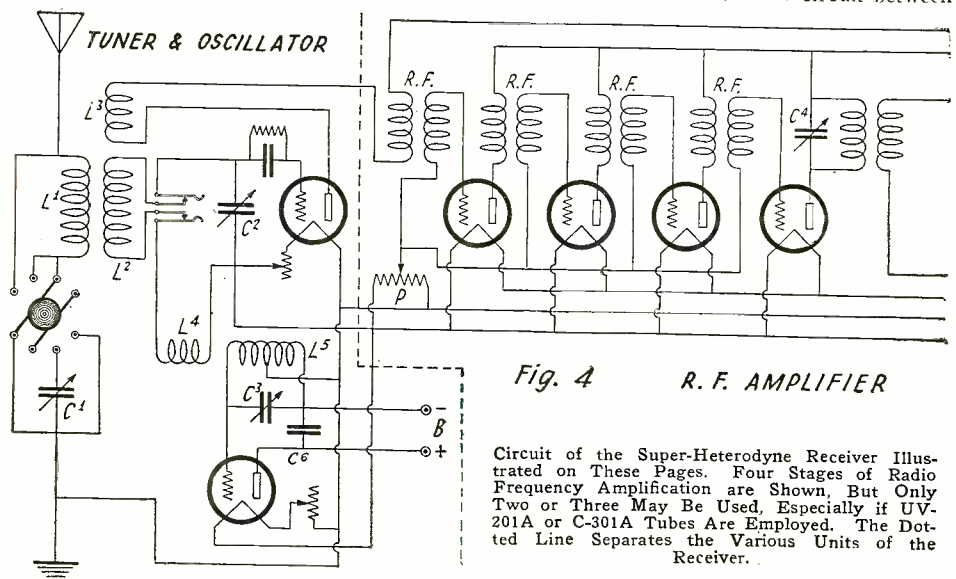

Circuit of the Super-Heterodyne Receiver Illustrated on These Pages. Four Stages of Radio Frequency Amplification are Shown, But Only Two or Three May Be Used, Especially if UV-201A or C-301A Tubes Are Employed. The Dotted Line Separates the Various Units of the Receiver.

the frequency changer and the detector, which may be made to oscillate for the reception of C.W. by coupling the feed-back coil, L7, to the secondary, L6. When receiving telephony, regeneration is accomplished in the usual manner by moving L7 toward L6 for maximum signal strength. If desired, the condensers, C3 and C4, may be fixed and of the same capacity if L5 and L6 are of the same size.

For the reception of very short wavelengths, such as are used by some amateurs during tests, it was found that an oscillator such as that shown in Fig. 2 was preferable to the simpler one illustrated in Fig. 1. When receiving weak signals it is sometimes of advantage to vary the strength of the local oscillations by moving the pick-up coil or by adjusting the filament rheostat of the oscillator tube.

In the circuit of Fig 1, the constants are as follows: L1 consists of five turns of No. 20 D.C.C. wire wound on a 4" bakelite or hard rubber tube. L2 is wound about 1/4" from L1 on the same tube and consists of 68 turns of the same wire. The pick-up coil L3 connected in series with the secondary or loop, may be from four to eight turns of the same wire wound on a 3" tube

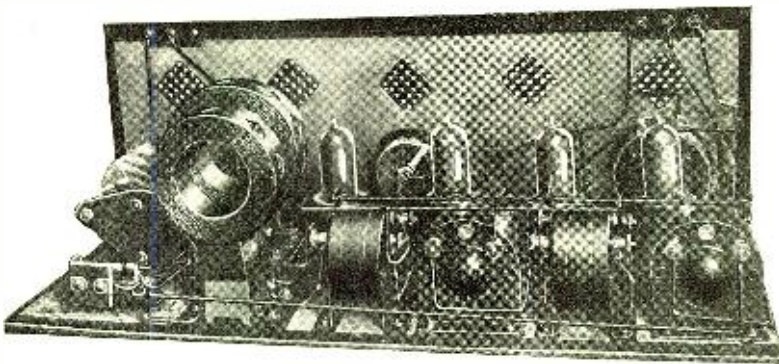

The Radio Frequency Amplifier and Detector Unit. The Long Wave Coupling Coils May Be Seen on the Left.

Inside View of the Three-Stage Audio Frequency Amplifier. Note the "C" batteries and the Panel to Which All Battery Connections Are Made. This Unit is Only Necessary When a Loud Speaker is Used.



capacity of .001 M.F. and C2 of .001 to .002 M.F.

AMPLIFIER MUCH MORE EFFICIENT

The circuit shown in Fig. 1, although very efficient, will not produce the same results as a regular super-heterodyne receiver equipped with a radio frequency amplifier on account of the limited amplification obtainable through the regenerative action of the detector. Instead, a long wave radio frequency amplifier may be employed coupled to coil L5; it may consist

together with the potentiometer control, provides stability in operation and high amplification. It is advisable to use a rheostat for each tube.

A type of radio frequency transformer which is suitable for use in a super-heterodyne receiver, is the Radio Corporation No. UV-1716; for those who do not wish to experiment, this will prove convenient, for they may assemble three of these to constitute the radio frequency amplifier of the receiver. In this case, only one tuned circuit is necessary placed as stated above, either between the frequency changer and the amplifier, or between the latter and the detector. The second method was employed in the super-heterodyne receiver which is shown in the accompanying photographs. This set was built for broadcast reception and was assembled in a cabinet, as shown, on account of lack of space which did not permit its installation hook-up fashion. It is made in three units, the first one containing the tuner and oscillator, the second, radio frequency amplifier and detector, and the third, the audio frequency amplifier. Each

which may also be used to wind the oscillator coil L4, which is composed of 46 turns of No. 20 D.C.C. wire. A tap is taken in the center of the winding for the return to the filament. The tuning condenser, C1, has a capacity of .0005 M.F. and C2 of .001 M.F. The coils L5 and L6 may be two 500-turn honeycomb or duo-lateral coils shunted by condensers C3 and C4, of .0005 M.F. capacity, which may be fixed. L7 is the feedback coil for obtaining regeneration and oscillations in the detector circuit, and may be a 150 or 200-turn coil. The other constants of the circuit are as follows: C5,

of two or three stages with choke coil or transformer coupling. We have experimented with various types of coupling such as shown in Fig. 3 and found it possible to make very efficient transformers and choke coils with ordinary duo-lateral coils connected as shown. Two coils may be clamped together so as to form a transformer or a single coil may be employed as a choke coil in the plate circuit. Each stage may be tuned with fixed condensers provided they are all exactly of the same capacity, or else larger coils may be used at their natural period. The grid voltage of the amplifi-

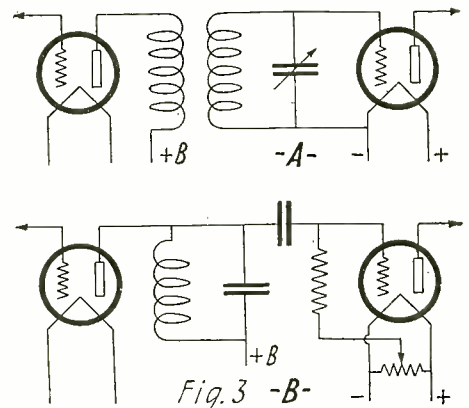
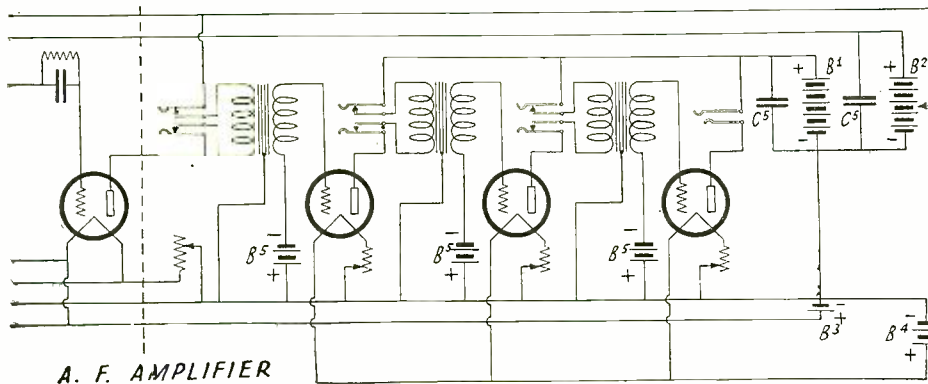

Fig. 3 -B-

Two Methods of Coupling Which May Be Used in the Long Wave R.F. Amplifier. The Transformer and Choke May Be Duo-lateral or Honeycomb Coils.



A. F. AMPLIFIER

.002 M.F. condenser; C6, .5 M.F. to 1 M.F.; B2, filament battery; B1 and B3, 45 to 90 volts; C7, .001 M.F. The coils of the oscillator shown in Fig. 2 may be wound on two pieces of tubing 3" in diameter, mounted so that the coupling between the two may be varied. L consists of 15 turns of No. 20 D.C.C. wire and L1 of 20 turns of the same wire. The variable condenser, C1, has a

ing tubes may be controlled with a potentiometer in the usual manner.

The construction of a radio frequency amplifier using one of the above type of coupling requires care to prevent interaction between the stages and self-oscillations starting through feed-back and stray capacities. Shields may be employed, or the stages may be spaced sufficiently far apart and this,

unit is carefully shielded as well as the cabinet itself, in order to prevent feed-backs and inductive effects between the various circuits. For convenience, since it was not possible to use storage batteries, low consumption tubes were employed throughout with dry cells as filament supply. In order to obtain more strength in the heterodyne circuit, two tubes were connected in parallel, but with individual rheostats, so that only one may be employed if desired. For ordinary purposes, only one tube is required, but two were necessary in some experiments which we carried out with this outfit. The tuner consists of honeycomb coils connected in a standard circuit and a jack is provided so that a loop may be substituted for the secondary coil when necessary.

As may be seen in the photograph, the three coils are mounted inside of the cabinet and the coupling controlled by means of knobs mounted on long shafts. The radio

(Continued on page 823)



Simplifying the Radio Receiving Set

By JAMES ASHTON GREIG, B. S., E. E.

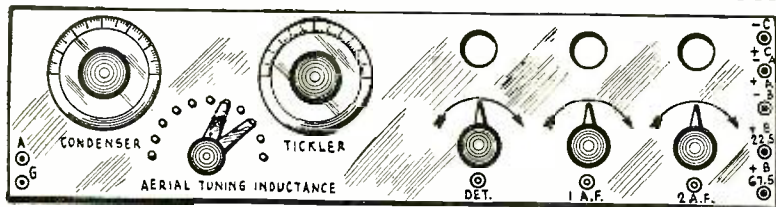

Fig. 1

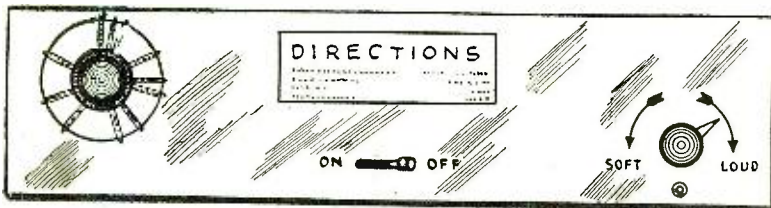

Fig. 2

By Correct Design Most of the Variable Units in Fig. 1 Can Be Made Constant, at Certain Values, and the Receiver Controlled by a Single Knob and Dial, As in Fig. 2.

Tut's tomb. Supposedly for enlightenment, but actually adding further confusion to the matter, are such signs as "Aerial Tuning Inductance," "Tickler," "Primary Condenser," "Secondary Condenser," "Detector," and a lot of other terms which could just as logically be written in the Greek language for all the real help they afford to the man or woman who knows nothing about radio.

Is it any wonder that the business man soon concludes that the radio set is a nice plaything for the young fellow with a mechanical turn of mind, but that it has not yet been perfected to the extent of having utilitarian value? He judges the business of radio by the principles of his own business and knows that they do not compare.

How much of a market would the talking machine have if the motor speed indicator, instead of being marked with the simple words "Slow—Fast" were to strike the eye with some such message as "Internal Acceleration Regulator," or some other gibberish?

EXPERIMENT in the improvement of the design of radio receiving apparatus today is not confined to the private laboratories of manufacturers of radio apparatus, nor to government bureaus of research, but extends throughout the country among an army of well organized amateurs and indeed to practically every owner of a radio receiving set in the nation.

No one can question the fact that this power of concerted effort, if directed along intelligent lines, will be of as much benefit to radio in the future as it has been in the past, which is saying a good deal. However, there seems a danger that one very important factor in the future progress of radio may be neglected. To properly understand this factor one must have a knowledge of the types of persons who are at present classified under the general term "the radio market."

Roughly, these are of two kinds, i.e., the experimenting type and what might be termed the utilitarian type. In the first classification may be included not only the radio amateurs, young and old, but also a large number of novices who are born with a natural desire to tinker and who find in the medium of a radio set a fertile if provocative outlet for these desires.

The second classification is composed of what the writer believes to be the real radio market of the future. These are adult men and women who have no knowledge whatever of the complexities of a radio set nor any desire to learn about them. It is the utilitarian value of the apparatus which alone appeals to them. If they can get good music, useful information or entertainment at the press of a button or the turn of a switch, then they will give radio their unqualified endorsement, but not otherwise.

Can we honestly say that we have given

them this? Let us look at this thing in the cold light of the facts, for, mark you, it is this class of buyer who is looked upon to furnish capital with which the industry is to mortgage its future progress.

The writer is moved to make these few remarks from the constantly increasing number of busy industrial executives who have been "bitten by the radio bug," as many of them expressed it, and who want to know what kind of a set to buy. The least complicated set is, needless to say, the one which is always recommended, yet in colloquial parlance, "there ain't any such animal."

Consider the typical example. A man who knows nothing whatever about radio sits down before a black box from which a formidable array of controls and binding posts issue. Before he can enjoy the broadcasting which he wants to get he must figure out the Siamese puzzle of how to connect the thing up to its batteries. On the black box there are at least five dials and indeed in some cases there are 20 or more. Some of these are marked with numbers from 0 to 100 which have as much meaning to the uninitiated as the scroll on King

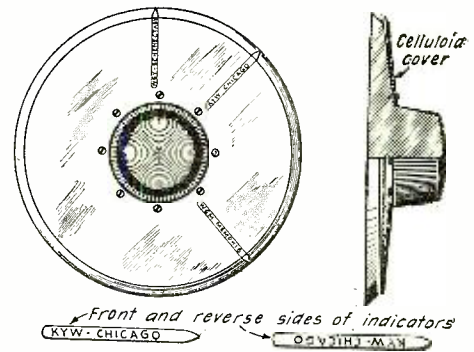
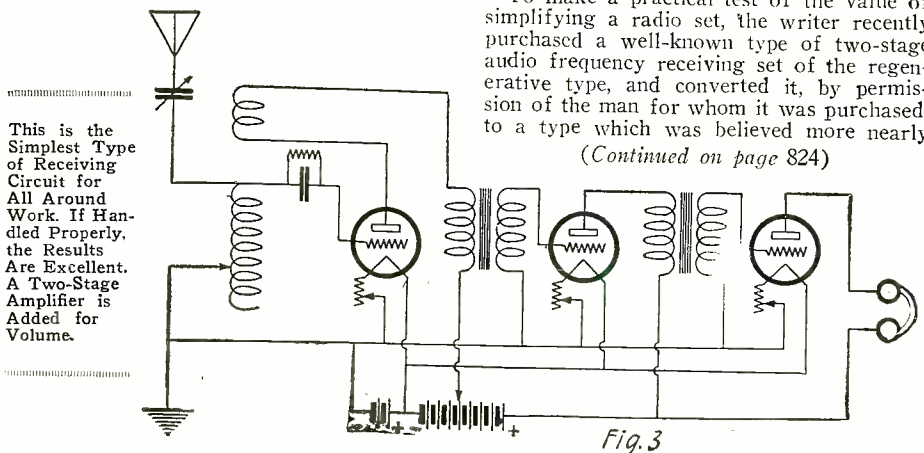

Fig. 4
Showing the Reconstructed Knob and Dial Which is Used with the Uni-Control Receiver.

The radio business is a highly technical field and has consequently accumulated in its executive personnel a preponderance of engineers and a dearth of practical business men, but this condition should not be allowed to stand in the way of its progress.

To make a practical test of the value of simplifying a radio set, the writer recently purchased a well-known type of two-stage audio frequency receiving set of the regenerative type, and converted it, by permission of the man for whom it was purchased, to a type which was believed more nearly

(Continued on page 824)



This is the Simplest Type of Receiving Circuit for All Around Work. If Handled Properly, the Results Are Excellent. A Two-Stage Amplifier is Added for Volume.

Fig. 3

*Formerly radio engineer with the Marconi Wireless Tel. Co. of America.

Audio Frequency Amplification

By LOUIS FRANK

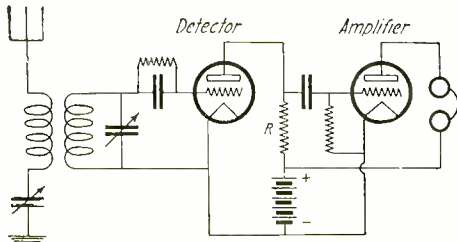

Fig. 1

A Circuit Comprising a Detector and One Stage of Resistance Coupled Audio Frequency Amplification.

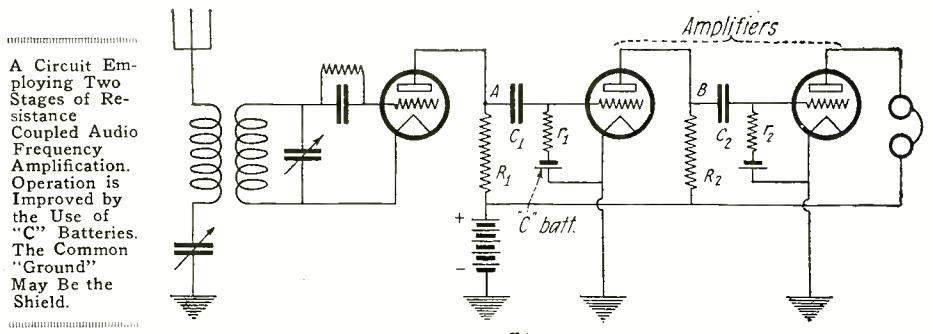

Fig. 2

THE last article of this series explained how it was possible to increase the distance range of a set by means of "radio frequency amplification." It was also explained that radio frequency amplification increased the intensity of the received signal so that it could be detected most efficiently. The signal which is detected is now audible, but, as the reader has probably found out, it is audible only in a pair of telephones. This makes it inconvenient when more than one or two persons desire to listen to the broadcasting. In such a case it is very desirable to have some means whereby the signals will be heard throughout an entire room by any number of persons. In order to make this possible it is necessary to employ another

ical to consider in detail the workings of audio frequency amplifiers.

Just as in radio frequency amplification (see October, 1923 issue of RADIO NEWS), all modern methods of audio frequency amplification are based on the amplifying properties which are inherent in the vacuum tube. Every vacuum tube with three electrodes is a natural amplifier and is capable of a certain amount of amplification. The three-element vacuum tube is the device which is used by telephone companies to bring up the intensity of speech in long distance telephony. It is unique in that if a very small voltage is applied between the grid and the filament of the vacuum tube a very large current will flow in the circuit between the

coupled amplifiers. Each of these systems has merits, as well as some disadvantages. These systems will therefore be considered in order.

RESISTANCE COUPLED AMPLIFIERS

Fig. 1 illustrates a simple resistance coupled amplifier using a single tube. The signal is applied to the grid of the amplifier tube, and is obtained from the detection of radio frequency currents; the signal is then repeated or amplified in the plate circuit of the tube. An enlarged copy of the original signal then appears as an amplified voltage across the plate resistance R. This voltage will then drive a large current through the head-telephones, producing a loud signal. In Fig. 2 is shown a two-stage audio frequency resistance coupled amplifier. The reason it is so called is that resistances R1 and R2 are used to couple the amplifier tubes to one another. In the case of the two-step resistance amplifier, the large audio signal developed across plate coupling resistance R1 is applied to the grid of the first amplifier tube. This is then amplified still more and a larger signal is developed across the second plate resistance which is applied to the grid of the second amplifier tube, and the telephones then give the largely magnified signal.

In using a resistance coupled amplifier it is necessary, for best results, that the plate coupling resistances R1 and R2 be two or three times the resistance of the amplifier tubes themselves. The greater this resistance is the greater will the amplification be. For practical purposes considering the type of tubes made today, these resistances should be about 20,000 ohms to 40,000 ohms in value; if the latter, it will be suitable for any type of tube. In making such an amplifier as shown in Fig. 2, the amateur should include the grid condensers C1 and C2, which serve a very important purpose. It will be observed in Fig. 2, which shows the complete details of a two-stage resistance coupled amplifier, that the positive side of the plate battery is connected to the plates of the tubes through the

(Continued on page 746)

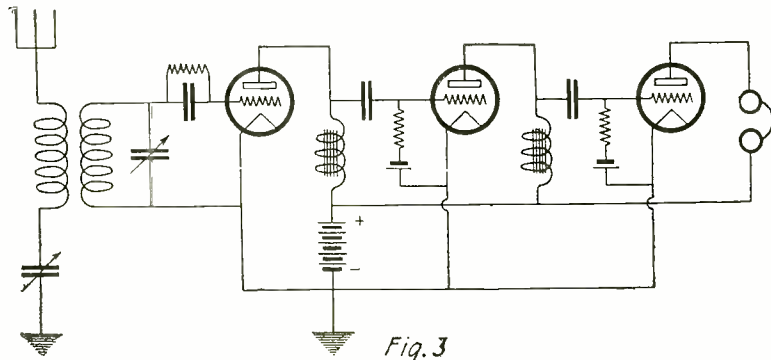

Fig. 3

Slightly Better Results Are Obtained with Reactance Coupled Audio Amplifiers Utilizing Iron Core Choke Coils.

form of amplification, or "audio frequency amplification", so-called because this system amplifies the audible signals which come out of the detector. What audio frequency amplification does, therefore, is to increase the intensity or loudness of the received signal after it is detected. Audio frequency amplification does not help you to receive over long distances, it merely increases the volume of the signal after it has already been received and detected.

With respect to the relative positions of radio frequency and audio frequency amplification, as used in a radio set, it might be mentioned that the former is used before the detector, whereas the latter is used after the detector. Radio frequency amplification with a detector alone will give you long distance reception in a pair of headphones; audio frequency amplification used in conjunction with a detector only will give you short or medium distance reception (depending upon the type of detector employed, a regenerative receiver and detector giving the medium distances) with sufficient loudness or volume to operate a loud speaker; the use of radio frequency amplification before a detector, and audio frequency amplification after the detector will enable the reception of long distance broadcasting and at the same time permit the use of a loud speaker. Since previous articles in this series have been concerned with detection and radio frequency amplification it is log-

plate and filament of the tube when there is a positive voltage on the plate. Small voltages and small current variations in the grid circuit produce large voltages and large current variations in the plate circuit if the circuit is properly wired and designed. Thus, weak signals, if applied to the grid circuit of the tube, may be brought up to very loud signals in the plate circuit by the amplification of the tube.

The above basic principle of the vacuum tube amplifier is applied in the construction of the various types of audio frequency amplifiers, the three main types of which are: (1) Resistance coupled; (2) inductance or reactance coupled; and (3) transformer

Transformer Coupled Audio Amplifiers Are by Far the Best. They Are, However, More Subject to Distortion Than Other Types Unless the Ratio is Low.

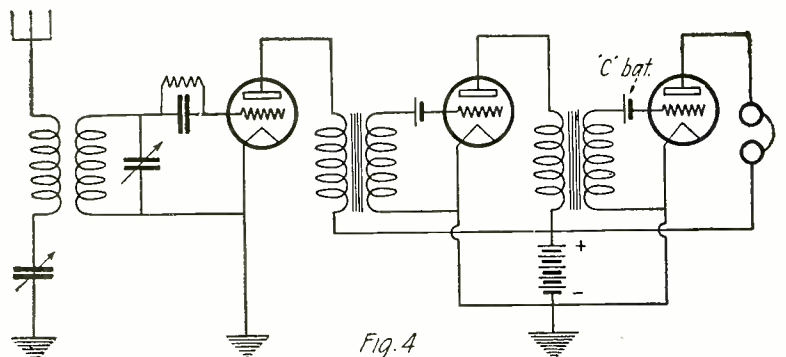
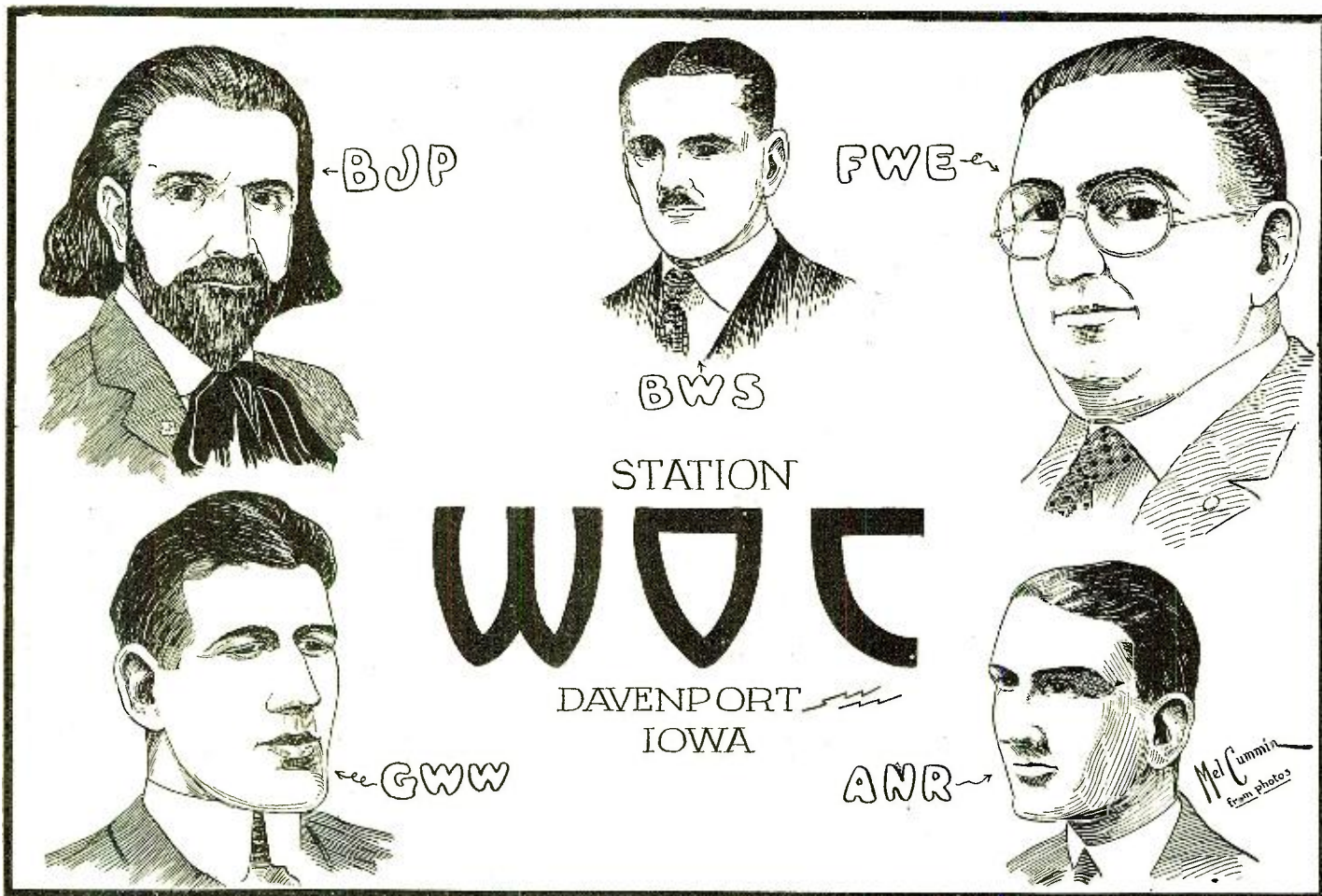

Fig. 4

Heard But Not Seen



The Managing and Operating Force of Station WOC, the Palmer School of Chiropractics, Davenport, Iowa. Just How Many of Them Are "Bone Specialists" is Hard to Say. But Judging from Appearances We Would Say That "BJP" Was the Royal Chief and Wizard of the Whole Works. We Take Our Hats Off to These Men, Who Have Done So Much in Helping to Make Broadcasting Worth While. The Programs from WOC Are of the Highest Class; Truly a Pleasure to Listen To, Which is Saying Much.

A Complete Radio Library at Amateur Price

By S. R. WINTERS

ANY person in the United States, Canada, Cuba, or Mexico, may acquire 38 publications on the subject of radio—a veritable library—for the trifling sum of \$5.85! No, this is not an advertisement of a proposition for purchasing books on the installment plan—one dollar down, and two dollars a month until the obligation is cancelled—nor is it the introduction of a home-correspondence course in wireless telephony and telegraphy. There is a semblance of advertising in this offer, but if all the readers of RADIO NEWS responded with remittances of \$5.85 each, the seller would not profit one whit from the transactions.

For, when the Federal Government uses printer's ink, the cost of this fluid and paper on which the words are imprinted are not levied directly upon the purchasers of the publications. Of course, your income tax or excess profits tax may be drawn upon as sources of revenue when Uncle Sam goes into the printing business, but that is another story! By virtue of the fact that the Government Printing Office, Washington, D.C.,—the largest printery in the world—is a public institution, a 60-page radio publication can be printed and mailed across the continent for ten cents. Or, the purchase price of approximately 40 publications on wireless telephony and telegraphy is less than six dollars, no postage being required of any

purchaser in the United States and its possessions.

The subject matter treated by the various branches of the Federal Government ranges from a discussion of antenna systems to an exposition of the relation between a radio mechanic and aircraft. Of course, you can not expect Uncle Sam to clothe his radio publications in morocco or buckram when they qualify for admission into the modern five-and-ten-cent stores. In the majority of instances, they are issued in pamphlet form, with obvious paper covers. The colors of the latter vary from an orange-like hue—a color to which the Signal Corps is partial—to unadorned white, the covers and body of the latter being alike: Notable exceptions to the publications issued with paper bindings, are the copies of "Commercial Traffic Regulations" and "Principles Underlying Radio Communications," the former having cloth covers, and the latter being bound in fabrikoid.

"The Principles Underlying Radio Communication," a book of 619 pages, is quite the most readable and comprehensive treatment of radio telephony and telegraphy yet issued in printed form by the Federal Government. It was prepared by the Radio Laboratory of the Bureau of Standards, United States Department of Commerce, in collaboration with physicists at Union University, Purdue University, Yale Uni-

versity, Ohio State University, and Clarkson College of Technology. Although primarily designed for use by the Training Section of the Signal Corps, War Department, copies may be obtained from the Superintendent of Documents, Government Printing Office, Washington, D.C., at a price of \$1.00 each. The title of this book is adequately suggestive of its contents, the 619 pages and more than 300 illustrations running the gamut of electricity and electrical machinery, discussing understandably their applications to radio communications.

In elaborateness, Circular No. 74 of the Bureau of Standards, entitled "Radio Instruments and Measurements," is of ranking proportion to the book referred to in the preceding paragraph, among the efforts of the Government in the treatment of radio by use of printer's ink. This book extends to a length of 314 pages, and is sold by the Government Printing Office at a price of 60 cents a copy. A variety of wireless measurements is outlined between its covers, and the technique of the science of radio is unfolded to a considerable extent. If the consuming interest of the novice has not advanced beyond the stage of the crystal-detector receiving set, or if he is merely obsessed with the "Itch for Distance," this publication will have little appeal. If, however, you are desirous of determining the

(Continued on page 758)

Fertile Florida

By ARMSTRONG PERRY

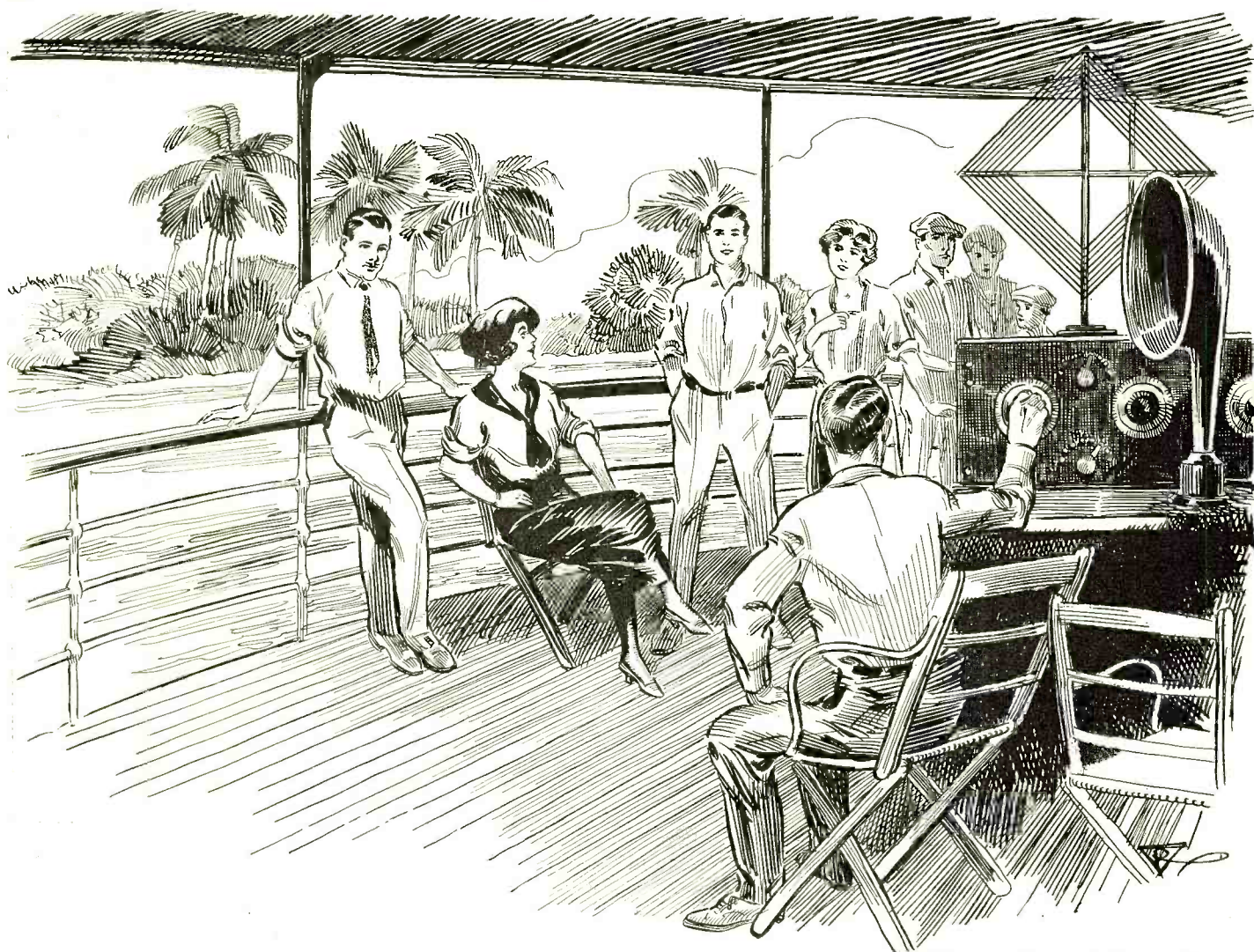

The People of Florida Have Yet to Find the Pleasure They Can Derive From Radio. There Are But Few Who Own Sets at the Present Time.

THERE are some towns, cities and states which, because of favorable situation or circumstance, acquire an importance which their area and population alone could not give them. Washington, D. C., for instance, because it is the seat of national government, attracts visitors from everywhere and gives to any event that happens within its borders

a significance that it would not have if it took place elsewhere.

Florida is such a State. Poking its toe out into the waters of the Atlantic and the Gulf of Mexico, at the southern extremity of our eastern coast, it is in a sense isolated, but the growing desire of folks to be warm in the winter in spite of coal strikes brings to it swarms of visitors from every state in the union. Even Californians, who believe that their state is the only genuinely desirable bit of real estate in the world, go to Florida for they fear that if they don't, Florida will put something over on them. They say nice things about Florida, too, possibly to lull Floridans into a state of self-satisfaction and prevent their rising up in arms against the preferential transportation rates that enable California fruit to travel three times as far and push the Florida products out of the eastern markets.

or a tent somewhere on the outskirts of a truck gardening community, and gets a job. The small town merchant leaves the store with the boy, takes Mom in the flivver and makes a tin can tour to the land of sunshine. The horseshoe fingers of the nation would no sooner miss the national championships in Florida than they would their morning coffee. But aside from the proletariat, Florida attracts an astounding number of the leaders of the nation—political, social, financial, industrial, literary, artistic, moving picture and baseball.

Life at a Florida resort is less crowded than in the northern cities. Little events that would pass without notice at home command the attention of men of great wealth and power. Attend a dance given by the Fifty Thousand Club of Fort Myers and you are apt to find yourself face to face on the floor with Mrs. Henry Ford discussing the habits of burrowing owls with Thomas A. Edison and Harvey Firestone on a bench at the side of the pavilion. In Miami of course every visitor sees William Jennings Bryan or, if he is out lecturing, chats with his interesting gardener, who used to play baseball in New York on the Waldorf-Astoria team with John Jacob Astor. Connors of Buffalo and New York is seen building a road across from the Atlantic coast to Lake Okeechobee. Barron G. Collier is building a longer one through

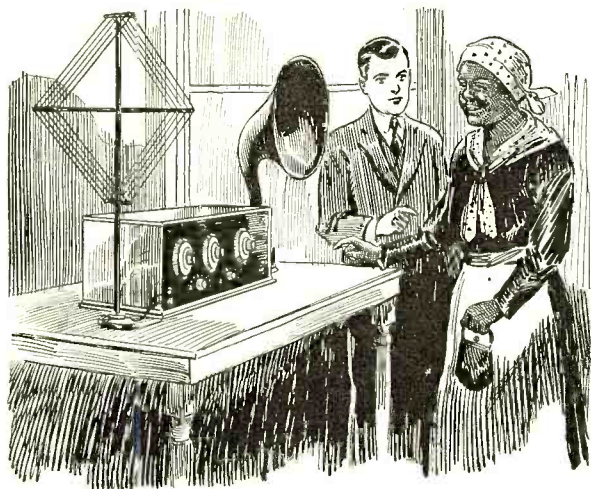

There Are Any Number of People Who Would Be Glad to Invest in a Radio Set if They Knew the Benefit it Would Bring. It is Up to Someone to Create an Interest.

(Continued on page 778)

Solander's Radio Tomb

By ELLIS PARKER BUTLER

Author of "Pigs is Pigs"

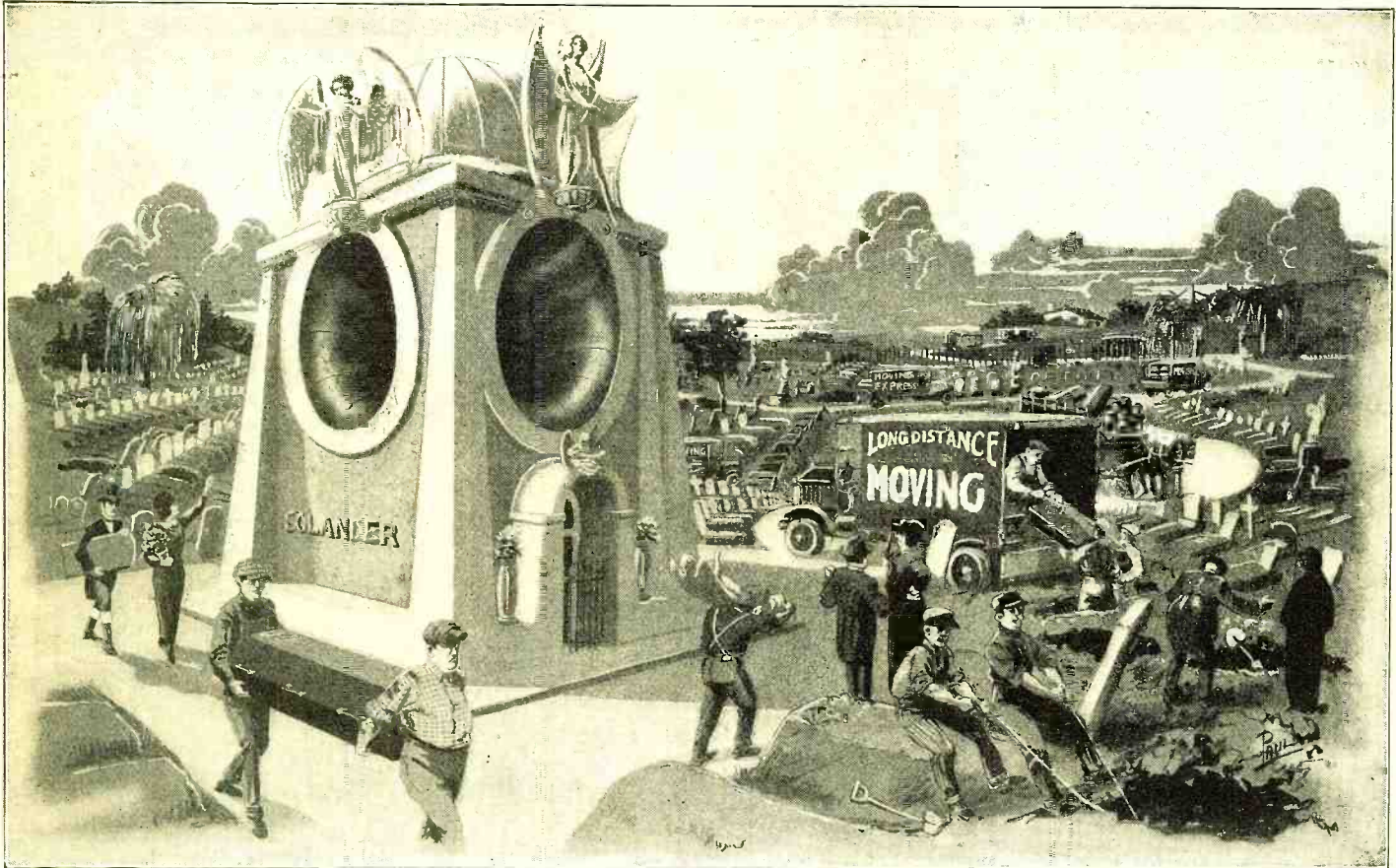

Within a Week the Inmates of Our Cemetery Began to Move Out. Friends of People Who Had Been Buried There Over a Hundred Years Came and Moved Them to Other Cemeteries and Took the Headstones and Monuments With Them, and in a Month Our Cemetery Looked Like One of Those Great War Battlefields—Like a Lot of Shell-Holes. Not a Man, Woman or Child was Left in the Place—Except Remington Solander in His Granite Tomb on the Top of the High Knoll.

I FIRST met Mr. Remington Solander shortly after I installed my first radio set. I was going in to New York on the 8:15 A. M. train and was sitting with my friend Murchison and, as a matter of course, we were talking radio. I had just told Murchison that he was a lunk-headed noodle and that for two cents I would poke him in the jaw, and that even a pin-headed idiot ought to know that a bulb set was better than a crystal set. To this Murchison had replied that that settled it. He said he had always known I was a moron, and now he was sure of it.

"If you had enough brains to fill a hazelnut shell," he said, "you wouldn't talk that way. Anybody but a half-baked lunatic would know that what a man wants in radio is clear, sharp reception and that's what a crystal gives you. You're one of these half-wits that think they're classy if they can hear some two-cent station five hundred miles away utter a few faint squeaks. Shut up! I don't want to talk to you. I don't want to listen to you. Go and sit somewhere else."

Of course, this was what was to be expected of Murchison. And if I did let out a few laps of anger, I feel I was entirely justified. Radio fans are always disputing over the relative merits of crystal and bulb sets, but I knew I was right. I was just trying to decide whether to choke Murchison with my bare hand and throw his lifeless body out of the car window, or tell him a few things I had been wanting to say ever since he began knocking my bulb set, when this Remington Solander, who was sitting behind us, leaned forward and tapped me on

the shoulder. I turned quickly and saw his long sheeplike face close to mine. He was chewing cardamon seed and breathing the odor into my face.

"My friend," he said, "come back and sit with me; I want to ask you a few questions about radio."

Well, I couldn't resist that, could I? No radio fan could. I did not care much for the looks of this Remington Solander man, but for the last few weeks my friends had seemed to be steering away from me when I drew near, although I am sure I never said anything to bore them. All I ever talked about was my radio set and some new hook-up I was trying, but I had noticed that men who formerly had seemed to be fond of my company now gave startled looks when I neared them. Some even climbed over the nearest fence and ran madly across vacant lots, looking over their shoulders with frightened glances as they ran. For a week I had not been able to get any man of my acquaintance to listen to one word from me, except Murchison, and he is an utter idiot, as I think I have made clear. So I left Murchison and sat with Remington Solander.

In one way I was proud to be invited to sit with Remington Solander, because he was far and away the richest man in our town. When he died his estate proved to amount to three million dollars. I had seen him often, and I knew who he was, but he was a stand-offish old fellow and did not mix, so I had never met him. He was a tall man and thin, somewhat flabby and he was pale in an unhealthy sort of way, but, after all, he was a millionaire and a member of one of the "old families" of Westcote, so I

took the seat alongside of him with considerable satisfaction.

"I gather," he said as soon as I was seated, "that you are interested in radio."

I told him I was.

"And I'm just building a new set, using a new hook-up that I heard of about a week ago," I said. "I think it is going to be a wonder. Now, here is the idea: instead of using a grid—"

"Yes, yes!" the old aristocrat said hastily.

"But never mind that now. I know very little of such things. I have an electrician employed by the year to care for my radio set and I leave all such things to him. You are a lawyer, are you not?"

I told him I was.

"And you are chairman of the trustees of the Westcote Cemetery, are you not?" he asked.

I told him I was that also. And I may say that the Westcote Cemetery Association is one of the rightest and tightest little corporations in existence. It has been in existence since 1808 and has been exceedingly profitable to those fortunate enough to hold its stock. I inherited the small block I own from my grandfather. Recently we trustees had bought sixty additional acres adjoining the old cemetery and had added them to it, and we were about ready to put the new lots on the market. At \$300 apiece there promised to be a tremendous profit in the thing, for our cemetery was a fashionable place to be buried in and the demand for the lots in the new addition promised to be enormous.

"You have not known it," said Remington Solander in his slow drawl, which had the

(Continued on page 804)

Radio Oddities



What Has Apparently Solved the Problem of Making a Radio Set a More Appropriate Accessory for Milady's Boudoir, is This Radio Outfit, Tastefully Trimmed with Silk Ribbons. Miss Jean Tolley, Radio Enthusiast, Has Originated This Idea, so That Her Radio Will Harmonize with the Surroundings of Her Room. © Kadel & Herbert.



General Scene of the Wyoming Indians Listening to the Radio for the First Time. Left to Right Are Seen: Mr. and Mrs. Red Turtle, Setting Eagle, White Bull and Red Fox. © Kadel & Herbert.



A Curious Sight These Days in Boston is the "Little Radio Church on Wheels." The Very Latest Thing in Ecclesiastical Architecture. The Radio Outfit and Loud Speaker Can Be Seen on the Platform. © Gilliams Service, New York.



The Four-Stage Vacuum Tube Amplifier in the Laboratories of the Western Electric Company. Passengers on Liners Going Down the Hudson Can Plainly Hear Farewell Messages. © Fotograms.

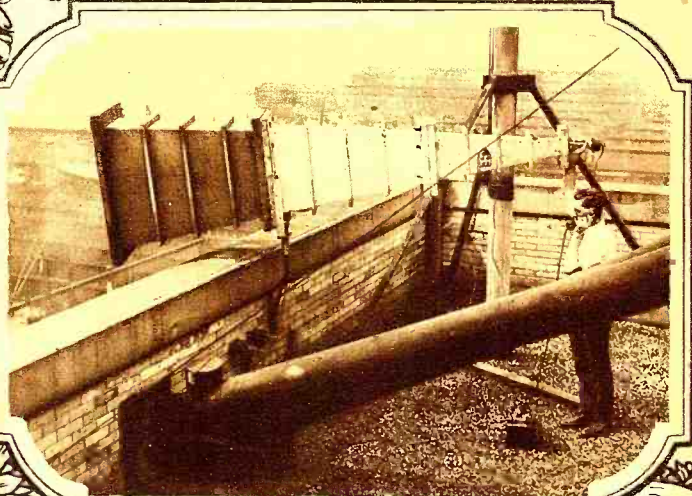

The Large Horn Used in Conjunction with the Four-Stage Power Amplifier Shown in the Left-Hand Photo. It Amplifies the Human Voice 10,000 Times. © Fotograms.

Commercial Possibilities of Wired Radio for Central Stations

By BERT T. BONAVENTURE

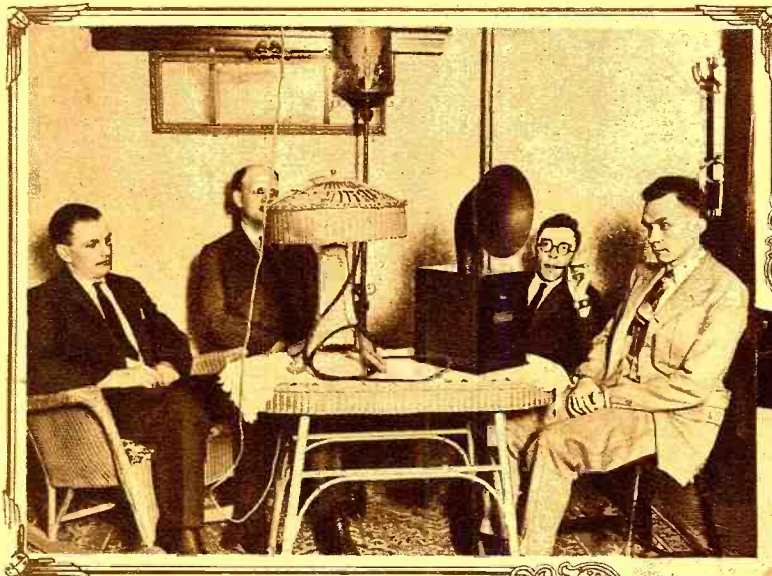

A Specially Designed Receiver for Use With Wired Radio. A Concert is Being Received Over the Light Line.

radio transmitter was radiated in all directions, with its consequent rapid attenuation, in the wired radio scheme, the high frequency energy is guided to its destination by the above mentioned wire system. Thus with relatively small powers, comparatively large areas may be effectively served with broadcast entertainment.

Since the beginning, people everywhere have become radio fans, and several interesting developments have taken place. For instance a fan may have wondered why his

WHEN we speak of "Wired Radio," the question naturally arises, "Is that a trick name for some old stunt, or is it something new?" Candidly, we may reply that wired radio is neither. It is not a trick name to catch the public eye for the name "wired radio" is the only logical one out of a host of synonymous nomenclatures, such as lined radio, wired wireless, carrier telephony, and others similarly associated. It is not new, in the sense that it was brought to the attention of the public in 1911, by Major General G. O. Squier, its inventor.

What then differentiates wired radio from ordinary space or ether radio? The only essential difference is the use of a wire system which joins the transmitting and receiving apparatus. The terminal apparatus is almost identical in both systems. This metallic wire circuit need not necessarily be a continuous line circuit from transmitter to receiver, since the method is applicable for operation over the numerous branches of the lighting network of a city, containing hundreds of distribution transformers and spreading out in all directions. It is also in this connecting link between transmitter and receiver, that the advantage of the system lies. Where before, the energy of a

Above: A Wired Radio Transmitter Employed by the North American Company at Staten Island for Experimental Purposes. Below: The General Arrangement of a Radio Broadcast Station.

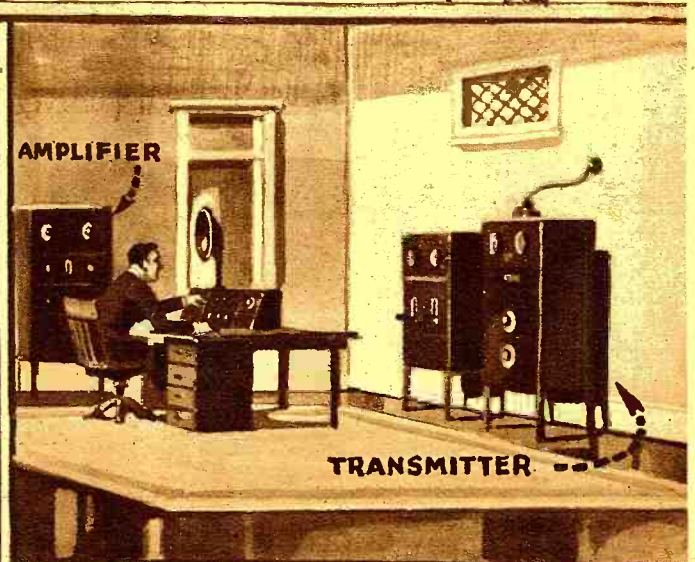
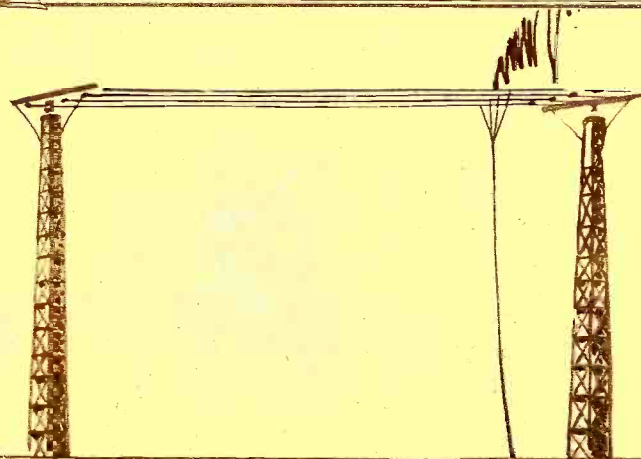
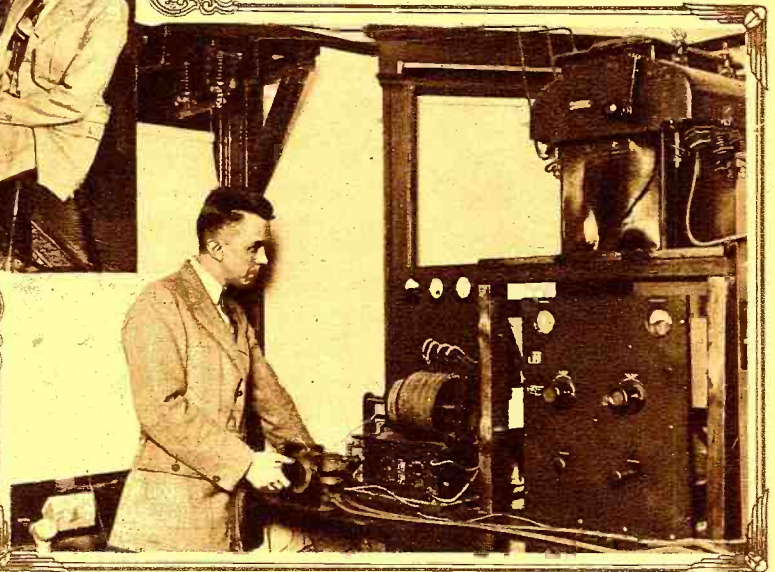



An Aerial and More Elaborate Apparatus is Usually Required for the Reception of Radio Broadcasting. The Apparatus for the Reception of Wired Radio As Shown Below is Quite Simple and no Aerial is Necessary.



lighting bill suddenly jumped upward when the radio outfit was bought. Of course few of the enthusiasts stop to think of the reason for this change in electric light bills. The fact that they are at home more often in the evenings hardly seems to be a significant factor in their analysis. Coupled with this suddenly acquired taste for home, it is easily seen that tinkering and putting around with his radio set keeps the fan up until all hours of the night—with the lights burning. Then, too, the additional electrical equipment installed, such as battery chargers, filament transformers, rectifiers, etc., adds not a little to the total of the bill.

A condition of this sort is encouraging to the lighting and power companies and should be carefully fostered. Furthermore, the public utility company can supply the broadcast material from its own studio, especially installed for that purpose. The advantages of such a procedure are manifold, both to the power company and to the consumer. From the consumer's viewpoint, he is no longer troubled by outside stations interfering with his program. He need no longer worry about not being able to pick up a particular station, for the energy supply is ample to operate his set at all times. The labor and trouble of maintaining an outdoor antenna for reception purposes is also avoided. The cost and maintenance of a storage battery may also be side-stepped by utilizing the power available in the line itself.

From the power company's viewpoint, a considerable additional revenue is practically
(Continued on page 817)

TRANSFORMER

This Will Give to the Reader a Good Idea as to How the System of Wired Radio is Carried Out. The High Frequency Waves From the Transmitter are Fed on to the Power Lines and Picked Up by the Subscribers in Their Homes.

HIGH TENSION LINE

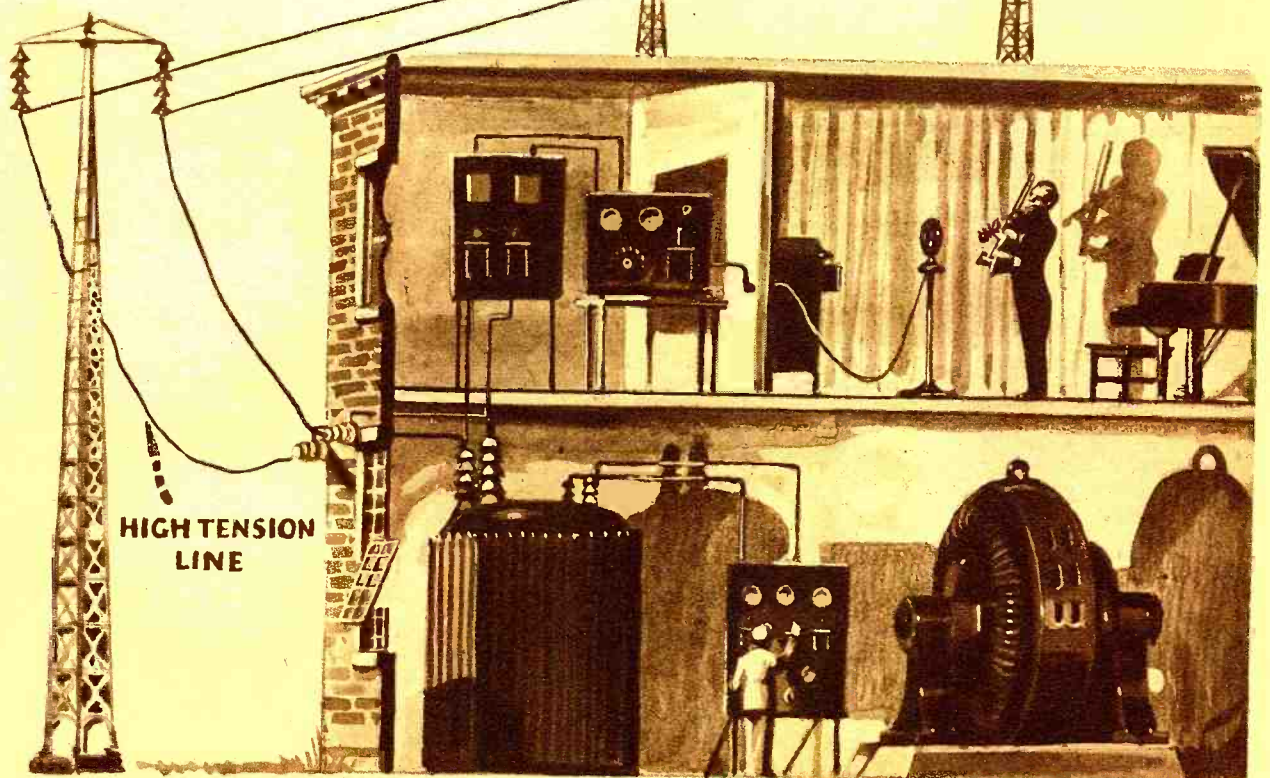



THIS Department is open to all readers. It matters not whether subscribers or not. All photos are judged for best arrangement and efficiency of the apparatus, neatness of connections and general appearance. In order to increase the interest in this department, we prefer to publish photographs of stations accompanied by a picture of the owner.

We prefer dark photos to light ones. The prize winning pictures must be on prints not smaller than 5 x 7". We cannot reproduce pictures smaller than 3½ x 3½". All pictures must bear name and address written in ink on the back. A letter of not less than 100 words giving full description of the station aerial equipment, etc., must accompany the pictures.

PRIZES: One first monthly prize of \$5.00. All other pictures will be paid for at the rate of \$2.00 each.

Station 5EK, Memphis, Tenn.

This Month's Prize Winner

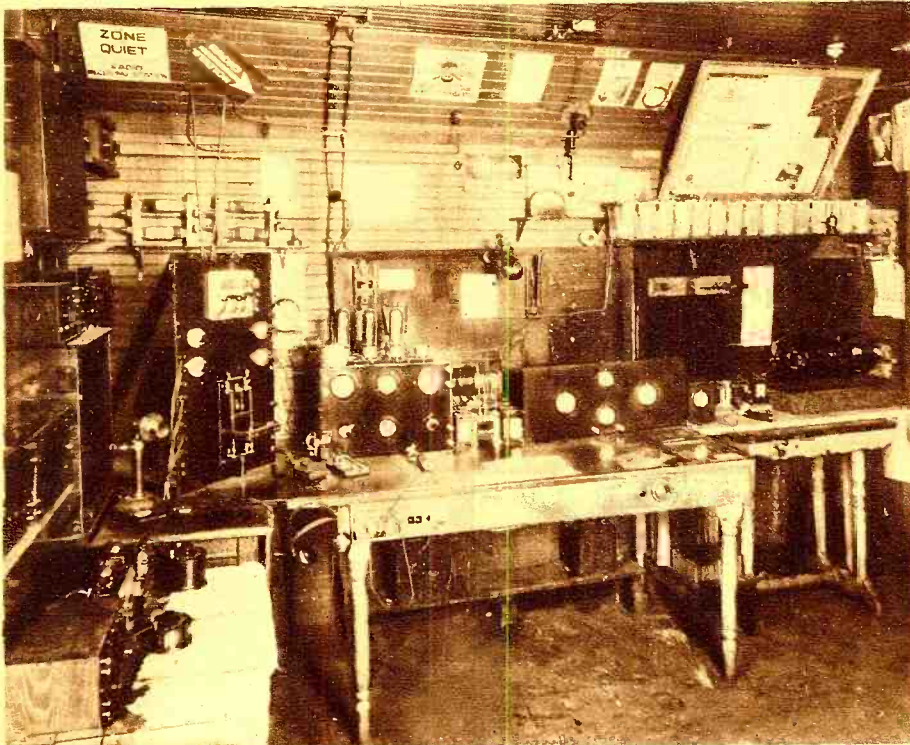

This is a "Spark Cured Ham Station." A 100-Watt C.W. Set is Used Entirely, and Excellent Work Has Been Accomplished with It. Rectified A.C. is Used on the Plates of the 50-Watters.

THIS station consists of a 100-watt C.W. set using the reversed feed back circuit. Radiation on C.W. is 3 amperes and I.C.W. radiation is 2½ amperes. A Radio Corporation chopper wheel is used; this is ideal for raising DX stations. An Acme 600-watt plate transformer is used

with four 1 mfd. condensers and an Acme double choke coil for the filter system, with a 30-jar rectifier. This set is connected with No. 8 gauge copper wire buss wiring. On the right is a phone set with buzzer modulation, consisting of eight 5-watt tubes, four as oscillators, and four as modu-

lators. The plate supply for this set is a 200-watt Emerson motor generator giving 570 volts. The filter system is made of two 1 mfd. condensers and three Acme double chokes. Behind the panel are the modulation transformer, plate reactance, condensers and a Federal inductance. Jewell meters are used throughout on both sets. Under the table are mounted the filament transformers and the grid bias "B" battery, also the 6-volt storage battery for the modulation transformer. The other storage battery supplies the juice for the receiving set.

The receiving set is a Reinartz detector and three-stage amplifier. This set is very ideal for C.W.

The switchboard on the left controls both sending and receiving.

The antenna is a 4-wire cage, 80 ft. high and 75 ft. long with a cage lead in. The counterpoise is made of 12 wires on a 20 ft. spreader below the aerial and 10 ft. above ground.

WORK DONE BY 5EK ON 100 WATT CW.

Every district has been worked, 48 states, Holland, Cuba, Porto Rico, Bahama Islands. From amateurs in every province in Canada over 3,000 cards and letters have been received reporting signals of 5EK, 250 cards coming from 6th district amateurs some hearing me on a 3 ft. loop and some with either aerial or ground.

9AAP reports me 400 ft. from phones. Ships at sea 3600 miles S.W. of Panama, 2400 miles east of New York and many other ship operators at that distance.

DX on phone set was reported from 34 States; the best working distance was 9YF at Mayville, N. D., and 3TA, 3VB in Canada, 4AR at Tampa, Fla., and 1AJP all reporting modulation perfect.

DAVID GORDON BOTTO,
873 N. Manassas Street,
Memphis, Tenn.

How To Misuse Radio Abbreviations Correctly

By L. W. HATRY, 5XU

IT is the purpose of the author to help the helpless beginners as much as possible. Having passed through the broadcast stage most of you are joining the ranks of the rankest, the code fiends or hash factories. Of course, like in everything else, there is a certain procedure or manner of acting, so to speak, which identifies you as a neophyte or not; as being rank, ranker, or one of them, having reached the depths. With true benevolence (never having liked broadcasters anyway) I am herewith setting forth the true manner of acting. This treatise will no doubt be accepted by the ham world at large as a masterpiece and authority extraordinary in its field.

If you will carefully study and apply the principles as set forth herein (or unprinciples) you will no doubt be classed among the worst and may possibly hold your license a month or ten days—if you live that long.

In concordance with this mood of beneficent malevolence, I start in promptly on those much abused Q signals by giving the most used and hence, the best possible procedure. To wit:

THE Q SIGNALS

QRA—Who is it?

Ans.—It's I'm.

All amateurs just operating their trans-

mitters for the first time must carefully notice this abbreviation and commit it to memory—then forget it.

Whoever you work must be carefully told six or seven times just who you are, although twelve times will give you more practice in sending and will so thoroughly confuse the receiving op. that it will be two days before he finds his way out of the paper used in copying it and your mistakes.

The ham who has six or seven months' experience couldn't make us believe it if we should find a call book around his shack. He should always QRA everyone and then

(Continued on page 730)

Radio Station 4BY

By P. G. WATSON

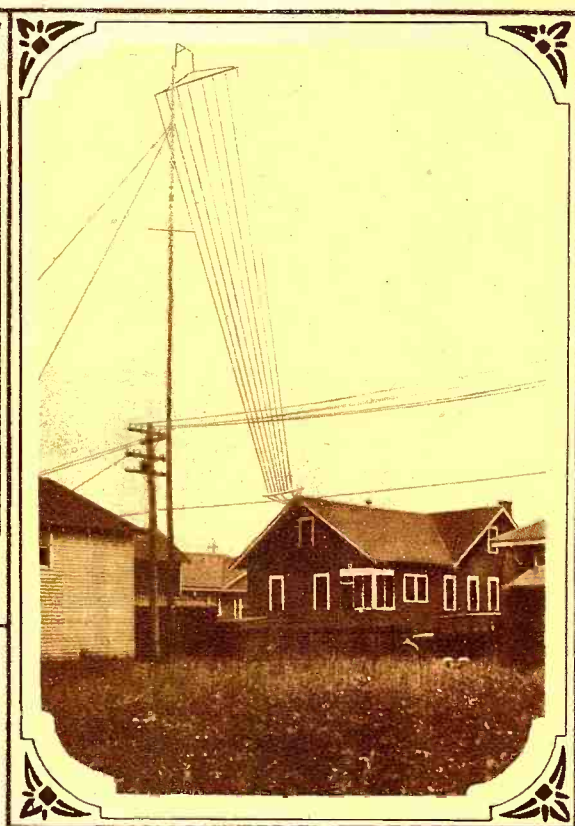
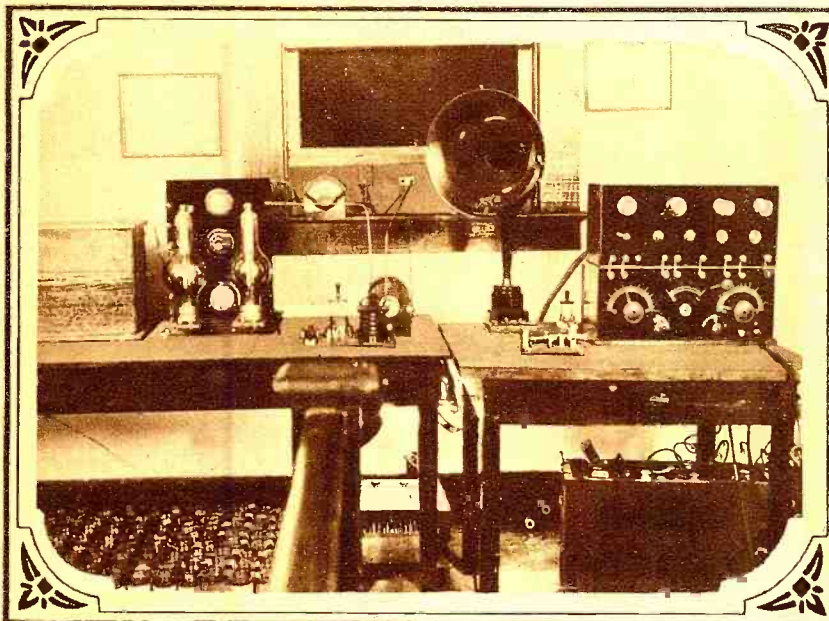

4BY is a Well-Known Station, First, Because of its Carrying Qualities, and Second, Because of the Operator's Speed. Note the "Automatic Fist" in Front of "Maggie." It Takes a Certain Amount of Diplomacy to Work One of These. Maggie, by the Way, Must Speak Loudly Where Used with the 3AF Atop the Zenith Tuner. It is Very Uncommon to See a 500-Watt C.W. Set as Compact Looking as This One. The Plate Voltage for the Bottles Passes Through a Battery of Rectifier Jars Which Can Be Seen Under the Table. 4BY's Antenna is Shown in the Right-Hand Photo.

RADIO station 4BY, owned by J. E. Hodge, of Savannah, Ga., began operation immediately after the World War with a $\frac{1}{2}$ -K.W. spark transmitter, in a much poorer location than the present station. Considerable experimenting was later done with five-watt tubes with poor results. The station was built on its present location two years ago, the ground system having been put in before the house was built, and it practically covers the whole lot. The first year's operation was with one R.C.A. 250-watt tube. A year ago this was increased to two tubes of this size. Generally speaking, good results were secured, but many difficulties were encountered, most of which have been overcome. The present installation only will be described, as it is quite impossible to take up, in the limited space allowed, all the stages of development of this station, however interesting they might be.

The receiver, a "Weagant", is a type not generally used in amateur stations due to the difficulty of construction and operation, particularly if attempting to follow a description as written up in the various radio publications. The nearest approach to it is the "Reinartz", which upon analysis is only a redesigned "Weagant" circuit, and being a single circuit receiver, falls far behind the "Weagant" receiver in operation, especially in reference to selectivity. This type of receiver is worthy of many columns, but it will have to suffice to say that the one in use at 4BY consists of the usual "Weagant" tuning elements, three stages of audio frequency amplification, and a Magnavox. It is worth mentioning, that once roughly tuned and set oscillating, it is only necessary to move one variable condenser to receive continuous wave signals from any amateur station operating on wave-lengths from 150 to 300 meters.

Possibly the most interesting feature of this station is the transmitter, which has been heard in nearly every part of the Western Hemisphere, excepting South America. The constructional details will interest those contemplating the building of a high power C.W. station, as it is in many respects much harder to perfect a station of this size than the smaller 5-watt and 50-watt stations. The "Reversed Feedback" or British Aircraft" circuit is used, and needs no description. In designing a station, the first point to consider is the source of power. This will be no small problem if an attempt is made to build a transformer by the inexperienced. However, it is not as difficult as might seem at the first glance, and is one of the relatively inexpensive items of the station. The transformer described below, as used in this station, cost \$39, including \$10 for labor, or a net cost for material of \$29. The constructional details are as follows: The iron core is proportioned as shown in the drawing, and consists of 650 pieces of iron, just as taken from an old G. E. power transformer. They were cleaned by boiling in strong lye water, dried and coated with thin shellac. The weight of the core is approximately 50 pounds. The windings are concentric, both primary and secondary being on the middle leg of the core, the secondary being directly over the primary. The primary consists of 220 turns of No. 10 D.C.C. wire tapped at the 110th turn, this arrangement being made in order that it may be operated at one K.W. from 110-volt supply or at two K.W. from a 220-volt supply. The secondary consists of 12 of 1,100 turns each, of No. 27 S.C. enamel wire. Each pie was impregnated as wound by running the wire through a basin of hot paraffin while winding, and is further insulated

by being wound with empire tape on the outside. The inside diameter of each pie is $4\frac{1}{2}$ " and is wound to a depth of $1\frac{3}{4}$ ". The secondary pies are tapped to two switches which are clearly shown in the photograph of the transformer, for the variation of voltage. This type of variation was used in preference to the primary variation on account of constructional difficulties, mainly the difficulty of tapping the No. 10 wire and bringing out the leads, with the secondary wound directly on the primary. The switches and binding posts are arranged on a small bakelite panel for convenience in operation. A wooden frame is built around the two sides of the core, and held together with bolts. This should be strongly constructed, otherwise the windings will be damaged from contact with outside objects, should the frame fail or break in some way.

The chemical rectifier consists of 200 jars, made up of ordinary drinking glasses with lead and aluminum elements, the dimensions being $1\frac{1}{4}$ " x 4", and filled with a saturated solution of ordinary borax. The solution is covered with a thin coating of oil to prevent evaporation. Considerable experimenting was done with chemically pure borax, distilled water and pure aluminum, but apparently nothing was gained over the use of "20 Mule Team" borax and commercial aluminum in hydrant water. The number of jars was not arrived at arbitrarily; the working voltage of the secondary was first determined, then an ammeter was placed in the supply line, the set disconnected leaving only the rectifier across the line, and the jars increased until the current from the line was practically negligible, showing that the rectification was practically perfect.

At the present time we are construct-

(Continued on page 738)

The Transmitter At Station 8AZ

By J. E. FETZER

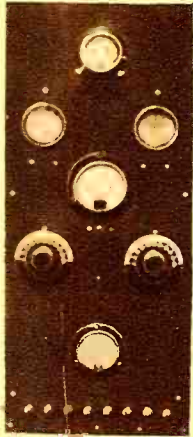
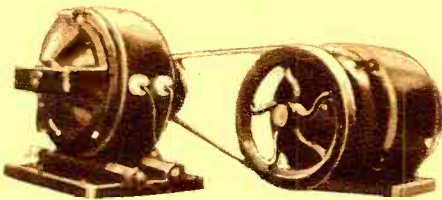

Fig. 1. Front View of the Transmitter Panel Clearly Showing the Meters and Controls. Fig. 3. The Motor-Generator That Supplies the Juice for the Plates. The Generator is a 220-Volt D.C. Motor Worked Backwards, So to Speak.



IN response to the many requests that I have received from nearly every section of the United States in the past few months, I herewith give a brief description of station 8AZ, Emmanuel Missionary College, Berrien Springs, Michigan. I wish to say at the outset that I humbly regret the fact that I am unable to write a personal answer to the scores of questions asked. Lack of time prohibits it. The writer does not intend to put out the idea that the transmitter described is a super-set or anything of the kind,—but merely give that which practical experience has brought to the surface.

After re-reading all the communications received, I have taken all the questions and tried to mold together, in the answers, enough salient details of the equipment, so as to give the reader a birds-eye view of the whole situation.

Referring to Fig. 1, some idea will be had as to the general appearance of the set. The bakelite panel is 26" high and 11" wide. The meter at the extreme top is a hot-wire ammeter. This type of meter is not recommended to those contemplating purchasing new indicators, but rather the thermo-coupled type, which will insure accuracy at all times. Just below this instrument are seen two panel bezels for the tubes. These bezels are constructed of copper screening. This material may be purchased at any hardware store. Below the peep-holes is a Jewel A. C. voltmeter. This device is used in measuring the E. M. F. on the filaments of the tubes. It reads from 0 to 15 volts. This piece of apparatus is very important, as the life of the tubes depends upon accurate voltage or rather the specified voltage (7.5) on the filament terminals. Try to use a set without this instrument and you will more than likely have a tube funeral in a short time.

The dial at the left controls a carbon pile rheostat (Bradleystat) for filament control. The regulator at the right manipulates a 23-plate variable condenser. The meter below, in center is a 0-500 milliammeter, not absolutely necessary, but convenient; in other words, get it some way if at all possible. At the bottom are located eight binding posts to which all connections are

brought from underneath the transmitter, thus making it commodious enough to make changes in connections.

Fig. 2 shows the general outlay of the apparatus. Since the first description of the set was given in the June issue of *RADIO NEWS*, two more tubes have been added, making it a 20-watter. The valves are visible at top. Below is a variable condenser and on the bottom support is the filament transformer. At the back is situated the oscillation transformer, on top of which is located the modulation transformer and a honeycomb coil, used as a radio frequency choke. Just at the bottom, on the outside of the oscillation transformer, is a grid leak.

Now for the motor-generator. Referring to Fig. 3, the motor is on the right and the generator on the left. Many questions have been asked about this generator and I think the following will answer them all. The generator is a Robbins and Myers machine, originally a 220-volt D.C. motor of the following specifications: 1/10 horsepower, speed, 1575 R.P.M., shunt wound, 24 segments on commutator. The shaft has a 2" pulley on it. The machine has not had any changes made, such as re-winding or changing field coils, etc. It simply remains the same when being used as a generator excepting that it is now a machine used to convert mechanical energy into electrical energy. It is driven by a 1/4-H.P. motor from the 110 A.C. mains. This motor has a 5" pulley on it. A good steady E.M.F. is obtained of about 500 volts. The machines are coupled as shown in Fig. 3.

Fig. 4 shows the circuit used. A circuit similar to this was first used by the British and consequently is known as the "British Aircraft" circuit. It was first described in this country by E. W. Whittier and has several names, such as "IDH" or the "Sure-fire" circuit. The antenna is connected to switch SW2. When this switch is thrown to position C, the antenna is connected to the main inductance L1, having aerial ammeter, AM in series with lead, as shown. Also

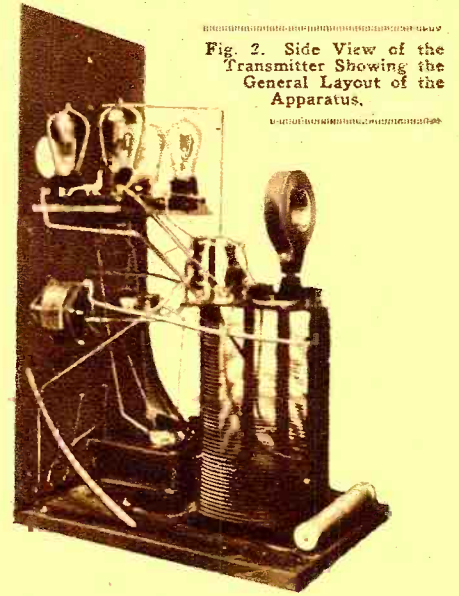

Fig. 2. Side View of the Transmitter Showing the General Layout of the Apparatus.

when this switch is in position C, the power circuit closes, lighting the filaments of the four 5-watt tubes, 1, 2, 3 and 4 through the filament transformer FT. The motor-generator, MG, is also started. When switch SW2 is thrown to position D it merely connects the aerial to the receiver; only one contact is used in this position, the other being left open. L1 has four tap-offs, namely, the aerial, already mentioned, the counterpoise CO, ground G, and the lead from plate isolation condenser C4. The purpose of the ground connection G in use with counterpoise, CO is to ground the D.C. high voltage source and to aid in redistributing the earth currents. This was necessary because of the poor physical conditions surrounding the counterpoise. Both inductances L1 and L2 were originally one large inductance of (Continued on page 736)

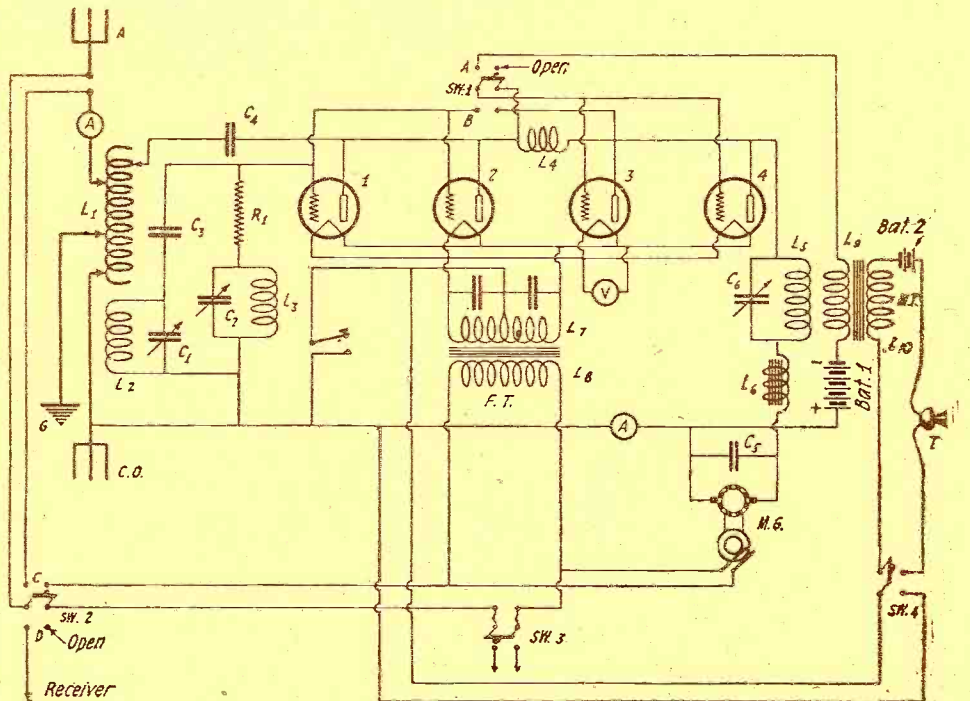
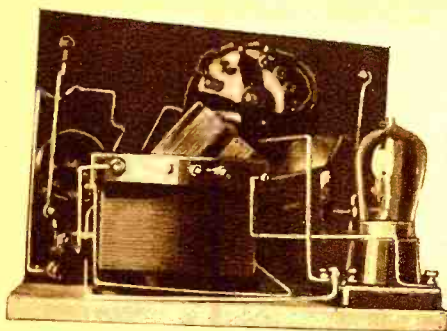

Fig. 4

The Complete Circuit Diagram of the C.W. Transmitter at 8AZ. It is so Arranged that C.W. or Phone Can Be Used at Will. Note That Both a Ground and a Counterpoise Are Used.

An Efficient Amateur Station

By BALDWIN G. SULLIVAN



Left: A Rear View of Mr. Sullivan's Single Circuit Regenerative Receiver. Right: A Front View of Both Receiver and Transmitter.

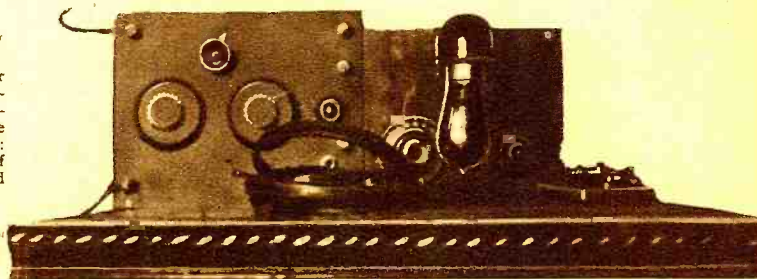

IT is the purpose of this article to guide newly licensed amateurs to build efficient stations, and to provide them with data, which, if followed out carefully, will produce maximum efficiency at minimum expense.

The author has tested the receiver and transmitter thoroughly and having compared them with all other types has found them to be efficient and simple to operate. He also has attempted in the following instructions and data to give all the particulars, constants, etc., so that nothing is left to guesswork.

RECEIVER

The receiver to be used is of the single circuit regenerative type, which has a number of advantages over either the variometer or honeycomb type. First of all, it is a known fact that amateurs are sometimes bothered by the failure of some variometer receivers to tune below 230 or 240 meters. This is a trouble that can be remedied only by the use of a variable condenser in series with the primary circuit, which adds one more tuning control.

In this set there is no trouble in getting down even to 150 meters and, using certain quantities of inductances, amateur stations may be heard over the full dial scale, where with a variometer set usually 20 or 30 degrees are the boundaries of amateurs, when tuning is more difficult. The receiver consists of a variocoupler, one 23-plate vernier variable condenser, bakelite panel, cabinet, rheostat, socket, tube and batteries. Using the circuit shown, the author at his station in New York City has logged 4BX, 5MO, 5EK, 5XK, 6ZZ and many others using one tube and a piece of No. 22 S. C. wire strung around the molding of the room as an antenna.

In assembling this set, use good, reliable apparatus and follow hook-up to the letter. Use bakelite for the panel 7" x 10" with a neat cabinet to match. I would advise Remler or Columbia coupler and a Heath 23-plate condenser with geared vernier plate also a neat, small radius, inductance switch.

Solder all connections and use either No. 16 copper or square tinned copper bus-bar wire for connections and black spaghetti tubing for insulation. As to batteries, use a reliable make "A" battery and for plate "A" Burgess 22½ volt is recommended. Use a UV-200 as a detector, as this is about the best one licensed for use in this country. If the rotor of the coupler, which is used in the plate circuit as a tickler, is equipped with stopping pins which limit its rotation to 180 degrees, the connections may have to be reversed if the circuit does not oscillate.

Careful control of the filament voltage is an essential; light the filament to that point where the set oscillates with a soft hiss or mushy sound. If the oscillation announces itself with a loud click, then either filament or plate voltage is too high and this form of oscillation is not to be desired.

For C. W. stations the vernier plate is a

boon because on the average set when the hands are taken away from dials to copy a message, the C. W. stations become detuned. This is due to capacity effect of body and hands and is very annoying.

Use Baldwin or W. E. phones. It is of interest to note that 6ZY recently broke a world's record for long distance receiving while using this circuit.

TRANSMITTER

The transmitter is of the continuous wave type, using C. W., I. C. W. or phone, and its reliable range on C. W. is about 300 miles, although much further distances can be worked under good conditions. The apparatus used in this transmitter is as follows: One UV-202 power tube, one 43-plate variable condenser, one standard make

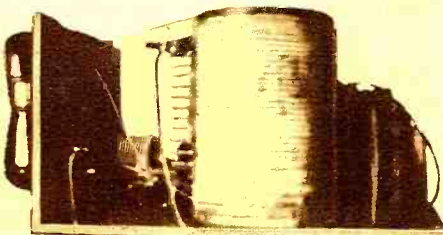

A Rear View of the 5-Watt C.W. Transmitter Showing Disposition of the Apparatus.

socket, one transmitting grid leak 5-watt set size, one power tube rheostat, one key, one microphone, one hot wire ammeter (0-3), four or five 2-M. F. filter condensers and one 100-watt, 550-volt power transformer equipped with filament heating secondary. The remainder of the apparatus, namely, the inductances, electrolytic rectifier and choke coils, may be home made.

The circuit used is the grid tickler, also known as the 1 D. H. circuit or reverse feedback. This circuit was selected because of its power to oscillate on 200 meters without any trouble, because many of the other circuits will not oscillate on 200 meters unless a series condenser is used, and this cuts down radiation.

Two inductances must be made, one of which fits inside of the other. The primary

inductance consists of about 25 turns of No. 12 or No. 14 bare copper wire wound on a tube 5" in diameter. The other inductance consists of 15 turns on a 4" tube. These turns should be spaced about ¼" apart. An easy way of spacing is to wind some heavy twine between the wire turns. Connections are made to the primary inductance by means of Eureka clips. Be sure that the grid coil turns are running in an opposite direction to the turns on the primary inductance.

The electrolytic rectifier consists of 10 jars each, with one lead and one aluminum plate, using five jars on a side. For the solution, use 20-Mule Team Borax and water, making a saturated solution by boiling. Be sure to take out any solid matter which is not absorbed by the water. The chokes may be wound on a laminated core or a core of iron wires. The wire should be fairly heavy and a good number of turns used in order to obtain a high A. C. impedance and a low D. C. resistance. One D. L.-500 will serve as a radio frequency choke. Follow the diagram closely and tune with condenser and taps on primary inductance, also altering the position of the grid coil until maximum reading on the meter is reached. Find wavelength either by wavemeter or tests with other stations. Place the tuning instruments on a 7 x 10 bakelite panel and place next to the receiver so that the whole presents a symmetrical appearance. Use an anti-capacity switch for antenna change-over and wire this to also control filaments and plate voltages on receiver and transmitter.

ANTENNA

For reliable work much depends upon a good, well insulated and low resistance antenna and the type that should be used is the inverted "L" cage. It is a tendency of most amateurs to try to make their antenna as long as possible, but this is not advisable. I strongly recommend an aerial whose total leads are no more than 100'; in other words, if the lead-in is 40', then make the flat top 60'. Use two hoops about 1½' in diameter for flat top which contains six wires spaced evenly and use 6" hoops for lead-in, which should also have six wires. Using an antenna of this type and length will enable you

(Continued on page 816)

Circuit of the 5-Watt Transmitter. AM, Hot Wire Meter; L1, Antenna Inductance; L2, Grid Coil; L3-L4, Iron Core 1½ Henry Chokes; C1, .001MF; C2, .001MF; C3, .001 MF; C4-C5-C6, 1 MF Condenser; C7, .001 MF; R1, Filament Rheostat; R2, 10,000 Ohms.

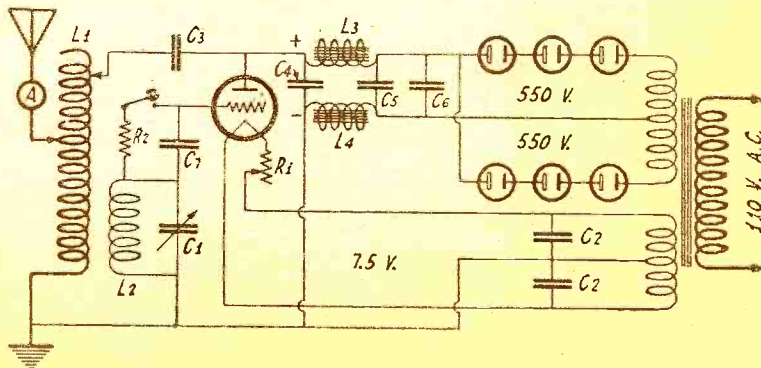

Fixin' Up the Shack

By HOWARD S. PYLE, A. M. I. R. E.

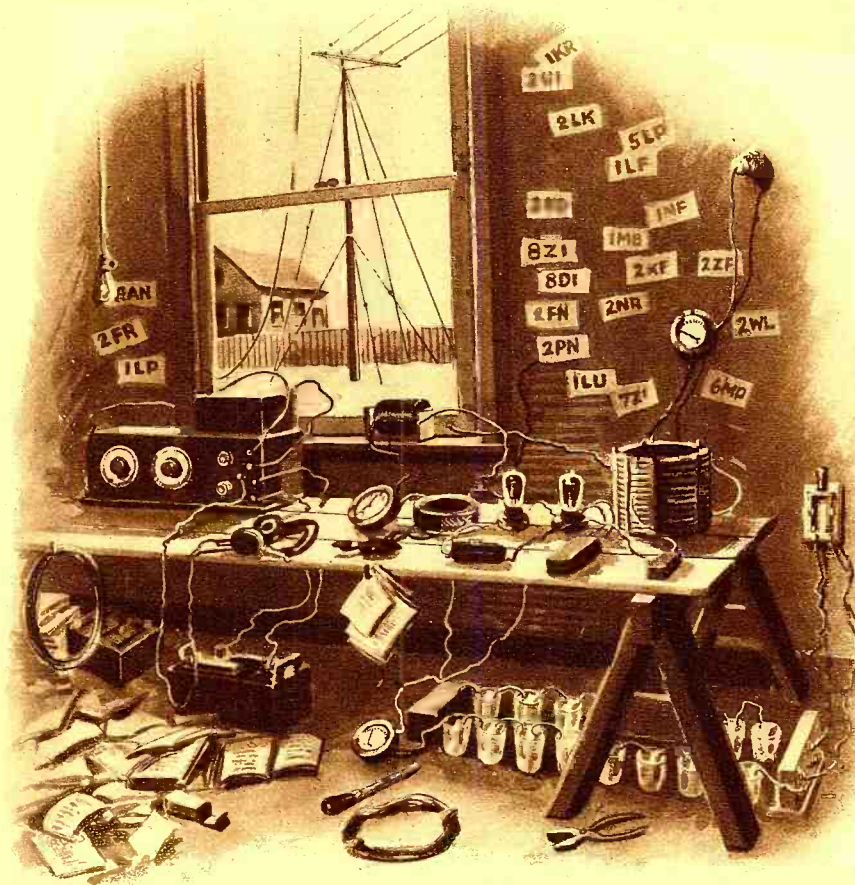

HOWARD S. PYLE is not only a well-known and old-time "Radio Amateur," but he is today Assistant Inspector of the Eighth Radio District. In this position, Mr. Pyle unquestionably knows what he is talking about because in his monthly rounds, performing his duties, he not only sees dozens, but hundreds of radio amateur shacks.

Mr. Pyle is perfectly right when he takes us to task for not tidying up. Unfortunately, we radio amateurs have been, in the past, so much taken up with our work that we pay little attention to appearances. When the outside world peeks into our shack and judges us and our work by the actual appearance of the shack, little doubt remains as to why we are so unpopular with the public, and the BCL's. Let us get busy and clean up. We need it badly. Let us show the world that radio amateurs are up-to-date not only in spirit and performance, but in the appearance of their shacks as well.

—EDITOR.

And, too, it's probably next to impossible to obtain anything but a blurred vision through the panes of glass. It'll only take a few minutes with a damp cloth to remedy this unsightly condition. A simple curtain on a string across the sash will take away the cheerless appearance of the average station and it's not a sign of femininity in the station owner either!

You do most of your DX work in the winter. Unless your set is in the house, you've probably installed a small wood

(Continued on page 802)

FELLOWS, here are a few thoughts that will strike home to most of you, but in order to get the full effect, take this issue of RADIO NEWS right into your station, close the door, and read it alone! From time to time refer to your equipment, and upon completion of your reading, get busy!

First, can you explain just why you use a rickety old table or a makeshift bench for an operating desk, when two smooth boards and a few nails, with a couple of odd sticks for trim, offer all the necessary material for a neat, substantial bench? Finish this off with a few coats of grey porch paint—you'll probably find a half can full in the basement—and you've eliminated the eyesore that the old table really was.

Now take a long, earnest look at the walls of your shack. You fellows with your sets in one of the rooms of the house, probably have a neat plastered wall, but in the attic, garage or out-building, I'll bet the cobwebby old rafters still predominate. It won't cost more than a very few cents to slap some white paint all around, with a coat of something darker from the floor to a point about four feet up. You can even whitewash the walls with a 100 per cent gain in appearance over the old studding. Wall board is perhaps the best bet, but a bit more costly. Anyway, somehow, fix 'em up!

Your flooring too, must come in for its share. Paint will again do the trick or perhaps a discarded rug or piece of linoleum from the house will add just the touch you need.

How about your windows? If you're out of the house, it's a safe bet that the windows of your radio shack furnish ideal corners for several families of spiders to winter in.

Mr. Pyle Brings Out Some Vital Points in This Article That Every Amateur Should Heed. These Two Sketches Tell You at a Glance What He Means and What We Mean. Think it Over.

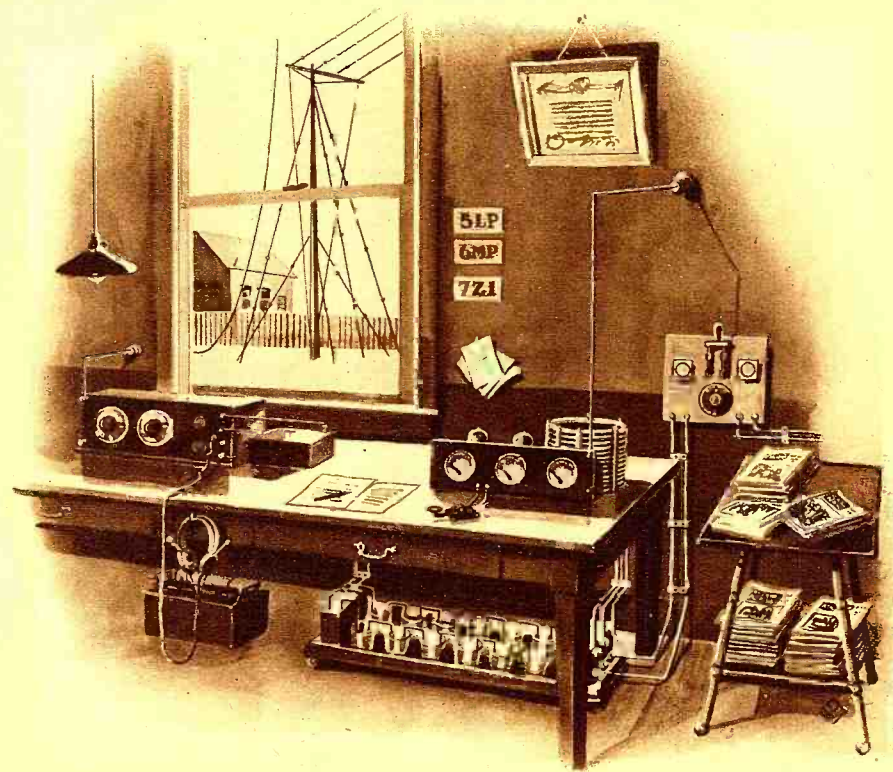

C. W. and Radiophone Transmitters

By L. R. FELDER

Part III

IN transmitters of the order of 5-watt power output, as considered in previous articles, the filament supply and plate voltage source could be relatively easily obtained. Thus the filament supply could be the usual storage battery, and plate voltage source might be either a bank of large "B" batteries, or the line voltage or small motor generator. In the case of the 50-watt transmitters or higher powered sets,

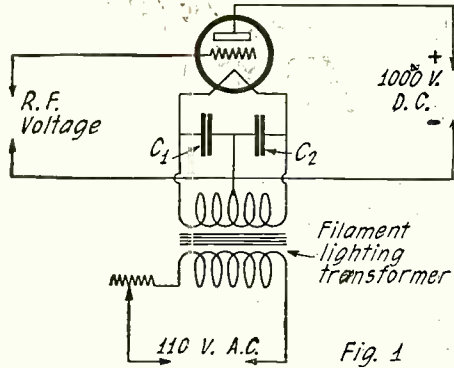

The Proper Way to Connect a Filament Heating Transformer for a C.W. Set.

these alternatives are not so readily available. In the first place when we consider the filament supply we immediately see that the storage battery is not a convenient or economical source of supply. Filament currents get to be as high as 14 amperes or over, and when currents of this order of magnitude are used it is time to get another source of power which would not have to be looked after as often and as carefully as the storage battery. Alternating current is then the only logical solution. A transformer should be used for stepping down the A.C. line voltage to the voltage necessary for the filaments. The maximum current used and the source of supply would always be available by simply connecting to the lighting line.

USE OF FILAMENT TRANSFORMERS

The filament transformer to be used depends upon the number of tubes you are using, the power of the tubes, and the current the filament draws. The transformers on the market are designed for a wide range of powers. Thus some manufacturers will deliver from 9 to 26 amperes at 8 to 12 volts. This range is sufficient to take in powers represented by 5-watt tubes, to four 50-watt tubes or one 200-watt tube. Where it is necessary to vary the voltage supply to the filaments this can be readily accomplished on the new filament transformers recently put on the market, which have taps for varying the voltage. In connecting up the filament transformer care should be taken that the grid and plate return are connected to the center tap of the filament transformer. When these filament lighting transformers are purchased it will be observed that they have three taps in the secondary or low side. The middle tap is connected to the exact center of the secondary winding. This is the tap to which grid and plate are connected as in Fig. 1. This connection scheme accomplishes two purposes. First, it equalizes the electron current in both sides of the filament by bringing the plate return to the center of the transformer winding which is equivalent to the center of the filament. Secondly, it connects the grid to a point of the winding which does not change its potential alternately from plus to minus, thus avoiding

the superposition of alternating current voltage from the supply on the grid. The first prolongs the life of the filament by preventing excess current flowing in one side of the filament, this excess being due to the addition of the electron plate current. The second prevents the appearance of a disagreeable 60-cycle hum being transmitted from filament to grid. In order to accurately control the filament voltage it may be necessary to use rheostats in the transformer circuit. It is not desirable to use rheostats in the secondary or low side of the transformer because the rheostats would have to be built to carry the very heavy filament current. It is much easier to control the voltage by means of rheostats in the primary or high side where the current is much lower. It will be found that some of the transformers on the market have the rheostat on the transformer. The connection for this controlling rheostat is shown in Fig. 1. A voltmeter should be used for indicating the filament terminal voltage, rather than an ammeter for current, for the reason given in the last article of this series (see November issue of RADIO NEWS). Still another precaution which should be observed in the use of filament transformers is the use of radio frequency by pass condensers across the secondary winding. These condensers are shown in Fig. 1, C1 and C2, and each should be at least $\frac{1}{2}$ microfarad in capacity. They provide a low impedance path for any high frequency currents which may flow that way.

PLATE SUPPLY

For higher powered sets the problem of plate supply is one of securing the necessary high voltage, which in this case comes to voltages between 750 and 2,000 volts D.C. Motor-generators are not easily or cheaply obtained for such high voltages and the next best solution of the problem is to use rectified A.C. For this purpose it is necessary to use rectifier tubes, one tube if only half-wave rectification is used, two tubes if full-wave rectification is used. In connection with the Kenetrons it is necessary to employ a step-up transformer for raising the line A.C. to the required voltage, and also a filter circuit for securing a straight line D.C. voltage after rectification by the Kenetrons. The circuit for obtaining the necessary rectified voltage is given in detail in Fig. 2.

The Kenetron is represented by K, the filament being lighted by the regular filament transformer which has a separate winding on it for the rectifier tubes. Due

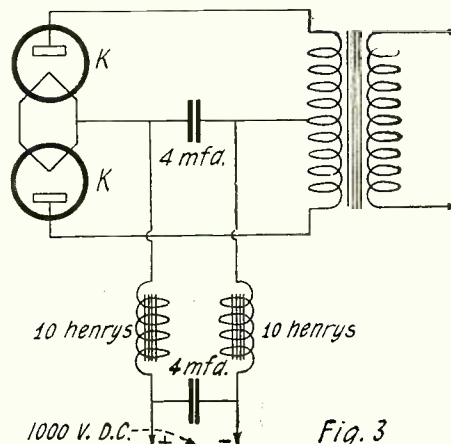

Full Wave Rectifier Circuit for Obtaining High Voltage D.C. from A.C. for a C.W. Transmitter.

to the manner of connecting the rectified A.C. to the plates of the oscillator tubes it is essential that a separate filament winding be used for the rectifier tubes, as otherwise the high voltage D.C. will be short circuited. The filament transformers mentioned above may be obtained with this separate winding on, or separate rectifier filament transformers may be purchased. The plate transformer must be wound to step up

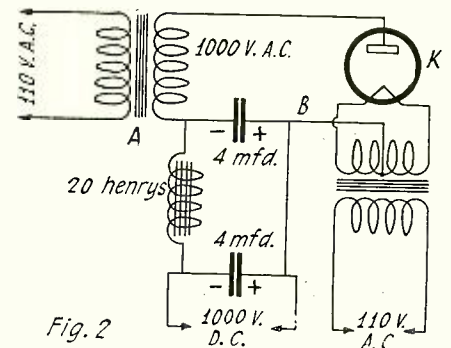

Half Wave Rectifier Showing the Principle of Operation of a Kenetron Tube.

the voltage to the value required for the plates of the oscillator tubes. In the case of the half-wave rectifier the high voltage side must be wound for the exact plate voltage required, whereas in the case of the full-wave rectifier it must be wound for double this voltage, for half the transformer works on one-half the wave, while the other half works on the other half of the A.C. wave, as will be seen in Fig. 3, which represents the full-wave rectifier, as against Fig. 2, which represents the half-wave rectifier. These transformers are likewise best purchased ready made, as the manufacturers of them have designed them specifically for the purpose here mentioned. The prices of these are very reasonable and those who are interested in the construction of a set of this size will be satisfied to go to this extra expense.

There is a company that makes a combination transformer which combines plate and filament transformers on one core. Although this may be a trifle less expensive than two transformers, best operation and efficiency will be secured if separate transformers are used for filament and plate. The reason for this is that any variation in the primary of the transformer, as for example varying the current taken by the tube filaments, will influence the potentials not only on the filament winding but also in the plate winding, thus making the adjustments inflexible. It is preferable to be able to adjust filaments and plate constants independently of one another and this may only be secured by the use of separate transformers for plate and filaments.

When the alternating current is applied to the plates of the rectifier tubes plate current flows in only one direction due to the unilateral conductivity of the tube. As a result a direct voltage appears between the points A and B, across which a condenser is connected. This direct voltage has A.C. ripples superimposed on it and these must be filtered out to secure a straight line D.C. voltage. This is accomplished by a filter circuit. A filter circuit consists essentially of a combination of inductances and condensers connected in such a manner as to weed

(Continued on page 764)

The Dope On the Second National A.R.R.L. Convention

QST-ed de L. W. HATRY, 5XU.

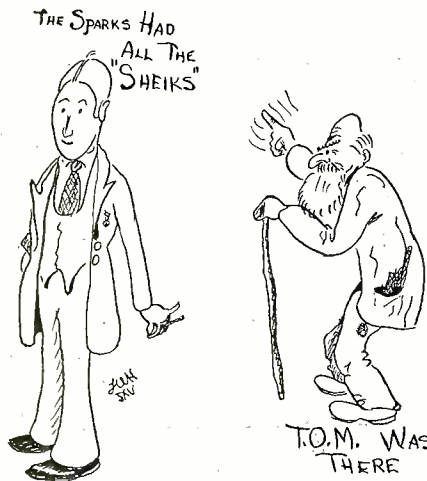

It was the Greatest Gathering of Spark and C.W. Hams Yet. T.O.M. Had a Few Choice Remarks for the "Young Squirt."

came a happy, hammy get-together for the cordial, boisterous crowd. The bedlam that reigned started with a few who brought whistles; code flew right and left. Deloy, as soon as the gang realized that he was really there in person, was swamped with autograph hunters, impatient and rapacious. Meanwhile those without whistles scoured the shops in fruitful effort. Words are powerless to describe the pleasure of these friends of the air becoming friends in reality.

THE SECOND DAY

On the twelfth things really started. All morning the gang hammed, whistled, sang, groaned, and hummed code. They had an even better get-together than the day before, for friendships had been formed. 8ZD and 3UN showed up with auto horns and batteries so that soon enough noise was being made with them to rival the worst of QRM nights. A bunch were taking pictures of one another and as many others as they could get outside into the coolness and sunshine.



The Loop Contest Nearly started a Riot on the Streets of Chicago. The Natives no Doubt Thought That the Inmates of Some Nut Factory Had Been Set Loose for an Airing.

GEE! But it was great! You birds who missed this, the greatest of ham get-togethers, have missed the best half of your lives. Matty, KB, Kruse, Schnell, 6KA, 2FP, 1ZE, and others were there with bells on. And, say, French 8AB, Leon Deloy, came clean across the big pond to say hello to the gang: he said it, too, and said it right. I could go on and ruin several pages with a perfectly good list of celebrities of our world, if I tried to list the bunch. The ones, the twos, the threes, the fours, the fives, the two sixes, the three sevens, the numberless eights, and the uncountable nines were all shaking hands hamily, chumily, happily, gladly. The Canadians were there in force and their manager made an apt and pleasant talk on their relation to our own A.R.R.L.—but, I am getting ahead of myself.

THE FIRST DAY

The eleventh of September was not meant to be the real first day, but merely registration time: we fooled the plans though; when that gang started registering and seeing fellows, for the first time, whom they had talked with, the matter was settled. Everyone had to meet everyone else so the day be-

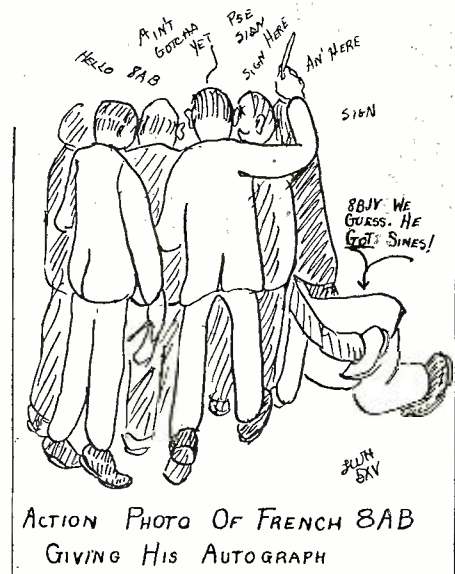

French 8AB Had His Troubles When the Gang Ran Him for His Autograph. The QRM Was Terrific.

(Chi is cold compared to Texas in September). But the time came when everyone was ripe for anything, so that when the athletic contests were announced for the afternoon a good-sized gang took part. Several short races were run, a three-legged race, a wheel-barrow race (both 5XV ops. bit the dust), and a skipping race livened things up and gave some hearty laughs to the by-standers. Buzzes and whistles of Hi resounded all around. A tug of war between C.W. and spark was the premier event though, and was won by the C.W. gang who dragged the sparks unmercifully. (Just retribution.) As C.W. won, the sparks were given the addresses of stores where they might purchase C.W. apparatus. Prizes of value were to be given to the winners who held tickets as awards, on the last night.

After the athletic contests the gang split up into small crowds to get cleaned up and to prepare for the banquet which was to be the big event that night.

THE BANQUET

We, speaking for all who had been there previously, thought we had seen a lot of hams until we saw the gang at the Hotel LaSalle. GEE!! Everyone must have been there! There were at least 500 present. Everyone had whistles and was calling everyone else. Pandemonium reigned. A ham orchestra played and they lived up to the amateur rep, as they made a darn good job of it. Song parodies suitable to the occasion were sung. When the feed was served the bunch became quiet, to a certain extent, as they did justice to the excellent feed that the Chicago committee had arranged. Everyone had a good time too, for hilarity was everywhere. Of course we had our speakers and Matty of 9ZN fame introduced and slandered them all indiscriminately.

One of the important and highly entertaining speakers of the evening was the famous candidate for Congress, Andy Gump, who gave us a campaign speech that made everyone choke with laughter. I'll bet he carries the A.R.R.L. in the next election.

He was followed by Mr. Greenleaf of the Navy who gave a real ham talk and won much applause. All were glad to have heard him. Supervisor of Radio, Edwards, of the Eighth District, yes, the radio inspector—was next called upon, but proved

(Continued on page 807)



"Heard But Not Seen Often" in the Amateur Field. These Boys Gave the Gang Straight Dope on Everything From Antennae to Rectifiers and the Majority Went Home With Crammed Note Books and Heads Full of New Ideas to Pull on the Old Set.

Canadian Station 9BP Reaches Arctic

By JACK BARNESLEY

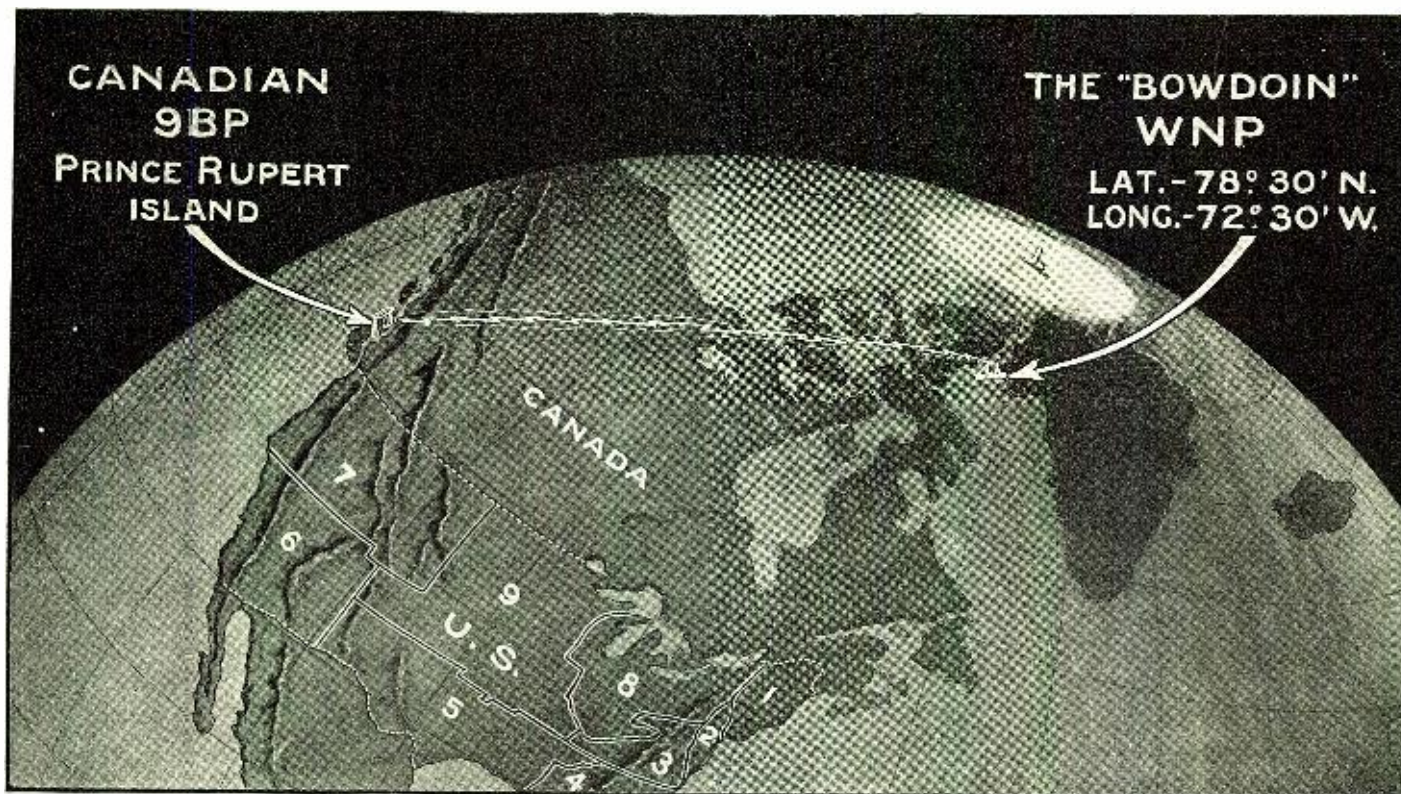

9BP is the Only Station That Has Been in Communication With the "Bowdoin" Since They Have Gone Into Winter Quarters at Etah, Greenland. Night After Night They Bridge the 3,200 Miles Between Them and Exchange Messages and News.

PROBABLY there are unknown good reasons why I was able to be the first amateur station to break through to the MacMillan expedition aboard the schooner *Bowdoin* on the coast of Greenland, but it seems rather odd that although Donald H. Mix, the operator who was chosen to accompany the expedition has heard hundreds of amateur radio stations in all parts of the United States and Canada, none of them have been able to pick him up and communicate with him.

It was on September 7 that I first got into communication with Mix at his station, in winter quarters, Refuge Harbor, ten miles north of Etah, North Greenland, Latitude 78.30 north, Longitude 72.30 west which Dr. MacMillan, commander of the expedition, told Operator Mix was about 3,200 miles from here.

APPARATUS USED AT 9BP

I am located at Prince Rupert, British Columbia at the Pacific terminus of the Canadian National Railways about 500 miles north of Vancouver, B. C. and 100 miles south of Ketchikan, Alaska. My transmitter is of the vacuum tube type, using two 50-watt tubes in a self-rectifying circuit. My receiver is a three-circuit regenerative with audio-frequency amplification only, similar to the receivers used by hundreds of other amateurs, yet while I have worked with the *Bowdoin* dozens of times these other stations do not seem to have been able to pick him up once although he has heard 486 American, 14 Canadians and one station in Mexico.

FLASHES NEWS TO THE "BOWDOIN"

While my station is not as well equipped as many other amateur stations, I seem to have been lucky in establishing almost regular communication with the *Bowdoin* in North Greenland. Possibly there is less interference from other amateur stations

here than in other parts of the country. At any rate the *Bowdoin* signals here have been loud at times and I have found no difficulty in taking many messages for relay and also in copying about 600 words of press for the New York World, together with the list of amateur stations heard by Mix from July 28 to September 20. I have also been giving the expedition the news of the day from time to time and through me they heard the first news of the Japanese earthquake disaster, and of Jack Dempsey's victory over Firpo. Mr. Mix advised that he has been unable to get any of the press transmitted by the high power station at Annapolis, on account of only having a single circuit long wave tuner and the fact that high power European stations are drowning the press messages.

BOTH WORK UNDER ADVERSE CONDITIONS

Regular communication here is broken occasionally by static and also by interference from the local Naval Station (VAJ). No doubt Mix is free from local interference, being a long way from the nearest radio station, but he says that static is very bad at Refuge Harbor practically every night, so that it can be easily realized that the signals he has been receiving must be loud in order for him to read them.

The local radio station on Digby Island is busy a good part of the time up to midnight so that it is generally after this time when I have been able to get the messages, etc., from the *Bowdoin*. As they are working on Eastern Standard time this means that it is three in the morning with Mix before we begin to communicate. While the local station is working, it is impossible for me to receive from the expedition, as they drown out all signals. Many times we have had to stand by for a short time awaiting clear air. The Digby station is only about two miles away and has a seven K.W. spark

transmitter so that radio fans everywhere will appreciate what this interference means, even though the wave-length is quite a bit longer.

Announcement was made some time ago that a modern continuous wave transmitter would be installed at Digby Island to replace the present spark apparatus, but governments are slow to act and meantime all amateur stations, as well as those interested in receiving the broadcasts, are materially inconvenienced by the old-fashioned transmitting systems generally used by the coast and ship stations.

Amateur radio fans will appreciate how pleased I was when I got a reply to my call (to WNP) about midnight on September 7, and realized that I was spanning the great wastes of the Arctic, later learning that my station was the first to successfully communicate with these hardy explorers after they went north of Disco Island; the first station of all the thousands in the United States and Canada, even though many of them had prearranged working schedules with Mix, which, he has advised, so far he has been unable to keep.

Stations which had a prearranged schedule, and others, were getting anxious over what they considered to be the continuous silence of the *Bowdoin*, and in order to increase the vigilance of amateur stations the Chicago Radio Laboratory, which installed the radio apparatus on the schooner, offered a duplicate of the *Bowdoin's* receiving apparatus to the first amateur in the United States or Canada communicating successfully with the expedition. This set I have won and Mix has advised the Chicago Laboratory through me to this effect.

Mix tells me that the station is still located aboard the *Bowdoin* and that, although some of the food and supplies have

(Continued on page 826)

Eliminating Body Capacity

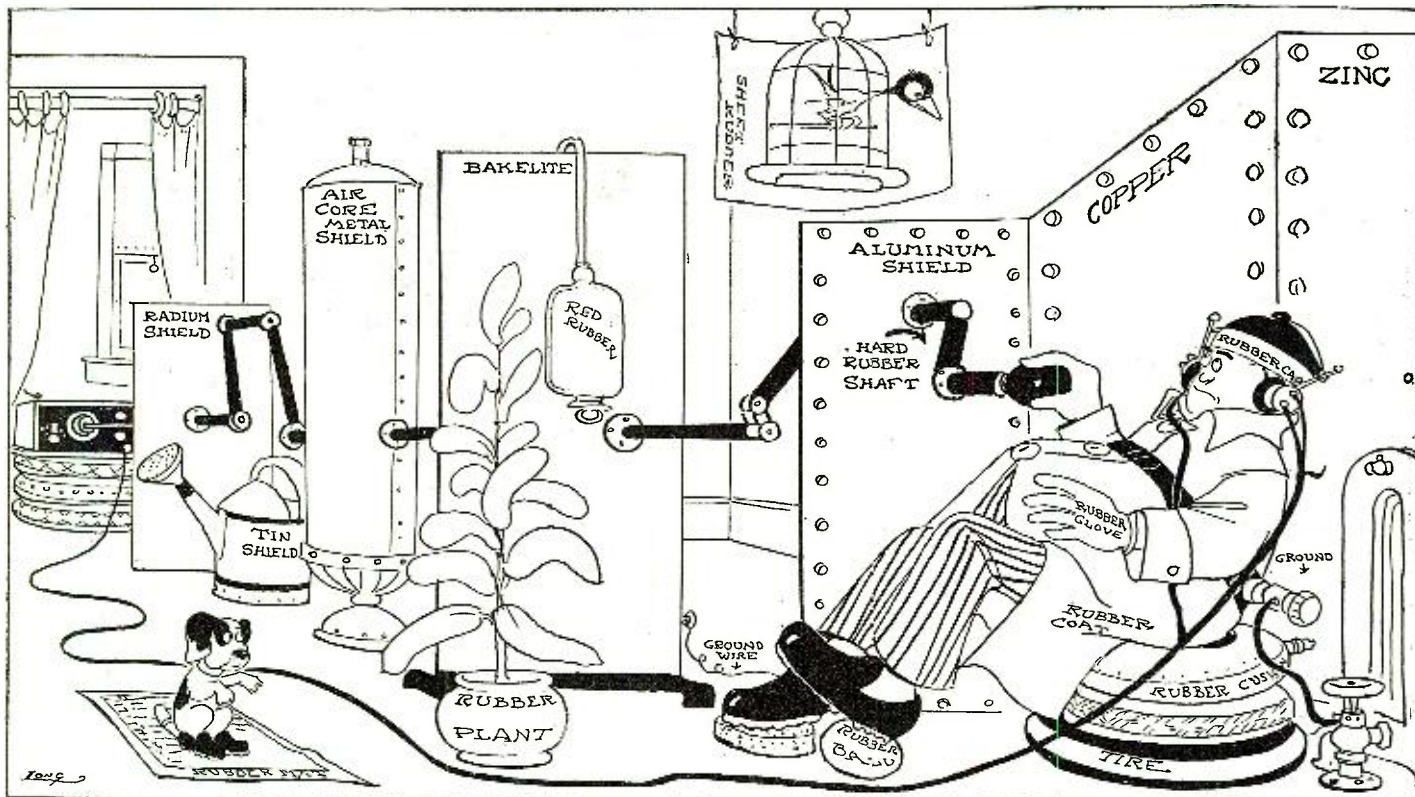

First Procure a Lot of Second-Hand Auto Tires for Seating the Receiving Set. Set the Receiver on the Tires at a Respectable Distance Away. Try Varying the Distance in Relation to the Size of Your Body, and Also Try to be Respectable. Now Sit Down on an Air Filled Rubber Cushion, Near a Radiator and Ground Your Body Circuit on the Radiator. Grasp the Rubber Nipple on the Hard-Rubber Shaft Which Must Be Seated in Metal Shields of Various Capacities. Now—being Careful to Shield the Dog and the Canary Bird—Turn the Knob and Dial. Listen! There She Comes Pounding In!

Duplex Reception By R. E. SABIN

A FEW months ago there appeared in the columns of RADIO NEWS an account of the appropriation of an aerial by some miscreant who lived in an apartment above the radio fan in question. The results were both amusing and annoying, depending upon one's point of view, but they could hardly be called satisfactory in any case. The writer has it upon good authority that this was an actual occurrence that took place up near 125th Street in New York. Of course the real interference between the two sets was due to the mutual detuning effect of one upon the other.

The problem of the simultaneous operation of two or more sets upon one aerial, and that without interference, has been a matter of idle speculation on the part of

the writer for some time. With the advent into the broadcast reception field, of the Reinartz tuner and all its myriad variations, a way to the solution of this problem has been indicated. The partial tuning of the aerial circuits of these sets has, however, militated seriously against their satisfactory operation when connected to the same antenna.

Recently there has been introduced a radically new and different tuner in which the aerial circuit remains untuned. In view of this development the problem presents itself in a much simpler light. Here we have a circuit containing no tuning capacity or inductance, in which case we may conceive that the sets in question act as wave traps inductively coupled to the aerial, each set absorbing the impulses of the frequency to which the tuning units are adjusted. At first blush it would seem that connecting sets in either series or parallel would make little difference in their operation; but, such is not the case, as closer analysis will show and subsequent experiments prove.

So, following somewhat closely a circuit recently recommended by one of the most up-to-date radio manufacturers, the writer made two sets. One of these was a single tube outfit using one WD-12 tube, while the other employed a UV-200 for detection and two UV-201's as amplifiers operating a loud speaker. These sets were connected in series. The single tube set in its cabinet was placed directly on top of the three-tube set. The aerial, an inverted L, consisting of two parallel wires each 75' long and 6' apart with a 35' lead-in, was connected to the single tube set. From the ground binding post a short lead was connected to the aerial post of the three-tube set and the ground

of this set was connected in the usual manner. Much to the writer's delight the sets operated absolutely independently of each other. While WEAF was booming in on the loud speaker one could, at will, bring in either WJZ or WOR on the headphones with the other set. In fact, it was perfectly easy to get a combination of any two at pleasure. However, when one tried to get the same station on both sets at the same time, it was found that the set which was tuned the more closely, received the signals at the expense of the other. Ordinarily when these sets were used singly they were not particularly sensitive to body capacity but when connected in tandem and tuned to as

(Continued on page 803)

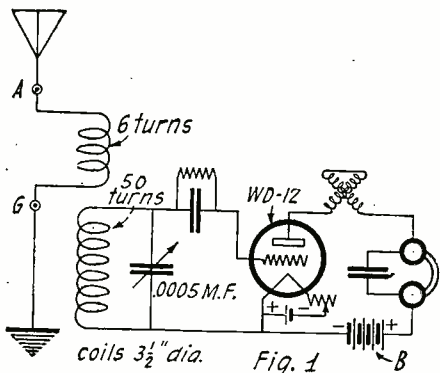

The Receiver Is Coupled to the Antenna Circuit Through an Untuned Primary Coil. Thus the Antenna Circuit is More or Less Aperiodic.

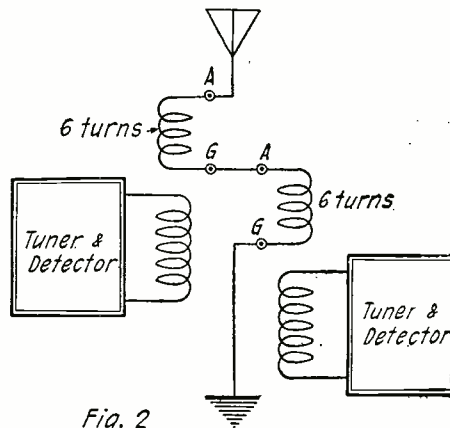

Two Sets Can Be Coupled to the Same Antenna System and Each Set Receive a Different Station Without Interfering With the Other.

Simplifying Amplifier Construction

By F. M. HOLBROOK, 2CNS

THE pleasure of experimenting with several stages of radio frequency or with various other circuits requiring a number of tubes, is greatly enhanced by simplification of the assembly work.

In the accompanying photographs and diagrams is shown the method employed by the writer for quickly and compactly assembling four Cutler Hammer filament rheostats and three potentiometers. The metal frame of each of these seven instruments is secured by a machine screw to a brass bus-bar $12\frac{1}{2}'' \times \frac{1}{2}'' \times \frac{3}{8}''$. The four rheostats constitute the lower row and the three potentiometers form the upper row. The bus-bar thus becomes the frame terminal of each instrument and is connected to the negative side of the six-volt filament battery through the "A" battery switch. This switch being of the push-pull type as used on automobile dash was readily bolted by one of its terminal screws, the other receiving the lead to the "A" Battery. The importance and comfort of such a switch in the "A" battery circuit cannot be over-estimated.

The four rheostats were bolted, each by a single machine screw, to a horizontal bakelite floor panel $13'' \times 6'' \times \frac{1}{8}''$ on which

A Front View of the Radio Frequency Receiver Constructed by Mr. Holbrook. The Disposition of units Allows for Short Direct Leads.

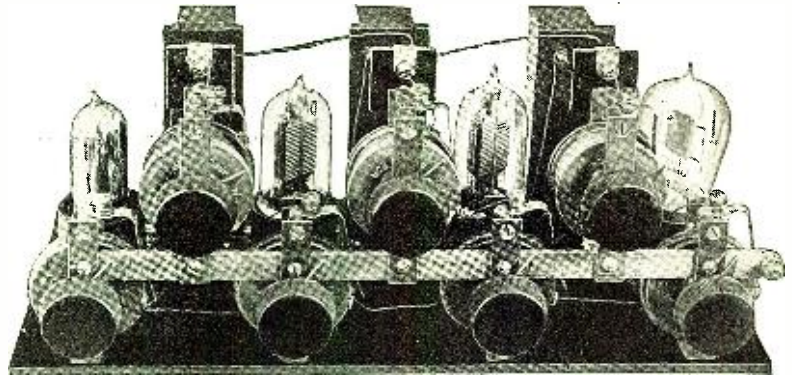

where every screwed or clamped connection is eliminated or bridged by solder skillfully applied.

In the diagram, Fig. 3, the solid lines show the set as above described, while the dotted lines show the externally connected apparatus. At the left is the loop 4' square of eight turns spirally wound $\frac{1}{4}''$ apart and shunted by an 11-plate vernier condenser. At the right are connected the 88-volt "B" battery (four banks of miniature storage

Stabilizer potentiometer, P1, controls the grid voltage of the first two tubes, while P2 acts likewise for the third tube. Potentiometer, P3, affords fine adjustment of the plate voltage of the detector tube.

Several different kinds of tubes were tried in the set which is now being used with UV-201A throughout with good results. Quite a few new stunts are at once discovered by one starting to work with radio frequency. Sometimes a difficult station is unexpectedly separated from a strong station and tuned in by slightly changing the filament heat of one of the tubes.

The grounding of the filament side of the loop in some cases increases the signal strength. Sometimes in tuning sharply for maximum resonance the signal will "kill" and silence ensue. Instead of picking up again by rotating condenser or potentiometer, reception is instantly restored by momentarily touching with the finger the grid terminal from the loop.

Certainly a rare treat awaits the enthusiast willing to expend the necessary time and care in assembling three stages of radio frequency. Fortunately, in the present case, reception was obtained as soon as the "A" battery switch was first closed and a few turns of the knobs made, so no time was needed in eliminating "bugs." It only, therefore, remained to become accustomed to the proper manipulation of the set to know how best to pick up desired stations.

Under summer conditions, reception at White Plains, N. Y., from Western points such as Davenport (WOC) and Chicago (WDAP, WJAZ, KYW), is so loud with a head set as to be uncomfortable and with Magnavox connected could be heard throughout the room. The near and semi-near stations could be developed too loud for the head set, and when placed on the Magnavox were heard through the house, the length of three rooms away. These re-

(Continued on page 807)

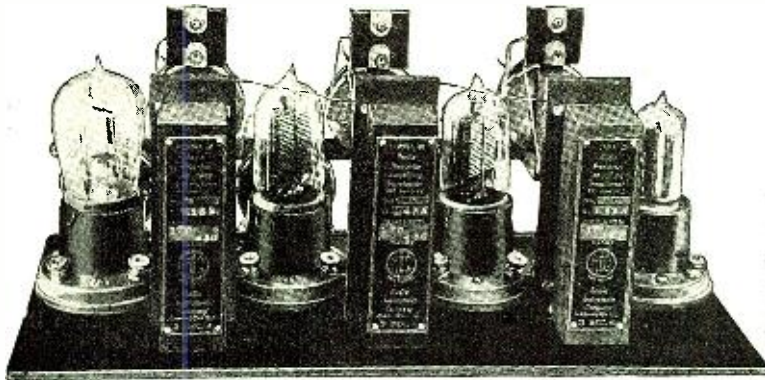

A Rear View of the Same Set Showing the Arrangement of the Radio Frequency Transformers and Tubes.

the four sockets and three Radio Instrument DX-1 radio frequency transformers were mounted. This whole system, as shown in Fig. 1 and Fig. 2, was perfectly rigid and could be lifted and carried by any knob of any of the rheostats or potentiometers.

While this method of assembly was devised for temporary work it has been found so satisfactory from mechanical and operative standpoints that the outfit will be retained as one of the writer's permanent sets. It is very simple to supply a bakelite front with seven holes to pass the seven knob shafts.

It may be of rather revolutionary interest to know that the connections in this set are all made without solder and are made better than the connections in many former sets which were supposed to be elaborately soldered. The writer does not see the virtue of carefully soldering a lug to the end of a wire and then clamping the lug under the head of the binding post of a rheostat, socket, transformer or other instrument.

In the case of the set illustrated, each wire, No. 16 B&S gauge round copper, was cut to the proper length and a small circular loop formed on each end. This loop, then laid on an anvil, was flattened with a hammer, and became a lug continuous with the wire itself, without solder. This is really a safer method for the novice or experimenter than the risk of having soldering flux about a set, although it is not offered the real amateur as equivalent to a sure enough soldered circuit throughout

cells), the six-volt "A" battery and the phones.

The heavy band at the bottom of the diagram indicates the bus-bar carrying the rheostats and potentiometers and thus eliminating seven connections, which would ordinarily be required, to these instruments. The unused terminals on the potentiometers are utilized to support the Micadon "postage stamp" condensers to by-pass radio frequency around the slight inductance of the potentiometer winding.

On the plate terminal screw of the detector tube socket the frame of a phone jack is bolted and the bridging condenser of the same type above mentioned is sprung on to the jack springs.

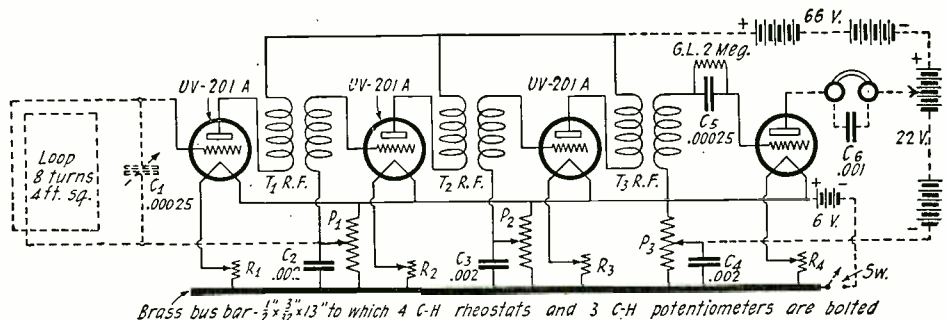

The Circuit Diagram of the Receiver Described in This Article. This Consists of Three Stages of Radio Frequency Amplification and a Detector. Perfect Control of the Amplifiers is Accomplished by the Use of Three Potentiometers.

A Regenerative Loop Receiver

By EDWIN K. BORCHARD, A. M. A. S. C. E.

A SINGLE CONTROL, SINGLE TUBE, SELF-CONTAINED LOOP RECEIVER SUITABLE FOR LOCAL RECEPTION, WITH POSSIBILITIES FOR DX WORK

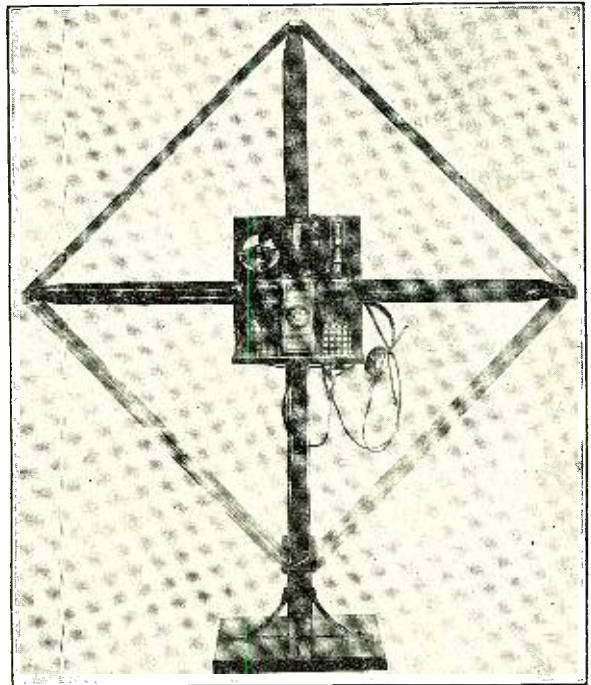
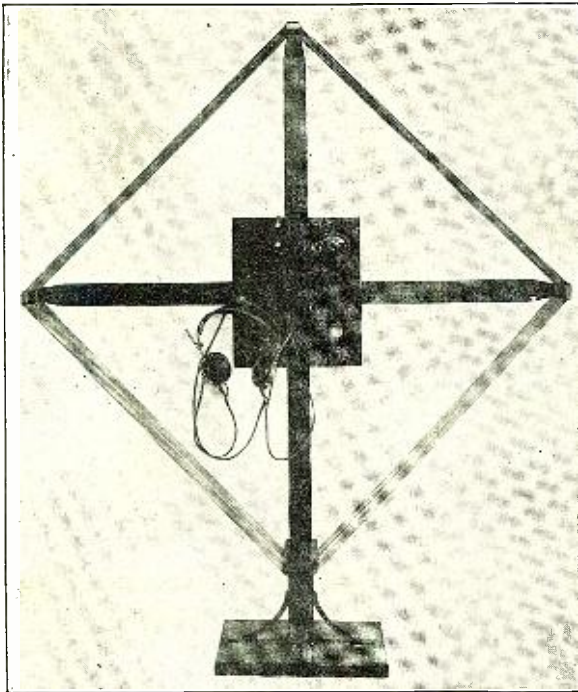

The Front and Rear Views of the Regenerative Loop Receiver. All of the Apparatus Including the Batteries is Mounted on a Panel and Base in the Center of the Loop Aerial Frame.

THIS loop was developed in a search for a simple hook-up for local reception only. The circuit involves no new principles. Its chief advantage is for local reception in the near vicinity of several broadcasting stations where separation is difficult when using an outside aerial.

When employing the regulation loop with the ordinary regenerative receiving set, consisting of variocoupler, condensers and perhaps variometers, the set itself adds a considerable amount of resistance to the circuit. This extra resistance can be eliminated by making the loop self-contained and by having the inductively coupled plate circuit regenerative within the loop itself. The loop shown has 30" sides and is 50" high over all. It is wound with 10 turns of silk-covered stranded wire. The wires are spaced 1/2" apart. The base is 10" square, on the bottom of which are fastened four of the nickel-plated domes used on furniture, to enable the loop to be easily turned.

Fig. 1 shows the front of the loop. All tuning is done by means of the single condenser-dial, the only other control being that of the rheostat. Since the condenser constitutes the entire tuning element, the dial may be graduated directly in wave-lengths or kilocycles. When the ordinary variable condenser with semi-circular plates is employed, the dial must be specially graduated in wave-lengths. This can be done by pasting over it a disk of paper and then calibrating this by the various stations; or, as was done by the writer, calibrating with the Bureau of Standards' standard wave-length signals.

A vernier condenser is absolutely necessary for tuning, in fact, when using a 24-plate condenser with a single-plate vernier, it was found an advantage to lower the capacity of the vernier by cutting off a portion of the movable plate, thus making possible sharper tuning.

With the loop shown, regeneration is accomplished by a single turn in the plate-to-filament circuit with eight turns in the loop proper. With a 22 1/2-volt "B" battery this single turn will feed back sufficiently by induction on to the grid-to-filament circuit to place the tube in an oscillating state.

DX RECEPTION ALSO POSSIBLE

While the loop was designed primarily for strictly local reception, and brings in local stations within a radius of 25 miles with ample strength for ear-phone reception, the DX results with a single tube are quite surprising. Except under very favorable conditions, it is necessary to have the tube oscillating before DX results can be obtained. This is not objectionable to other broadcast listeners because a loop has very weak f-radiation, unlike the regenerative set using an outside aerial.

With the tube just over the oscillating point, the distant stations are searched for by the usual method of the heterodyning whistle. The signals are then, usually quite weak and are somewhat cut up, but quite distinguishable after careful tuning with the condenser vernier and the rheostat which should preferably be vernier adjusting. With a larger loop having a side 48" long (otherwise exactly the same as the one illustrated) and located near New York City, distant points such as Davenport, Iowa, Chicago, Atlanta and Pittsburgh are picked up under favorable conditions. Nearer points such as Philadelphia, Schenectady and Springfield,

Mass., can be picked up evening after evening, even in the summer months. Occasionally these nearer stations can be picked up without oscillation by extremely careful tuning. *It must be borne in mind that no claims are made for distant reception and the picking up of such stations should be regarded more as a curiosity than anything else, since the signals are not sufficiently strong or satisfactory to listen to for any length of time.* Static trouble is much less perceptible than with an outside aerial.

CONTROL OF REGENERATION

From the circuit-diagram, it will be noted that the 8th, 9th and 10th turns are provided with binding posts so that the plate-to-filament circuit can be connected to include either two turns, one turn or no turns of the loop. By connecting the lead from the minus terminal of the "B" battery to the 8th turn, the circuit is non-regenerative; when connected to the 9th turn it is ready for use under average conditions; and when connected to the 10th turn it gives maximum regeneration or oscillation. The 10th turn is used only when the batteries are somewhat weakened and do not give oscillation on the 9th turn. (Continued on page 736)

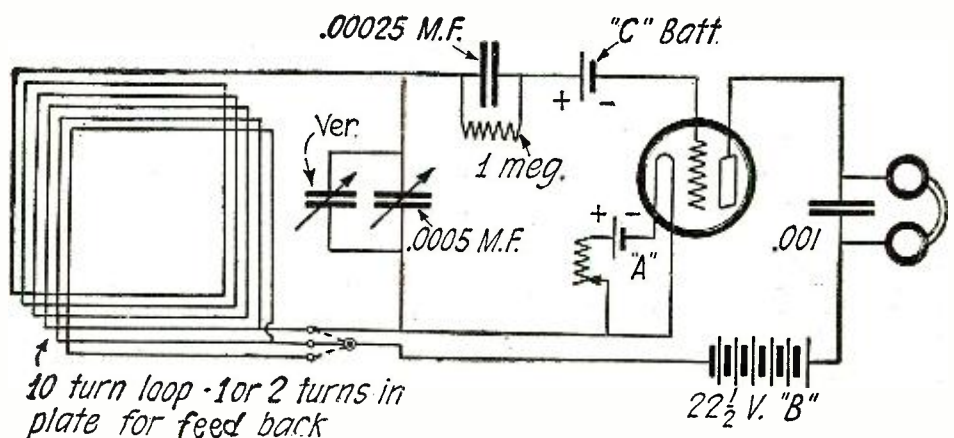

Circuit Diagram of the Regenerative Loop Receiver. A Portion of the Loop Acts as a Tickler Coil. All Tuning is Done With the Variable Condenser.

Notes on the Autoplex Circuit

By M. L. MUHLEMAN, A.M.I.R.E.

FURTHER information has been called for on the operating characteristics, working distance and detailed design data of the Autoplex receiver. In order to cover these subjects it is best to take into consideration a portion of the results accrued from past experiments.

First of all it is to be understood that the Autoplex receiver is but a modified form of super-regenerative circuit. To be specific it is a common form of one tube super, minus

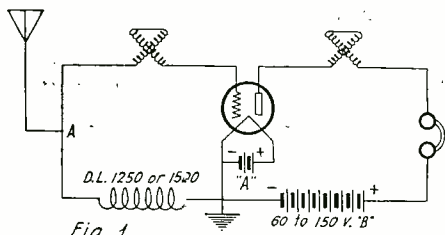

Fig. 1
The Circuit Diagram of the Autoplex Receiver. It Employs Two Variometers and a Large Honeycomb Coil.

one of the large oscillating coils and all lumped capacity (except that existing between the elements of the vacuum tube and the capacity of the aerial and the set to earth). Its satisfactory operation is based on simplicity above all and secondarily on the electrical efficiency of the apparatus employed.

ADVANTAGES OF PARTS USED

While speaking of its simplicity, it is well to mention the primary reasons for using the various parts it is composed of. A vacuum tube having large elements and consequently an increased internal capacity is most favorable since considerable regeneration (reaction) is desired. The tickler feed-back system of regeneration being rather critical when utilized in a super-regenerative circuit, was discarded in favor of the tuned plate method with which the control is less complicated and better advantage taken of the inherent capacity of the vacuum tube. Furthermore, by the use of two variometers, one in the grid circuit and one in the plate circuit, impedance of both grid and plate circuits can be easily and most effectively adjusted to the same value or values most suited to the L.C. characteristics of the large coil.

There are a number of ways of producing low frequency oscillations in a regenerative receiver to bring about the super effect. Among these are the tube blocking system which introduces large capacity in the circuit and double regeneration which is quite difficult to control. The method of using large inductances, the L.C. of which corresponds to a suitable low frequency, is by far the best, since they will oscillate when placed in an oscillating circuit which excites them.

Referring to Fig. 1, let us consider the oscillating circuit. Radio or audio frequency currents traversing this circuit are not impeded to any great extent, since the self capacity of both the phones and the oscillating coils are sufficient to pass both the radio and audio frequency oscillations, the latter of which have considerable amplitude. The by-pass capacities are therefore not necessary; the use of them in fact, considerably broadens the circuit characteristics. It will be noted that the collective agency (aerial or ground) is connected between the large coil and the grid variometer; this is quite important. The capacity existing between

the aerial and the ground should not be introduced across the variometer. Both grid and plate variometers should be free from capacity and the self capacity of both should be low.

COLLECTIVE AGENCY

As mentioned in the previous article, most any type of collective agency can be used. One thing of importance is that better results will be had by using a good ground connection to point "A" than if the ground is left at point "B" and a make-shift aerial connected to "A." In all cases connect the best collective agency to the top (A) binding post.

TUBES USED

Practically every type of vacuum tube has been tried in this circuit and all have worked. The small capacity tubes, of course, do not deliver as much volume and where possible a large capacity tube such as the UV201-A, C301-A, VT-2, 216-A or UV202 should be used. The smaller tubes require less "B" voltage; about 45 being correct. For the larger tubes, 60 to 150 volts are advised. A filament rheostat is not necessary since the filament adjustment is not critical, however, when using tubes that require large filament current, it may be well to use a rheostat in order to conserve the storage battery.

OPERATION

The operation characteristics of the Autoplex circuit are similar to those of a super-regenerative circuit. The correct functioning of the receiver is denoted by the presence of a very high pitched whistle in the phones or loud speaker. If a small oscillating inductance is employed (this applies to short wave reception only), so that the variation frequency is super-audible, it is possible to determine if the super-action is being obtained by the manifestation of a comparatively loud rushing noise when resonance or balance points are reached. This noise is

even more noticeable when an audible variation frequency is employed. In tuning, it is best practice to vary both variometers simultaneously and for every movement of one, follow up with the other until the rushing noise, mentioned before, is heard. Thus one can run from zero to 180°, keeping at balanced points throughout the scale readings. This should always be followed for it is at resonance points that the stations are picked up. If the grid and plate circuits are un-

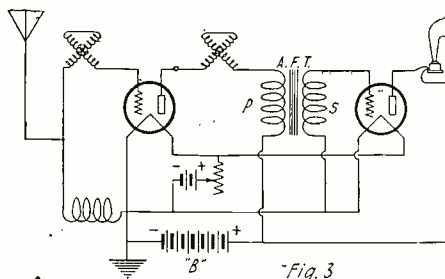

Fig. 3
The Addition of One Stage of Audio Frequency Amplification to the Autoplex Circuit Will Produce Great Volume of Signals.

balanced, there is small possibility of picking up signals. This is particularly true of the plate variometer adjustment. The scale readings on both variometers will in the usual case be practically the same at the resonance points.

It has been noticed in numerous instances that transmitting stations at considerable distances have been received as well and sometimes better than local stations. Also, when employing inefficient collective agencies, the volume and quality of nearby signals are considerably improved. This peculiar performance might be attributed to shock excitation which would tend to destroy the sensitive characteristics of the vacuum tube brought into play by the use of the super effect. On top of this, Mr. H. Andrews, in his article entitled "Some Laboratory Experiments with the Armstrong Circuit (The Wireless World and Radio Review, September 12, 1923), discloses some very valuable information on this point. By actual experiments, he has proven that the amplification factor of a super-regenerative circuit increases as the signal strength decreases, and decreases considerably as the signal strength increases. The curve shown in Fig. 2 illustrates the results of his experiments and was obtained by the use of a circuit driver as a transmitter. In order to get the high points of the curve, it was necessary to enclose the circuit driver in a zinc casing and place it some distance away from the super-regenerative receiver.

These facts are both interesting and distracting. They cast considerable light on the sensitiveness of the super-circuit, but demand some suitable means by which incoming signal frequencies can be regulated as to amplitude.

It is well known that in both crystal and vacuum tube the greatest current changes take place at rather critical potential points. A high potential will shift the points of the grid curve of the vacuum tube to such an extent as to make the plate current changes small. This action can be off-set to an extent by proper grid bias, however, in a super-regenerative circuit, the grid bias is not constant at all adjustments, due principally to the effects of the amplitude of the variation frequency. As pointed out by Mr. Andrews,

(Continued on page 818)

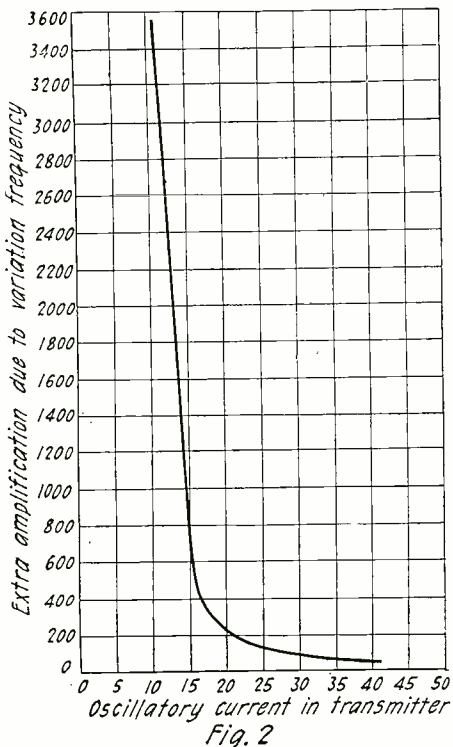

Fig. 2
A Curve Illustrating the Increase of Signal Strength in a Super-Regenerative Circuit with a Corresponding Decrease in the Transmitter Current.

Observations at the Receiving End of the Radiophone

By W. A. KNIGHT, M. E.

FOR the purpose of making observations on radiophone reception from different stations and securing records that could be analyzed at pleasure, a mechanism was constructed by which audibility diagrams could be obtained. It was thought, too, that such records might throw some light on the problem of fades and variability of speech.

The device is shown diagrammatically in Fig. 1. It is a very simple affair, consisting

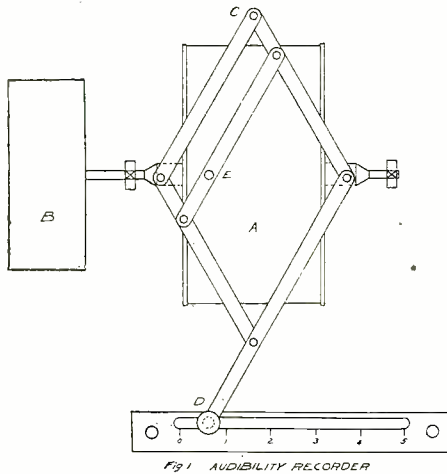

Line Drawing of the Audibility Recorder Used by Mr. Knight. This is Quite a Novel Arrangement.

of a drum, A, driven by a clock, B. Over the drum there is a parallel motion, one end of which is pivoted at C. The other end, D, engages a slot in a graduated plate. The slot in this plate is parallel to the axis of the drum. The parallel motion carries an inker over the center of the drum at E. The drum is 18" in circumference and geared to make one revolution per hour. On the diagram then, 3/10" equals one minute. In operation, the drum is rotated by the clock, the operator moves the free end of the parallel motion back and forth in the slot, varying its position in accordance with his judgment of the loudness or weakness of the incoming signals.

It must be admitted that there is a large personal factor in this method of recording radiophone reception. However, an automatic sound recording device would not do (unless signals were of uniform strength), because the object is not to record variations in the magnitude of the sound that comes in, but to follow variations in the reception as a whole. The most satisfactory observations were made when market reports, news items and short addresses were being sent out. Any variation in speech could be followed with a measurable degree of accuracy. Dance music was fairly easy to follow. Orchestral music and vocal solos were more uncertain, as it was difficult at times to judge whether a change in loudness was due to transmission or to a movement in the selection being rendered. The most difficult to follow was church music and symphony orchestras, but these were avoided as much as possible. When, as is generally the case, a mixed program was being sent out, the announcer's voice served as a check. In this way and by

paying close attention to details, it is thought the results could be made fairly reliable. The most difficult situation to handle was when the speech varied from one extreme to another with great rapidity, frequently changing in the middle of a sentence or even a single word. It was impossible to follow this kind of variation in any but a general way. Normal, clear speech was taken as the standard. Fig. 2 shows a typical diagram. This was taken from WWJ, Detroit News, between the hours of 6:00 and 7:00 p. m., February 8. It will serve to illustrate the record of a mixed program.

APPARATUS USED

All observations were made with a Westinghouse Aeriola Senior receiving set, using a WD-11 detector tube. No amplification of any kind was used. At the suggestion of Mr. Perry Okey, of this city, one change was made in this set. The connection of grid condenser was changed to go directly to the ground instead of first passing through the "A" battery. Otherwise the set was just as purchased. The antenna is of No. 14 stranded wire, 100' long, and runs due north and south at an average elevation of 25' above ground. The outer end is provided with a rope and pulley and is weighted to maintain constant tension. The lead-in is made as direct as possible and is of No. 14 rubber-covered wire. The tube filament is supplied with current from one cell of a storage battery, as it was thought that this would give more uniform results than the usual dry cell. However, the filament was not run above a low to fair red heat. The tube, originally purchased with the set, is still in use and is giving satisfaction.

Observations were begun February 2, 1923. It was the idea to take two east and west stations and two north and south. For various reasons this plan had to be modified.

distance to Fort-Worth is about 960 miles.

COMPARATIVE RESULTS OBTAINED FROM SEVEN STATIONS

Ten diagrams have been taken from each of the seven stations. Of the ten from WLW; Cincinnati, five were taken at 10:00 a. m. and five at 10:00 p. m. Two representative diagrams from this station are shown in Fig. 3. It is to be observed that the day transmission is very smooth and normal most of the time, while that at night is very variable. Also contrary to usual results, the daytime transmission is much better than that at night. The average audibility of the seven stations is shown in Table I. WOC, Davenport, Iowa, has the highest average, while WDAJ, College Park, Ga., the lowest. Considering the distance which is over twice that of its nearest competitor, WBAP, Fort Worth, Texas, does remarkably well. On the basis of distance, KDKA is weak. This is due to the extreme variability of KDKA. A report direct from the Department of Commerce, Washington, D. C., under date of February 8, gives 500 watts as the output of each of these stations, with the exception of KDKA, which is given as 1,000 watts. If we leave this latter station out and take the other six, an average of 59 per cent normal, clear speech is obtained for 500-watt stations at an average of 430 miles. Typical diagrams are shown in Fig. 4.

Of more than 70 diagrams taken, only four show continuous normal speech of over 25 minutes. The record is held by WWJ, which on March 21 held continuously for 51 minutes. The second best record is also held by WWJ. This was for 33 minutes on March 20. WBAP takes third and fourth positions, with 28 minutes on March 23 and 26 minutes February 21. The following gives the best continuous normal speech from the other stations: KDKA, 15 minutes February 20; WOC, 19 minutes, February 18; WSB, 21

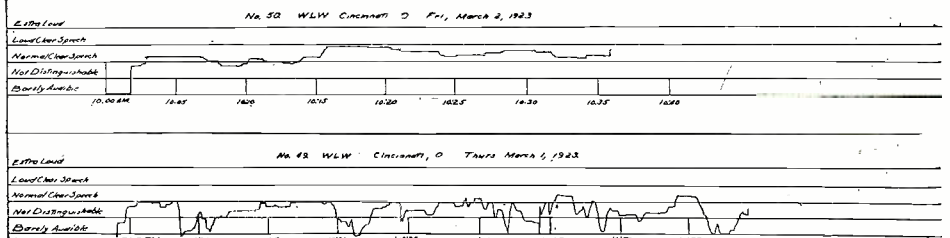

Fig. 3 Audibility Records Taken of Station WLW. Note the Abrupt Changes at Different Time Periods.

Detroit lies due north of Columbus at a distance of 180 miles, while Atlanta, Georgia, distant 450 miles, is nearest south, lying about 10 degrees to the west of south. Hence, these two were selected for the north and south stations. Also since there were three stations operating at Atlanta, the way was open to make comparisons between them and see if fade-out was common to all. Kansas City lies nearest to west, but its schedule did not lend itself so readily to observations, hence WOC, Davenport, Iowa, was chosen for the western station. KDKA East Pittsburgh, was selected for the eastern station. WLW, Cincinnati, and WBAP, Fort Worth, Texas, were added to the list because they lie in practically the same straight line, Cincinnati at a distance of 100 miles, while the

minutes, March 2; WLW (night transmission), 17 minutes, March 6; WDAJ, 13 minutes, February 14. It is not meant that fade-outs were complete, but speech weakened and in many cases the fade-out was complete. It should be remembered that the figures are for the best performance of each of the stations. For instance, the average longest period of normal speech from the ten diagrams taken for KDKA is about 6 1/2 minutes. If we take account of all the fade-outs from that station, there is less than a three-minute interval between them. This, of course, is for the locality of Columbus, Ohio. No doubt reception may be, and undoubtedly is, better at some other places. It will be seen from this how unsatisfactory average radiophone service is.

EFFECT OF CODE SIGNALS ON SPEECH WAVES

Sections of speech are cut out by code. Weakening, wavering and other effects are due to the same cause. Just which form interference takes depends on the angle the code makes with the line transmission. The writer's location happens to be within a third to half a mile of three high-powered amateur

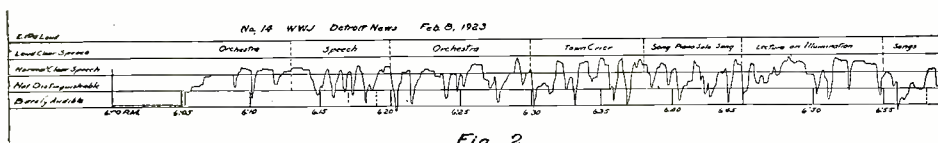

Fig. 2 Those Taken of WWJ Had Pronounced Changes in Audibility.

code sending stations. These cause great annoyance at times, but, on the other hand, have afforded an excellent opportunity for a study of the effect of such code on incoming signals. When reception is from the south and a southeast code station opens up, the effect is to sharply cut out sections of speech. In this case the code crosses the line of transmission at approximately a right angle. If signals are coming in strongly, the effect is not so pronounced, but there is more or less blotchiness. From the southwest, signals are interrupted, but not with the same degree of sharpness. From Davenport, Iowa, the effect is found to be a weakening and wavering of the speech. In this case the incoming signals are met head-on. From Detroit the effect is the same, but of lesser degree. For some reason this station seems to be the least affected of any received here. From the east the effects are about the same as from the south.

This chopped out effect has been noted on signals from distant stations when there was no evidence of code whatever at the receiver. It is difficult to see, however, how sections of speech once cut out on passing a given point can ever get back in again. Hence, the inference that when that kind of reception is observed there is a code sending station somewhere on, or near, a direct line between the sending and receiving stations.

Station WEAO of the Ohio State University lies directly south of the observer's location at a distance of only three blocks. It frequently happened that this station opened up while observation was being made on a distant station. On one occasion, while holding WWJ, his speech was cut off so suddenly that a note was about to be entered that WWJ had blown up a tube when the shrill whistle of WEAO revealed the real cause. On this occasion there was no mewing or other disturbance at the receiver to indicate the cutting in of another station.

Since Detroit is stopped absolutely at this point, it must be evident that reception at points beyond this but in line with WEAO and Detroit would be affected by the projection of WEAO's agitation into the wave-carrying medium.

There would be a sort of a wave or shadow cast by WEAO and every receiver within that shadow would be affected. The shadow would not be sharply defined as from a source of light, but the sharpness of the shadow cast by light is due to the shortness of wave-length and not to any characteristic of the transmitting medium. Electro-magnetic waves, being very much longer, tend to close in around an obstacle so that, as the distance from the disturbing element increases, the effect grows less. Also since transmission waves are constantly deflected downward there would be a point at and beyond which a receiver would pick up waves practically free from distortion. The area affected would probably take the form of an ellipse with WEAO as one of the foci.

WWJ broadcasts on approximately 400 meters. WEAO on 360. An observer within the shadow area tuned to Detroit would get none of WEAO's signals, but would get more or less distortion, a weakening and wavering of speech, and other effects so commonly noted. There would be no indication to such an observer that interference came from a 360-meter station. No amount of tuning or adjustment would eliminate such interference, because the distortion is in the waves when they reach the receiver. This might be called indirect interference, since it would manifest itself as an effect rather than

as a cause. Conversely, that within the range of audibility or that which can be identified as a cause may be termed direct interference.

EFFECT OF NEARBY STRUCTURES ON WAVES

In this locality KDKA is an extremely variable station. It suffers at times from direct interferences from Cleveland, Cincinnati and other points, but it will flare up, wobble, go through all kinds of contortions, die out, and then repeat the performance all over again when there is not the least evidence of another station working within 15 meters of it. To reach this point the radia-

the relief expected. That it will do some good goes without question. It will do away, very largely, with direct interference, but this will not clear the air and remove the handicap under which broadcasting stations are laboring. There is a general tendency to throw greater power and more of it into the ether. Smooth transmission cannot logically be expected under such circumstances.

INDIRECT INTERFERENCE MAIN DIFFICULTY

It is believed that indirect interference is largely responsible for fades and that it acts in two ways—first, by agitation of the wave-

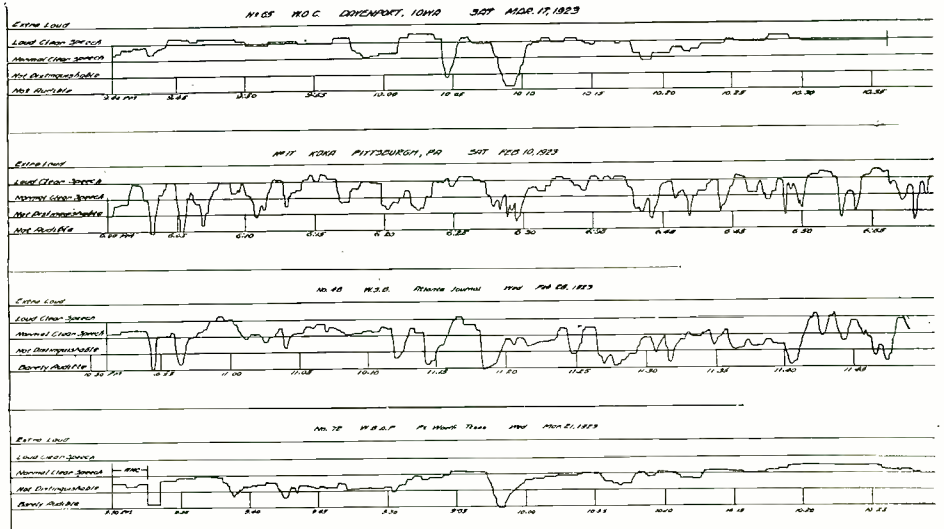

Fig. 4 An Assortment of Records Taken of Middle West Stations. The Lowest, a Distant Southern Station, is by Far the Most Satisfactory.

tion from that station must pass over the city of Pittsburgh and the chances are that it is all shot to pieces before ever getting a running start in this direction.

All observations tend toward the conviction that there is a very close analogy between sending out sound signals in the air and radio signals in the ether. Stations that are favorably situated with reference to sending out their radiation are the ones that give the best service. It is very probable that this is the reason Fort Worth, lying in the same straight line with Cincinnati and at ten times the distance, is received here with about twice the average audibility of the latter station. The radiation from Fort Worth can get into the upper reaches of the atmosphere and be received here on a downward slant, passing over the agitation that affects Cincinnati. Yet Fort Worth suffers considerably from direct interference. Hardly a night passed, while observing on WBAP, without more or less of this.

WLW, Cincinnati, is subject to both direct and indirect interference, the radiation received here never rising high enough to escape the low-lying agitation in the ether caused by the other stations, code senders, faulty electrical machinery, transmission lines, traction lines, and so on. This is directly contrary to the generally accepted belief that interference results only from stations on or near the same wave-length and that the remedy is to separate them. The prediction is here ventured that increasing the wave band of broadcasting stations to from 225 to 545 meters is not going to afford

carrying medium, and, second, by its ionizing effect on the atmosphere. Observations while local stations were in operation show that there can be effects anywhere from very slight interference to complete extinction of incoming signals. There is no reasonable doubt but that such effects are carried beyond this point.

The diagrams from Fort Worth show more fades and less normal speech from 9:35 to 10:00 than from 10:00 to 10:25. On the other hand, from WSB, Atlanta, the reverse is the case. Thus transmission from Fort Worth grows better, with fewer fades as the night wears on, while from Atlanta transmission weakens and fades increase. The inference is that other operating stations or industrial causes are responsible.

On the night of April 20, KDKA and WCAE of Pittsburgh were operating at the same time. When WCAE had almost faded out, a quick switch was made to KDKA, which came in clearly and strongly at the time. The switch from one to the other was repeated 23 times and on six occasions one station was very weak while the other was strong. This shows that there can be strong transmission and fades between two points at the same time.

The conclusions drawn from the observations are:

- (1) That serious interference can and does result from stations operating on widely different wave-lengths.
- (2) That this interference and other industrial causes, including heat from furnaces, are in a large measure responsible for fades, strained and variable transmission.
- (3) That such causes act in two ways: (a) By agitation of the wave-carrying medium. (b) By ionization of the surrounding atmosphere.
- (4) Those stations most favorably situated with reference to getting their radiation away with proper location, construction and height of antenna, are the ones that render the best service.

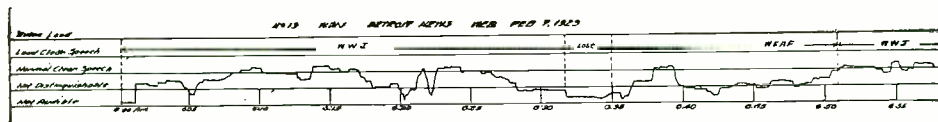

Fig. 5 Another Very Interesting Curve Representing the Audibility of WWJ and WEAO at Different Intervals.

Crystal Detectors and Their Possibilities as Amplifiers and Oscillators

By JOHN W. MILLION, Jr.

CRYSTAL detectors, while very commonly used, are not well understood by the average user. Very few articles have dealt with the general characteristics of crystal rectifiers. In fact, the actual explanation is unknown although several theories have been advanced, a few of which will be explained later.

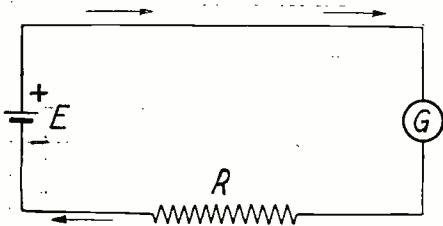
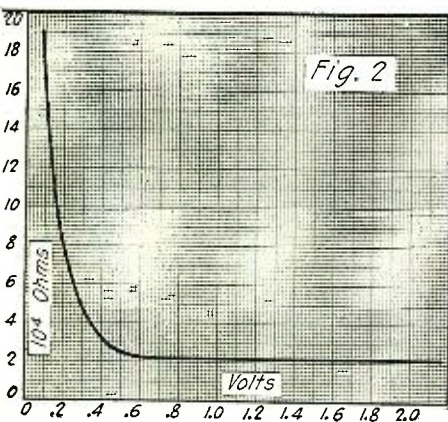

Fig. 1

A Circuit Containing a Source of Current and a Resistance.

The statement that a crystal exhibits unilateral conductivity is commonly made the basis for explaining the action of a crystal detector in a receiving circuit. By unilateral conductivity is meant the fact that the crystal will, for a given voltage, allow more current to flow in one direction than in the other. To fully understand the application of this, an understanding of Ohm's Law is essential. Consider the circuit in Fig. 1.

The current I , in amperes, flowing through the circuit is equal to the electromotive force E , expressed in volts, divided by the resistance R , in ohms. In mathematical symbols $I = E/R$, this being independent of the direction of the current. It is evident then that crystals do not obey Ohm's Law. Applying this to our crystal circuit it is evident that a change occurs in the crystal and that it is the resistance of the crystal that changes. That is, the resistance of a crystal is greater to a flow of current in one direction than in the other. However, unilateral conductivity is not a complete explanation of the properties of a crystal, as may be seen from the fact that the resistance of a crystal changes, not only with the direction of the applied voltage, but also is decidedly changed by an increase in the applied voltage in the same direction. It is to be remembered that the resistances of most substances is for all practical purposes a constant. The variation with applied voltage in the same direction gives rise to the use of a local battery for detection.



The Resistance of a Crystal Automatically Decreases as the Voltage Applied to it is Increased Until a Certain Point is Reached. Thereafter There is No Appreciable Variation.

To determine the properties of a detector apparatus is set up as in Fig. 3.

A voltage, as indicated by the voltmeter V , applied to the circuit is varied from 0 to 1.0 volt by moving the slider on the potentiometer P and the deflection of the galvanometer G recorded for each setting of V . The readings should be taken every .05 of a volt. The direction of the applied voltage is reversed by the switch S and the process repeated. This gives the variation of the current with the applied voltage in both directions. For quantitative work the deflection of the galvanometer must be reduced to microamperes. The phones are placed in the circuit, as they of necessity are always present in the receiving circuit. The detector D must be adjusted to a sensitive spot before taking readings and should be tested afterwards to be sure that during the observations it was not jarred out of adjustment. Plotting the voltage applied against the current, or deflection of G , a curve similar to Fig. 4, will be obtained.

Fig. 4 was obtained using a galena detector. It is readily seen that a voltage of .1 applied in the positive direction produces a

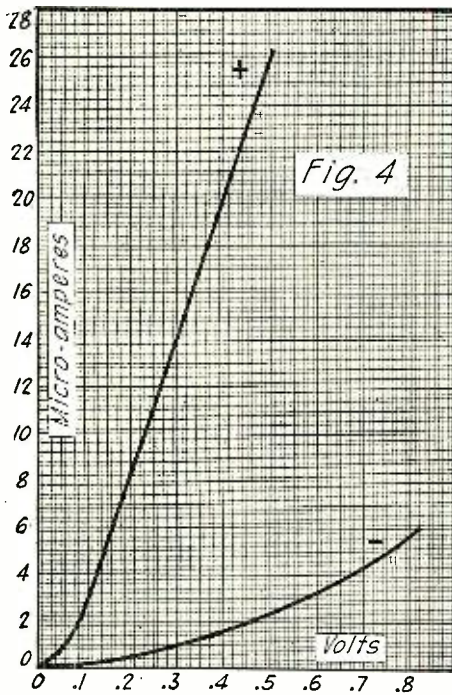

Characteristic Curve of a Rectifying Crystal When Numerous Voltages Are Applied.

current of 2.7 microamperes and that the same voltage applied in the opposite direction produces a negative current of .3 microamperes. One-half the difference, or one-half the algebraic sum of the two, will be approximately the value of the direct current resulting from the application of an alternating voltage of .1 volt to the circuit, or 1.2 microamperes. This curve shows most efficient rectification (largest D.C. current for given A.C. voltage) without a local battery. Fig. 5, however, is the curve of a crystal giving maximum rectification with a local battery of about .25 volts.

In this case the calculation is the same for zero volts local battery and gives a rectified current of .02 microamperes. With a local battery the process of calculation is decidedly changed. If its value is .25 volts with an A.C. voltage of .1 volt applied, we have first an applied voltage of .35 positive and the .15 positive. In this case one half

the difference between the increase and the decrease due to the A.C. voltage is the rectified current. That is .35 volts...9.3 milliamperes; local battery .25 volts cont. D.C., 4.2 milliamperes, .15 volts cont. D.C., 1.5; 5.1 inc. diff. 2.4 rectified current; 2.7 dec. 1.2. The dotted lines show the change in the rectified current as the voltage of the local battery is increased and the maximum is clearly indicated. It is to be remembered that no two sensitive spots give exactly similar curves and some spots on silicon are just about as sensitive without a local battery as with one. These curves cover the simple cases and are usually sufficient.

A few other curves are very interesting and in some cases rather important in differentiating between crystals, especially, when the detector is used on loud signals as, from very close stations, or when using several steps of radio frequency tube amplification. This is shown in Fig. 6 and Fig. 7. Fig. 6 is the voltage current characteristic for galena (-C), silicon and carborundum (-B), and a theoretical curve (-A). The curve marked plus is taken as the positive curve for all four crystals. Fig. 7 is a calculated curve showing the rectified current for increasing A.C. voltages for the three types. It will be noted that for galena the rectified current increases without limit, while for silicon and carborundum it rises to a maximum value, and, for the theoretical curve, it actually decreases with an increase in the applied A.C. voltage above .5 volt. With the great amplification possible at radio frequency, such a voltage may be reached and at half that value the rectified current is less than for galena. Thus, for loud signals the greatest efficiency may be obtained with galena or iron pyrites which have moderately flat negative current curves. Of the two pyrites is to be preferred because of its greater stability and the fact that it is not as readily burnt as galena. Many will remember the Crystaloi detector of earlier days that had to be shorted out while transmitting, or in a little while the galena was burnt up.

As yet the author has found no crystal that corresponds to the theoretical curve. Many minerals, however, show a similar effect to that shown by silicon and carborundum of a limiting value for the rectified current. In some cases the curve (-B) is not exactly parallel to the plus curve and in that case the current continues to increase but very slowly, hence the familiar statement that the smaller the current the more efficient the rectification.

Let us now consider the natural circuit for amplification using crystals. The fact that the crystal has a straight portion of the curve and is similar to the familiar tube curves leads one to believe that the crystal would amplify if a battery were used to bring the straight portion of the curve into use. Fig. 8 shows this circuit for use at

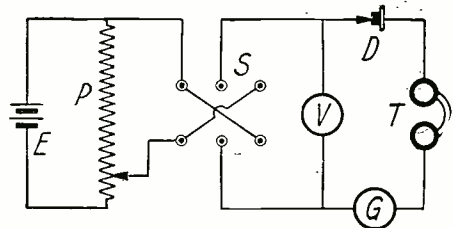
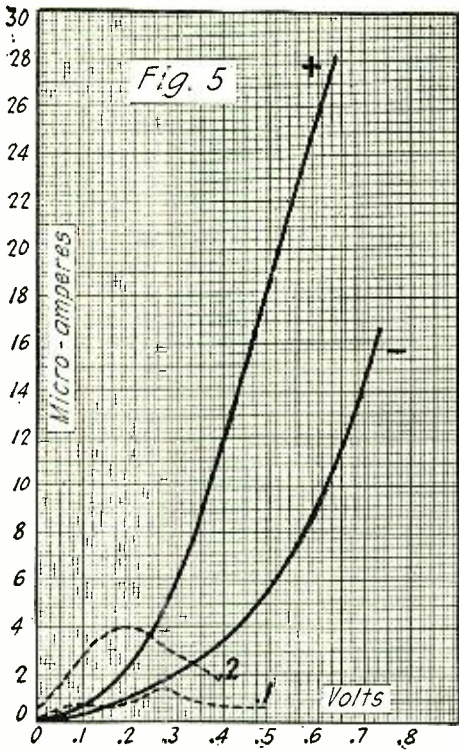

Fig. 3

Apparatus and Circuit Employed in Determining the Properties of Rectifying Crystals.



In This Particular Case, as Shown by the Curve, Maximum Rectification is Obtained with a Local Voltage of .25.

radio frequency. A 1.5-volt dry cell is used to insure operation on the straight portion of the curve. Hooking up this arrangement, the author found a decided increase in signal strength. This, however, COULD NOT be amplification due to the crystal. The explanation involves Ohm's law and the resistance of the crystal as shown in Fig. 1 and Fig. 2 respectively.

From Fig. 2 it will be seen that the resistance of the crystal becomes constant. In other words the resistance is the same for an applied voltage of 1.0, 1.5, and 2.0. Therefore, if a 1.5-volt battery is used and an A.C. voltage of .5 is applied, the resistance of the crystal does not change in any way. If this is true, the crystal may be replaced by any other resistance of the same value without affecting the signals. This is shown to be the case by shorting the crystal with a switch. That is, the straight portion of a crystal curve merely indicates that the resistance has become constant. The effect is explained by link coupling and is a phenomenon of coupled circuits. Another important fact is that the local battery in crystal work is similar to the "C" battery in tube work and not the "B" battery.

The tube being our best oscillator and only regenerator or radio frequency amplifier in use, it is natural to attempt to conform the crystal to the essential characteristics of the tube, the change in resistance with applied voltage which crystals possess. The requirement then is an arrangement of crystals employing two cir-

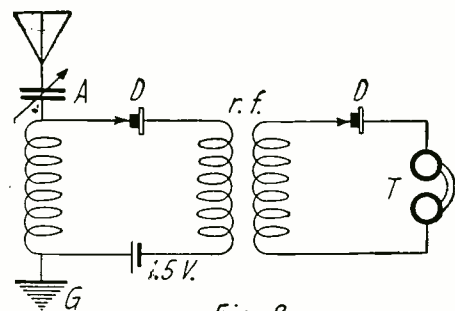

A Theoretical Circuit Tried in an Attempt to Obtain Amplification with Crystals.

uits so that the received energy applied to one circuit will control local energy in the other circuit and of course in order to be of use, the local energy released must be greater than the received energy. With two such circuits, the second may be coupled to the first and regeneration results. For oscillations, the current upon regeneration must rise to a maximum and then fall to a minimum and these fluctuations about a mean value must be symmetrical with respect to each other. This is analogous to the requirement of operating on the straight portion of a tube when amplifying.

At one time the writer was convinced that he had achieved the desired result, but further work showed that the principle of circuit two was correct but that the control by the first circuit was not independent of the current in circuit two. Regeneration was out of the question. Some refinements may yet bring results. Mr. Pickard made a crystal oscillate but it was of no commercial value. However, he evidently expects that it may some day be of value, as he is very reluctant to give any information as to the manner in which he achieved it. Fame and fortune await the one who solves this problem.

For the above work a radio potentiometer of 200 ohms may be used for P, a voltmeter from 0 to 1 or 2 volts and a galvanometer that will read from one-tenth to 20 microamperes (millionths of an ampere). A galvanometer of this type can be built by the amateur. The next important question is a detector that STAYS in adjustment.

For this, silicon and pyrites are recom-

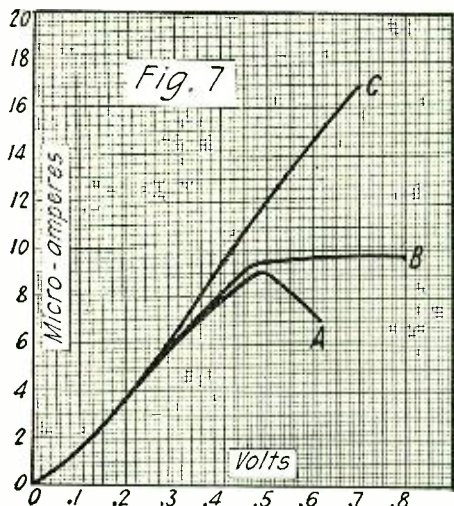

Curve Showing the Rectified Current for Increasing A.C. Voltages for the Three Crystals Mentioned in Fig. 6.

mended for cat-whisker detectors with the zincite-bornite couple most satisfactory of all. Several companies manufacturing radio supplies have this couple in stock. While not as sensitive as the two named above, it requires a rather heavy pressure and is not easily jarred out. The difference in sensitivity is hardly noticeable. The most satisfactory detector stand is pictured in Fig. 9. The design should be followed closely and the smallest threads obtainable used in order to prevent wobbling of the screw. The thickness of the metal at that point may be increased to accomplish this.

As regards the actual explanation of why a crystal shows a change of resistance, little is known. Several theories advanced include the theory of thermo-electric effects at the fine point and all have been practically disproven by G. W. Pierce of Harvard. The most hopeful of all is the theory advanced by Roberts and Adams, of the Geophysical Laboratory, which is briefly as follows: The modern theory of

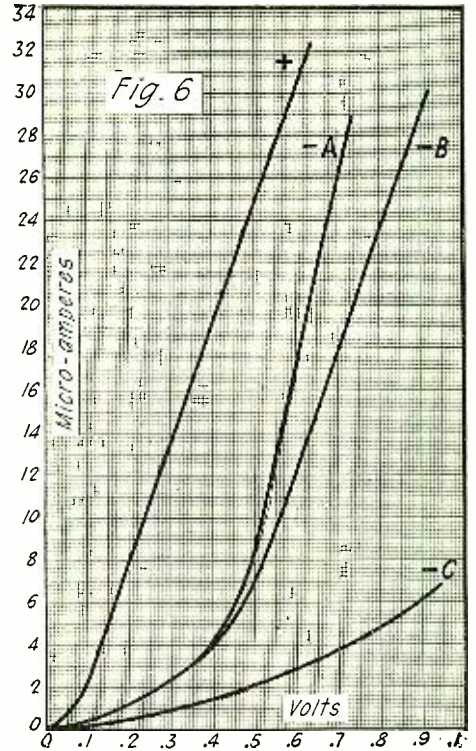

The Voltage-Current Characteristics of a Galena (-C), a Silicon and a Carborundum (-B) Crystal.

atomic structure for galena would allow of spots on the surface composed of only one type of atom, that is, in one case the boundary plane might be all lead atoms. This region would possess presumably an unbalanced electrostatic field and if contact were made with a fine point one might expect an unsymmetrical conductivity curve, the free electrons in the cat-whisker and in the atoms of lead acting a similar role to those in a tube. One objection apparent to this is that the boundary planes referred to above are not regular fracture planes of galena, but occur, if at all, in the rough spots on the crystal and I have observed exceptional sensitivity on very smooth faces of galena. Also carborundum works fine with a point of the crystal pressed against a plate. However, the crystal and atomic relations of carborundum are still undetermined. The most important objection is that crystals when pressed between plates of soft lead show a change of resistance.

The writer has attempted to present the state of advancement in the crystal field at the present time and to stimulate and direct experimentation along that line. Two fields lie open to the experimenter. One is the explanation of the change in resistance which should be left to the research physicist and the other is the problem of amplification, regeneration and oscillation as previously explained.

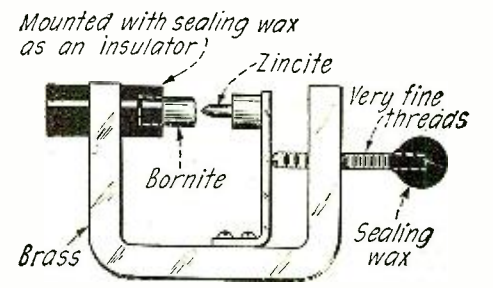

A Very Reliable Type of Detector Stand That Can Be Used with Any Type of Crystal or Crystals.

Outline of the Problem of Radio Control

By OLLE D. ENGSTROM

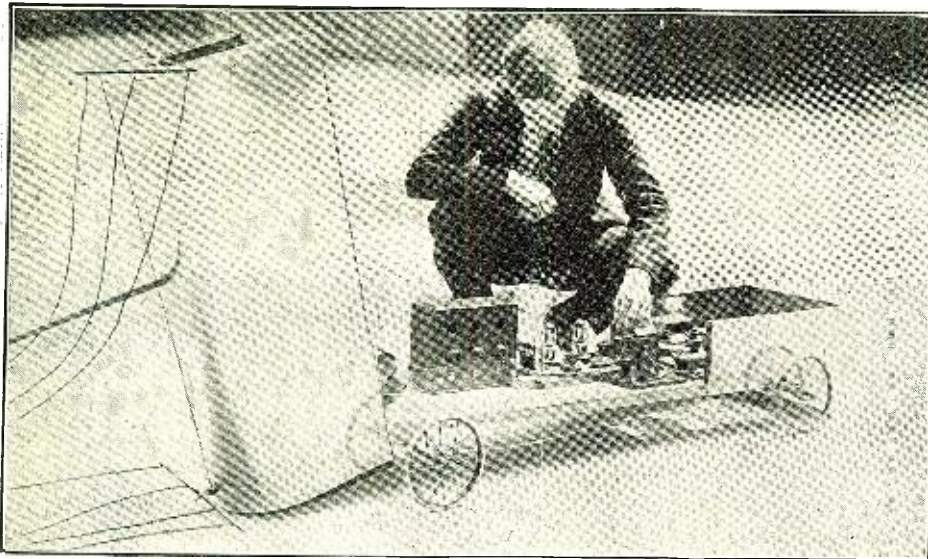

A Photo of Mr. Engstrom and His Radio Controlled Car. The Antenna is of an Inverted "V" Shape and is Mounted Directly Atop the Hood.

RADIO control, although comparatively new, has been used considerably by experimenters and by the Government. Vehicles on land and vessels on water have been made to operate exactly as under direct control, even to the smallest detail. These accomplishments have not been public information and hence much has been guessed at by those interested. There was some data published on the subject prior to the beginning of this work. Some of this information was investigated by the writer and found to be questionable. There was, however, a particularly good paper written by F. W. Dunmore, of the U. S. Bureau of Standards, in the A. I. E. E. Journal on this subject, and data obtained from it is incorporated in this article.

Relays have been operated by wireless telegraph instruments for some years. Their use did not, however, become practical until the birth of the electron relay tube. This tube, in short, is a device which allows the weak incoming signal to control a local source of power. However, the problem of radio control, as the ordinary mind might conceive it, from the above explanation of a vacuum tube, is not so simple. The local source of power that can be handled by one tube is extremely small. The change of current in the local circuit of a single tube receiving set, as occasioned by a strong incoming signal, is only a fractional part of a micro-ampere. This current, although plenty strong enough to operate a sensitive pair of telephone receivers, is far from enough to operate a sensitive relay. The most delicate type of relay constructed today requires a milliampere to operate it. So the problem reduces to this: if a relay is to be used, a circuit should be obtained which will allow the incoming signal to cause a sufficient change in a local current to perform the desired function.

SPECIAL RELAY IS NECESSARY

The possibility of departing from the common type of relay and obtaining something more delicate was well considered. Other devices more sensitive could readily have been obtained or made, but their delicate construction prohibited their use in this capacity. One of the ideas which was scouted was the use of a contact making galvanometer. The outstanding feature of this instrument was its sensitivity to the slightest force and this in turn made its

use unfeasible. The slightest mechanical vibration would suffice to operate the instrument; hence the necessity of a practical relay became apparent.

A relay, in order to be satisfactory for

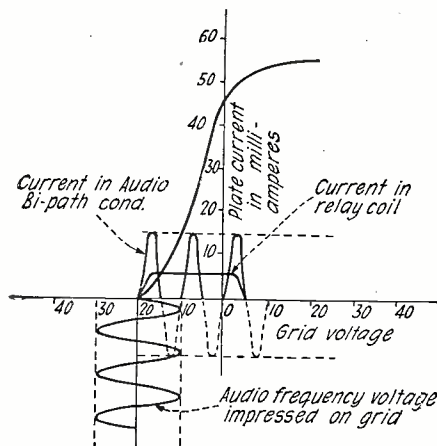

Fig. 2. The Grid of the Relay Tube is so Biased That There is No Plate Current Flowing While the Circuit is Normal. This is Illustrated in the Above Curve.

use in radio control, must be sensitive, rapid and positive in action and simple in adjustment. This requires that the instrument have a large number of ampere turns and extremely light and well balanced parts. The armature must, however, be rigid and its motion in order to give quick action must be small. There must be a certain amount of spring tension in order to eliminate the effect of vibration upon the in-

strument. The air gap between the armature and the pole piece should be small, yet it must not be allowed to touch the iron of the magnet, otherwise residual magnetism will not allow prompt release of the movable element. Once a relay has been constructed the question arises, how can this instrument be made to control the many different actions of a moving vehicle? Many such instruments are in use today and almost seem to be superhuman. Thus, ideas were readily obtainable from surrounding practices. The selector employed in this construction is of private design.

Then there arises all sorts of mechanical troubles in regard to the operation of the different controls. These details, in the construction of the model, could not be made similar to the instruments necessary in the operation of an actual vehicle, as this would necessitate too many complications. However, the ideas used could be adapted and enlarged, unless better ones were employed.

Thus the problem in obtaining practical radio control has been explained. The following matter will explain the theory and details involved.

THE CONTROL CIRCUIT

The circuit which was used is shown in Fig. 1, and uses a relay which is designed to operate on currents of approximately five milliamperes. This circuit is intended to be operated from the output side of any ordinary receiving set with two stages of audio frequency amplification. Thus the power obtained is considerable and when amplified again, a relatively large plate current is obtained.

In Fig. 1, C is an audio frequency transformer, E is a two megohm grid leak, Q is a .0006 M.F. condenser, D is a grid biasing battery of very fine adjustment and was found to be about 40 volts, J is a 160-volt "B" battery. The tubes K were the Western Electric type VT-1; however, any amplifying tube would serve equally well. F and H are each 1-M.F. condensers. T is an ordinary telegraph relay rewound with 12,000 turns of No. 38 S.S.C., B & S gauge enamel covered wire.

PRINCIPLE OF OPERATION

Fig. 2 shows the tube characteristic and the principle made use of. Since a high plate voltage is used, a relatively large "C" battery must be used. The function of this "C" battery is to shift the zero axis of the impressed audio frequency wave to the point on the characteristic curve at which the plate current is zero. Thus normally there is no current flowing through the relay which is in the plate circuit of the particular tubes in question. Now supposing, for purposes of illustration, the impressed frequency had an amplitude of 20 units, and that the negative grid bias was

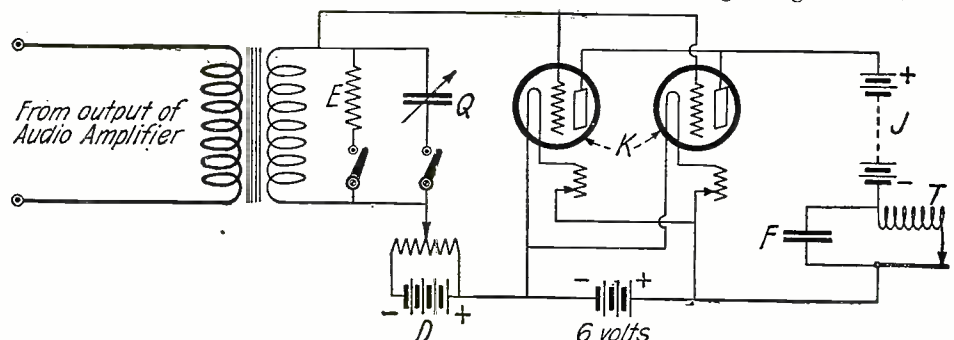

Fig. 1. Diagrammatic Sketch of the Relay Circuit. The "C" Battery D is Made Adjustable by Use of a Potentiometer. The Relay is Controlled by the Flow of Plate Current.

such as to give zero plate current at 30 units. The grid voltage would then fluctuate between -20 and -40 units. However, as the grid was made more negative no effect was obtained in the circuit, but as the grid voltage was reduced to -20 a plate current would flow, having a general shape as shown. Thus a pulsating direct current is obtained through the relay which takes place at the wave-train frequency of the transmitter and suffices to pull the armature over.

It was found necessary to put a 1-M.F. condenser across the relay in order to provide an audio-frequency by-path for the highly inductive winding, thus materially reducing the resistance of the circuit. This circuit, it was found, could be operated by heavy discharges of static, but this was overcome by increasing the negative bias obtaining the condition which is pictured in Fig. 3. Here the effect of the controlling signal is weakened, but the disturbing electro-motive-force is entirely eliminated. Of course this method of eliminating interference can only be used where the directing signal is considerably stronger than the disturbing signal. The axis of the impressed voltage is shifted from -30 to -35, thus if the undesirable voltage has an amplitude of 10 units the signal amplitude being 20, the effect of the disturbance will be to vary the grid voltage from -40 to -30, but no plate current flows at -30 units, so the undesirable influence is lost. The circuit can be made a great deal more selective by using the variable condenser shown distant across the secondary. In this manner distant stations were tuned in, which local stations were working. This tuning is adjusted to the audio-frequency signal and is independent of the carrier frequency or the frequency of the transmitted wave. In other words, this tuning eliminates signals having a different note. Thus several recorders can be connected in series and operated independently by two stations having a different wave train-frequency.

The speed of operation of the relay was as high as 48 contacts per second with a current variation of 10 milliamperes in the plate circuit. With three milliamperes the speed was 27 contacts per second, and at one milliampere the speed was 19 per second. Of course the speed of operation depends, among other things, on the tension of the armature spring. This was adjusted in each of the above cases for the point of best operation. It can be seen from the above data that for all practical purposes the speed of operation of the relay is sufficient.

Sensitivity is one of the main desirable

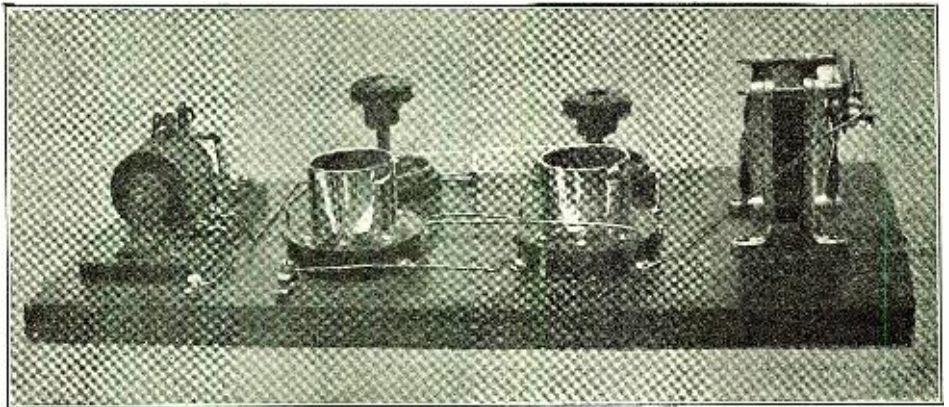

A View of the Relay Control Unit. The Relay is Seen on the Left of the Board.

points in this type of apparatus. Demonstration models have been recently constructed which have been operated by the use of the old coherer detector, but obviously this form of apparatus will only operate when a relatively large amount of power is used within a certain limited radius such

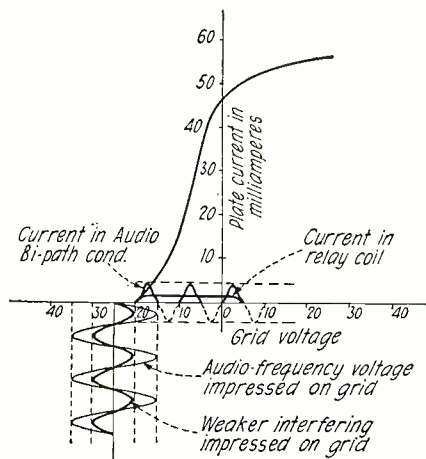

Fig. 3. By Decreasing the Grid Bias, the Chance of the Circuit Responding to Interfering Voltages Was Eliminated. The Effect is Shown.

as a few hundred feet at the most. The instrument used in this investigation will permit operation at long distances. In the preliminary tests performed on the controlling relay itself, it was made to operate on signals of fair audibility from a station in Newark, N. J., a distance of some 12 miles or so by air line. This relay, however, will operate over much greater distances. The circuit was so designed that when 1.3 volts

was impressed across the primary of the control circuit it caused a change of five milliamperes in the plate circuit. In a circuit similar to this one, the relay was caused to operate on signals from Nauen, Germany, while a powerful American station was simultaneously operating. No interference was noticed.

The simplicity of this control system together with its practicability and ruggedness makes it feasible for use in any moving apparatus such as airplanes, automobiles or boats. It can be installed wherever any ordinary receiving set will work. Vibration will not materially effect it, providing the spring on the armature is properly adjusted. The source of power can be obtained from a common storage battery and from high voltage dry batteries. If the apparatus is stationary and is located in the vicinity of an alternating current supply, this can be used in place of the batteries by introducing slight changes.

DETAILS OF CONSTRUCTION

The circuit shown in Fig. 1, for which Mr. Dunmore is responsible, was finally used after much investigation into other possible circuits. The reasons for the choice was, as previously stated, its sensitivity, ruggedness and practicability.

The output of the audio amplifier was put into the primary circuit of an Acme transformer, having a ratio of one to four. The choice of transformers is not particular, the product of any reputable manufacturer being satisfactory. The tubes used were the Western Electric VT-1. Their general characteristics make them good amplifiers and also permit the use of the necessary high plate voltage. Two of these tubes were used in parallel, as shown in the wiring diagram, in order to enable them to handle the power which is relatively large for receiving tubes. The filament temperature was not critical, but was adjusted to its normal value of 1.1 amperes per tube. The grid biasing batteries were obtained variable in 1½-volt steps, but this was not close enough. Finally a potentiometer was shunted across the "C" battery and the required adjustments made. It is highly essential that the potentiometer have a resistance in the vicinity of 5,000 ohms or higher, otherwise the batteries will be extremely short lived.

The relay used in the above circuit was a reconstructed telegraph relay. The core was of soft iron 1¼" long and ¼" in diameter. A bobbin was constructed, the sides of which were 1¼" in diameter, and on this were wound 12,000 turns of No. 38 S.S.C. enamel wire. A lathe should be used in winding this relay, as the job would be extremely tedious otherwise. A revolution counter attached to the machine will give the correct number of turns. In this manner the coil can be wound in about 20 minutes. The armature was mounted in a vertical position, the pivots being at the base. The coil was mounted very close to the armature to increase the sensitivity of the instrument, the separation being only about

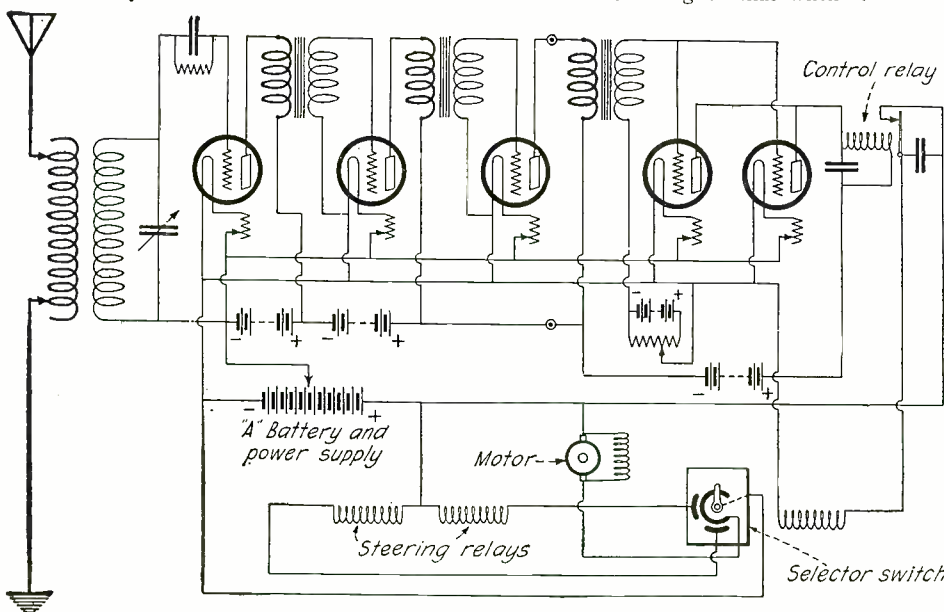
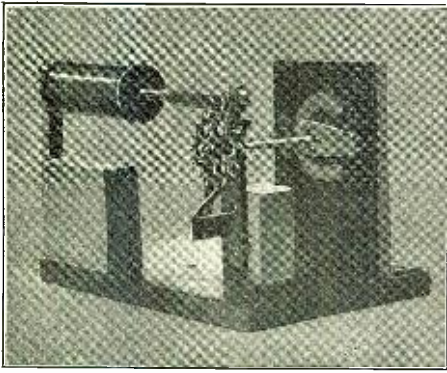

Fig. 4. The Complete Circuit Diagram of the Radio Control System. After the Controlling Waves Have Been Detected by the First Tube, They are Magnified by the Three Audio Amplifiers, Then Impressed on the Last Tubes, Which Control the Relay System.



A View of the Selector Switch.

a thirty-second of an inch. Special stops were mounted on the supports to limit the motion of the armature; the stop on the coil side was made of metal and acted as one of the relay contacts, the other being the armature; the other stop was made of insulating material. In order to have speed of operation of a relay, the motion of the armature must be small and that was adjusted to $1/16$ " in this particular case. Another important consideration under speed of operation is to keep the armature from actually coming in contact with the core of the magnet. Because of the certain amount of residual magnetism in the core, if the armature were allowed to touch it, the release would not be rapid. Thus the contact stop was adjusted so that the distance between the armature and the core was as small as possible without actual contact. The armature spring was a helical type and mounted so as to be capable of adjustment. The spring tension necessary in the relay is of course very light.

THE SELECTOR

The next essential instrument was a selector switch which would in some manner choose the different operations to be performed when desired. Several schemes were considered, but the final form seemed best. The writer considered designing a relay which, upon receiving a certain arranged signal, would immediately close the desired circuit. There were numerous reasons why this could not be installed in the model. The next best idea was to use a progressive control system. By that is meant the moving of a switch through a certain number of degrees of a circle, upon successive impulses. The switch closes the circuits from a common battery to the different relays controlling the desired operations. In this particular model, it was decided that for the sake of simplicity the car would only be constructed to start, stop and steer to the right and left. Of course, it may be understood that if the car can be made to perform the above functions at the command of the operator, it can easily be made to do more, simply by adding more positions on the selector switch.

On the actual switch, shown diagrammatically in Fig. 5, there were eight positions, only four being alive; the others were spacers to avoid the switch jumping directly from one control to the other. The switch consisted of two phosphor-bronze contacts mounted on

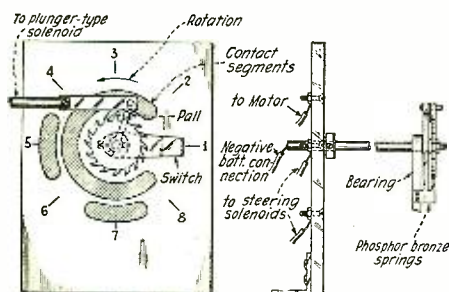

Fig. 5. Details of the Selector Switching System.

the same arm and attached at different radii. The contact nearest the center dragged across a brass segment through three quarters of a revolution. The outer contact touched two small segments in the fifth and seventh positions, the stop position being number one and rotation counter-clock-wise. The switch arm referred to, was mounted on a shaft carrying a ratchet wheel of 16 teeth. In order to rotate the switch through one eighth of a revolution, at each impulse, it was necessary to get a ratchet, the number of teeth of which was divisible by eight.

The next arrangement was to obtain a plunger type electro-magnet and a mechanism to rotate the wheel. A pall was constructed which worked concentrically with the circumference and was connected to the iron plunger by a linkage. Trouble was encountered in making a spring which would be able to return the pall to its starting position and yet not offer a large initial tension to the pull of the magnet. Finally, a long springy piece of phosphor-bronze was brought to bear on the pall. This is better shown in the photograph. The solenoid used was designated as follows: The coil was $2\frac{1}{2}$ " long and 1" in diameter, the core was made of soft iron, $\frac{1}{4}$ " in diameter, and $2\frac{1}{2}$ " long. The size of wire used was No. 24 D.C.C., B & S gauge. After experimenta-

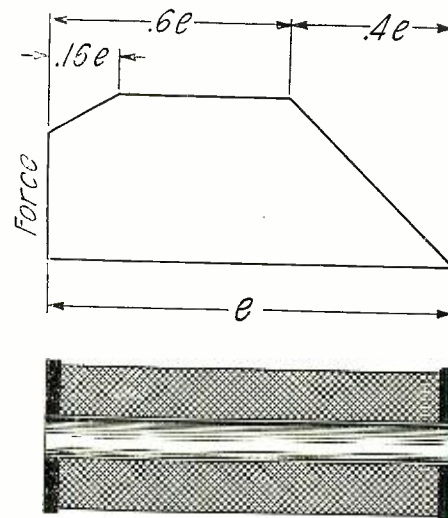

Fig. 6. Showing Graphically How the Pull in a Plunger Type Magnet Varies with the Position of the Core.

tion, the correct number of turns were found to be about 500. This number of turns gave the desired pull and speed on 10 volts. Fig. 6 shows graphically how the pull in a plunger type magnet varies with the position of the core. In order to get a magnet to give the maximum pull desired it is necessary to keep the curve of the diagram in mind. The drawing in Fig. 5, shows the selector switch and the essential parts. Some of the simple details were omitted for the sake of clearness, such as the stops, to limit the motion of the pall and some of the necessary springs and other minor things which insure the reliability of the instrument. All the difficulties in this problem are not perfectly obvious at first sight. One of the big handicaps is the limited amount of power that can be carried on a model. Hence the current that the relay is allowed to draw is limited. This necessarily puts a limit on the power of the magnet. Thus in order to get the instrument to work, it will be necessary to eliminate as much of the unnecessary friction as possible and use only as much friction in the contacts as is compatible with good operation. Then too, the springs used must not be too heavy, or the weight of the moving elements too great. All these different details were carefully considered in this construction and after a good deal of experimenting the switch shown in the photograph was obtained.

STEERING THE RADIO CONTROLLED CAR

The next problem is to effectively steer the car. At first, the possibility of using a special motor and reversing its field was considered but this was set aside mainly because of the limited supply of power. The next idea was to use the driving motor as the steering power also. It was of course obviously necessary to greatly reduce the speed of the motor for steering purposes. The writer tried to think of the best possible way to steer the car, but due to limited time the present method was chosen as the simplest and quickest to construct. It, however, did not have so much bearing on the practical problem of radio control for vehicles because they steer differently. Thus the steering of an actual car would probably be the application of methods now in use. In solving the problem, gear drives and worm drives and other kindred methods suggested themselves, but the friction drives seemed the most logical.

The shaft of the driving motor, revolving about 1,000 revolutions per minute, was continued for about a foot under the body of the car. On this shaft were mounted two small rubber pulleys about 5" apart. Fig. 7 shows a plan view of the apparatus. The pulleys, just mentioned, were given a slight taper of the same degree as that put on the under side of the 5" aluminum pulley, mounted $\frac{1}{8}$ " above them. The degree of the taper can be any small amount. The pulley referred to was mounted on the under side of a brass plate pivoted at one end as shown, and free to move laterally. On the upper side of the plate and attached rigidly to the aluminum pulley is the small steering spool. The latter rotates freely with the pulley. Little wheels, as shown in the diagram, are mounted on the brass plate in order to reduce the rubbing friction between the aluminum pulley and the plate. This particular is essential to successful operation. Now the object was to obtain rotation of the spool in either of two directions by a slight movement, and also to obtain the necessary reduction of the shaft speed.

By studying the accompanying drawings, it can be seen that by a slight movement of the brass plate around its center, the tapered under part of the aluminum pulley will come in contact with a like taper on one or the other of the small rubber pulleys. If in contact with one, it will rotate in one direction and when brought in contact with the other, the opposite rotation is secured. The movement of the brass plate is accomplished by the solenoids shown in the illustration. They are wound on brass tubes $2\frac{1}{2}$ " long whose inside diameter is large enough to accommodate a $\frac{3}{8}$ " soft iron plunger. The ends of the hobbin were made of fibre $1\frac{1}{4}$ " in diameter. The core is 3" long and should be connected to the brass plate by a suitable linkage which will give a free motion. This will readily suggest itself to the constructor. One or the other of the magnets is operated, depending upon which of the two steering contacts the switch arm is resting on, see Fig. 5. Two springs are used to maintain the plate in the

(Continued on page 756)

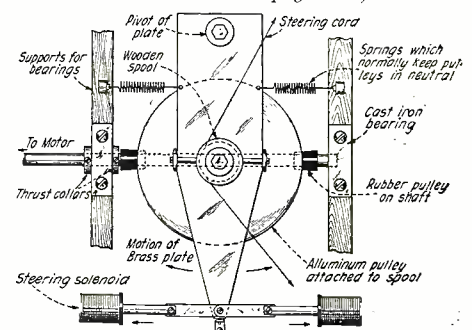
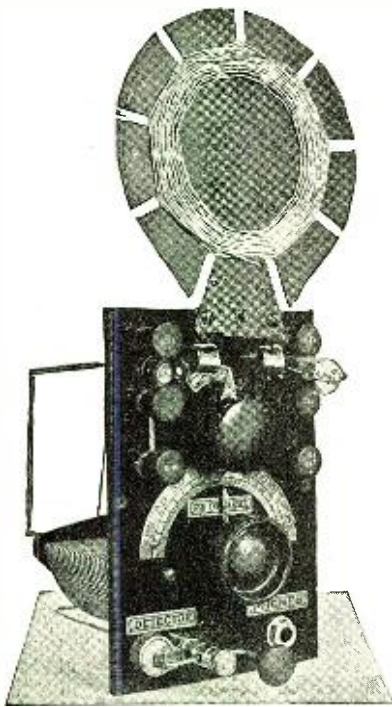

Fig. 7. Details of the Pulley and Solenoid Plungers, Which are a Part of the Selector System.

The Pritchard Universometer

By P. A. PRICE



A Side View Showing How the Coil is Attached to the Top of the Instrument. Various Sized Coils Can Be Plugged in and Out at Will.

THE amateur who dislikes making a wave meter or wave filter because the equipment will be available for nothing else, will find the Pritchard Universometer, designed by Walter S. Pritchard, of Cleveland, Ohio, to be of general utility, remarkably compact, and readily constructed of a few spare parts found usually among the experimenter's apparatus.

A front view photograph of the Universometer is given in Fig. 1, with the circuit shown in Fig. 2. It may be used as:

- (1) Transmission wave meter
- (2) Receiving wave meter
- (3) Series, parallel, or inductive wave filter
- (4) Regenerative tube receiver
- (5) Crystal receiver.

Applying these uses: (1) is a necessity for the C.W. and phone amateur; (2) is of assistance in the designing, calibration and operation of any receiving set; (3) is a life saver for the BCL in congested areas; (4) and (5) serve admirably in their respective fields when the experimenter's regular receiving set is undergoing repairs or rehabilitation or as portable outfits.

Very little apparatus is required, but the set should be of substantial construction so that no variation will occur after calibration. The following material is sufficient for the purpose:

- 1—1/4" x 4" x 6" panel*
- 1—6 binding posts
- 1—43-plate (variable) condenser
- 1—No. 215-A ("N") tube and socket
- 1—8-ohm rheostat (for tube control)
- 1—.00025 (fixed) grid condenser.
- 1—Grid leak (value as required)
- 1—2 1/2-volt, or 4-volt, flash light lamp and socket.
- 1—crystal detector mounting
- 1—(or more) honeycomb, duo lateral or spider web coils with single coil mounting.

Any dry cell tube may be substituted for the No. 215-A tube, and a thermogalvanometer (hot wire ammeter) may be used

*A larger tube or coil mounting than those used will require a larger panel.

in place of the flash light lamp. The size of the honeycomb or spider web inductances will be discussed in a later paragraph. In the set shown, a spider web coil with two Fahnestock clips for terminals, and a mounting consisting of two brass L-hooks, were used, since considerable panel space was saved thereby.

If the experimenter has access to a transmitting set giving a number of different wave-lengths, the Universometer may be calibrated in the following manner: Referring to Fig. 2, strap 1 is removed and strap 2 connected. No external connections are made, but several inductances (VI) should be available, one of 18 to 20 turns for a range of 150 to 300 meters, and others of say 50, 75 and 125 turns for higher wave-lengths. In the set described, 20 turns gave a range of 150 to 300 meters.

The coil, mounted and connected in the set, is brought into inductive relation (placed alongside) to the antenna inductance of the transmitting set and the lamp will glow with greater or less brilliancy. The variable condenser is set to obtain a maximum glow and the particular location of the condenser dial is marked as for this particular wave-length. If a hot wire ammeter is connected (as shown by the dotted lines) the lamp is removed, but the condenser is used as before, and the value of the ammeter reading is taken as a basis for calibration.

An ordinary 2 1/2-volt, or 4-volt, flash light lamp will serve for the meter, such as is used in the small 2- or 3-cell flash

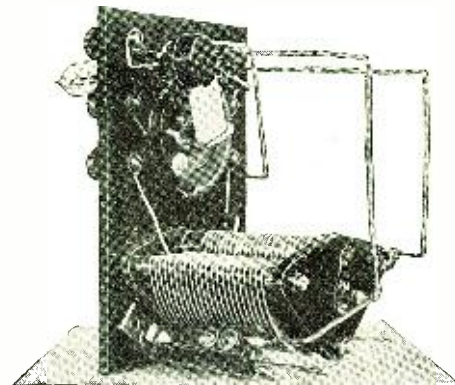

Rear View of the Universometer. The Round Metal Case at the Top Incloses a Variable Grid Leak.

lights. This lamp should operate on 100 milliamperes (1/10 ampere) and, with sockets, are purchasable at any store handling flash light supplies. If a hot wire ammeter is used, it should be suitable for use on a similar value (1/10 ampere) of current.

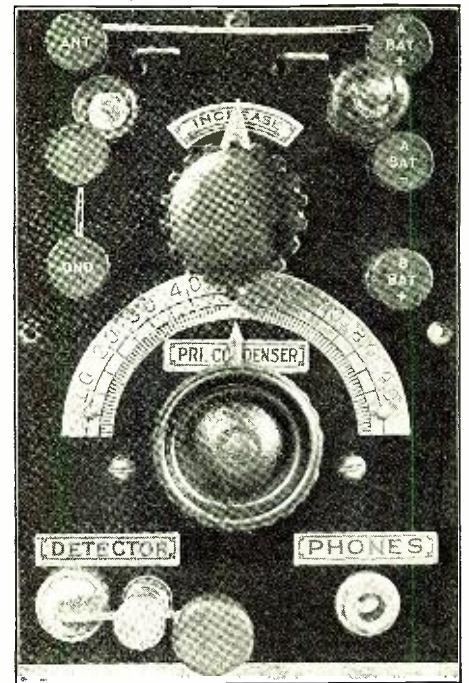

Front View of the Universometer Clearly Showing the Respective Positions of the Units. This Instrument Can Be Put to a Number of Uses.

If a transmitting set working on the desired wave-length range is not available for calibration, the experimenter may calibrate the Universometer by the following method: Strap 1 is removed and strap 2 left in place, with the telephone receivers plugged into the receiver jack and the crystal detector in operative position. No other external connections are made.

The experimenter's regular receiving set is tuned for maximum clearness and volume with some broadcasting station whose wave-length is known. The inductance of the Universometer is then brought into inductive relation to the tuning unit of the regular receiving set and the variable condenser (of the Universometer) is operated to secure maximum reception with the crystal detector and receivers of the meter. The setting of the condenser dial is then marked and other stations, having different wave-lengths, are secured for other settings. It is obvious that, with accurate calibration, the wave-length of any incoming signal can be immediately identified by the reception at any particular setting of the condenser dial.

A more accurate, but more difficult, procedure is the "resonance click" method. (Continued on page 796)

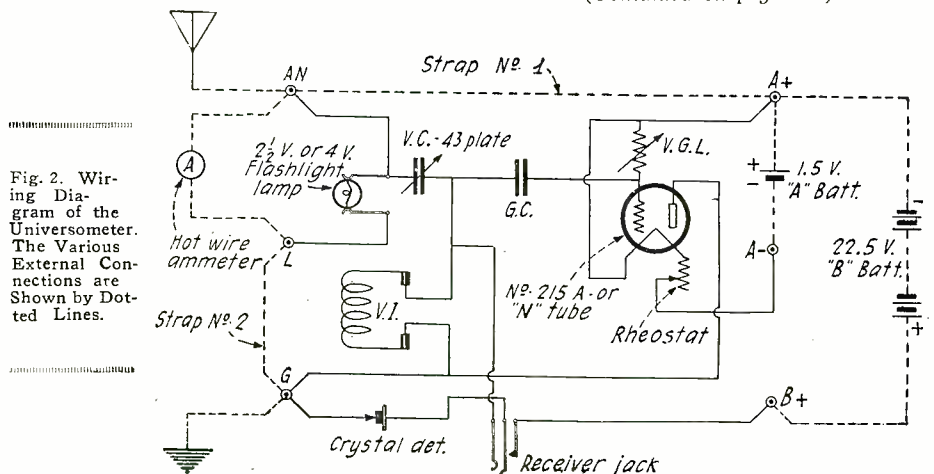

Fig. 2. Wiring Diagram of the Universometer. The Various External Connections are Shown by Dotted Lines.

Awards of the \$50 Radio Wrinkle Contest

First Prize

AN EXCELLENT INDUCTANCE SWITCH.

By C. A. LINDENMEYER

One of the sore eyes of a radio receiving set is the inductance switch. Not only are they unattractive but usually due to the man-

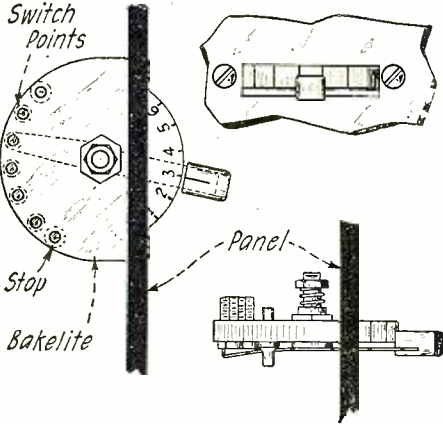

A Switch of This Type is a Great Space-Saver and Has a Pleasing Appearance as Well. The Switch Points Are Mounted Underneath the Piece of Insulation so That Dust Cannot Collect Upon Their Surfaces.

ner in which they are mounted, they do not make a clean contact at all times. The type of inductance switch described herewith is very convenient, and improves the appearance of any panel as it does away with the points and blade on the outside. It also cuts down body capacity as the points are behind the panel, which probably will be shielded, and it is also at right angles to the operator's hand.

The drawing shows clearly how this switch is constructed. First a piece of bakelite is cut to the required size for mounting the switch points and stops. A small switch arm is cut from a piece of spring brass or other suitable material and a small piece of bakelite of the same thickness as the piece used for mounting the switch points, is secured to the end of the arm. The bushing from a common inductance switch and a small bolt sum the necessary parts. The numbers and hair-lines are scribed on the extended piece of bakelite with a sharp pointed steel tool. These may be filled in with any coloring material desired. The colored crayons sold on the market for use with Eversharp pencils, are made of a soft material, and may be utilized. The color red for example, gives a very pleasing appearance.

Second Prize

TUNED IMPEDANCE AMPLIFICATION.

By A. L. MUNZIG, 62J

I would like to present to the readers of RADIO NEWS, a novel means for tuned impedance control, for radio frequency amplification. Tuned impedance offers twice the amplification that transformer coupled types can give, so why not use it?

Obtain a Remler or other variometer and take it completely apart, without disturbing the molded windings. Separate the two stator windings and the two halves of the rotor winding. Bring out leads through small holes drilled in the rotor form. Assemble and connect one side of the stator winding in series with the corresponding half of rotor. Do the same with the corresponding half of rotor. Do the same with the remaining stator and rotor halves. Thus we have two variometers in one, that change their mutual inductance simultaneously, thereby doing

Prize Winners

FIRST PRIZE \$25

An Excellent Inductance Switch

By C. A. LINDENMEYER,
2116 3rd Street,
Peru, Illinois.

SECOND PRIZE \$15

Tuned Impedance Amplification

By A. L. MUNZIG,
1017 Tribune Street,
Redlands, California.

THIRD PRIZE \$10

An Efficient Inductance

By J. M. FOX,
347 Yurge Street,
Toronto, Canada.

away with an extra control, allowing two stages of radio frequency to be available, minus several critical adjustments.

By shunting a small fixed condenser across each variometer, (they must be of the same capacity) they can be made to function as radio-frequency tuned-impedance transformers on amateur and broadcast wave-lengths. The value of the capacity used depends on the waves to be covered.

Some of the readers may be dubious about

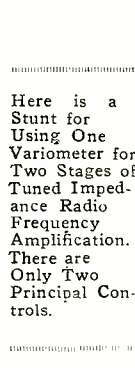

the practicability of this "stunt," due to the fact that both tuned impedances are in too close a proximity to each other. However, this is an advantage and not a detriment to the efficient operation of the amplifier.

Connections for two stages of tuned radio frequency amplification are shown in Fig. 1.

Third Prize

AN EFFICIENT INDUCTANCE.

By J. M. FOX

The inductance described herein consists of a coil wound upon six bakelite strips, which are mounted edgewise in two wooden end pieces.

These end supports are made by boring six 2" holes at equal distances around a 6" circle. The best material to use for this purpose is 3/4" oak. By putting two boards together in a vise both ends may be cut at once. After the holes are bored the waste wood is cut away with a keyhole saw. This will leave six "spokes" in each wooden end, each of which must be slotted to hold the strips of bakelite. The strips have a 1/4" hole bored 3/8" from each end so that they can be bolted securely in their slots.

The bakelite pieces used are 1" wide and 10" long. Before assembling, the

strips should be put in the vise and slotted every 3-16" with a hacksaw.

After the framework is assembled, the wire is wound carefully in the slotted edges of the bakelite. No. 10 hard drawn copper wire is ideal for this purpose, but if this is not available No. 8 soft copper will do.

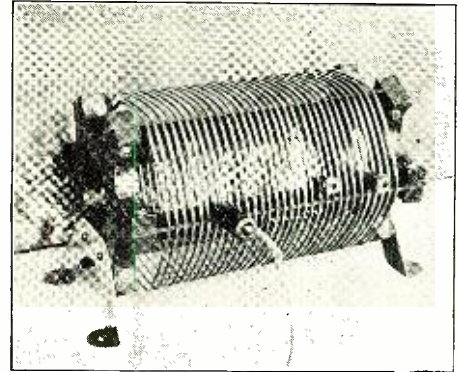

A C.W. Inductance of This Form Has Few Losses in Comparison to Types Wound Directly on Solid Insulating Tubes.

Suitable clips may be made very easily by attaching a 30 ampere switch jaw to the shell of a Walger fixture connector.

The unit may be mounted in any position by means of feet cut from sheet brass as shown.

The inductance has a pleasing appear-

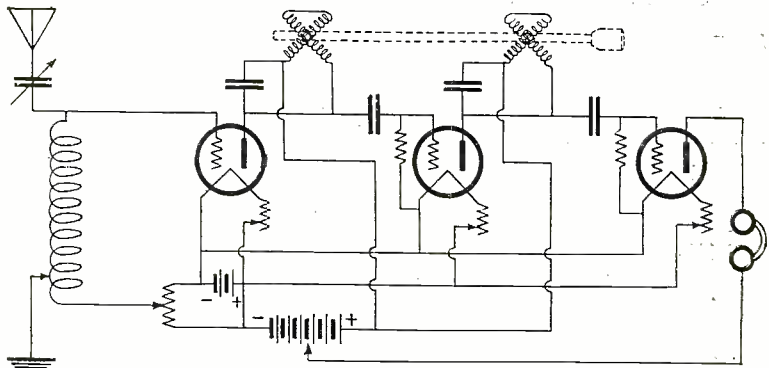

ance and most of the material mentioned can usually be found around the experimenter's workshop.

THE CHEAPEST AND SIMPLEST REGENERATIVE RECEIVER

The novice is always on the look-out for a simple and cheap receiving set, which is efficient in operation. Here is what is believed to be the best in this respect ever described. For the receiver the following parts are re-

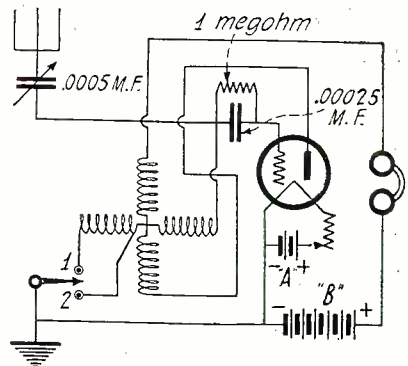

By Breaking the Connection From Rotor to Stator, Any Variometer Can Be Adapted to This Circuit. The Rotor Coil Functions as the Tickler.

quired: One variometer; one 23-plate variable condenser, with vernier; one 1½" switch lever; two contact points. The usual vacuum tube and its accessories fill the rest of the bill. With the usual amateur antenna, this receiver will easily respond to transmitters operating on wave-lengths from 175 up to and including 500 meters. The accompanying sketch explains how it is done. First, single connections are brought out from the two outside windings of the variometer, so that they can be brought out to the two contact points. The leads from the inside or rotor coil of the variometer are connected in the plate-circuit of the vacuum tube, thus converting it into a tickler coil. Regeneration is controlled in the usual manner, by adjusting the rotor coil. For reception on the lower wave-lengths, the switch arm is placed on the contact point marked 1, and on contact point 2 for the higher waves. This is a good stunt and well worth trying.

Contributed by Ray Dio.

A NOVEL LOOP AERIAL

Although a loop aerial is small when compared to an outdoor antenna it is quite a cumbersome object to have in a room. It requires considerable space in order that it can be swung freely in any direction desired.

The loop aerial shown in the accompanying illustration is minus the above mentioned disadvantages. It is composed primarily of a window shade A upon which is wound the

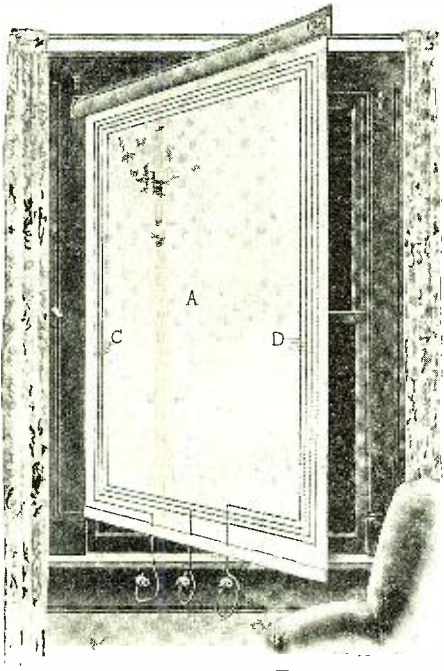

Wind Your Loop Aerial on the Shade and Save Space. It is Easily Done and if Flexible Wire is Used the Shade Can Be Rolled Up.

wires C which are fastened to the shade by stitches D. The roller and support B are free to swing out from the window frame by employing a small hinge E at one end. The loop connections are led to binding posts mounted either under the window sill or on the lower portion of the shade. In order that the shade can roll up freely it is advised that flexible stranded wire be used for the loop proper.

Contributed by B. J. T.

WIRE FOR CONSTRUCTING THAT LOOP

The radio fan with limited means, who desires a loop aerial is sometimes up against it because of the high price of such apparatus. Still, as long as necessity is the mother of invention, and as long as we have scrap heaps, the fan can at least rig up a substitute for that which he desires. Expensive stranded, or ribbon wire is de-

sirable for use on a loop, and if the experimenter will go to a Ford garage he can get an old Ford magneto field coil for little or nothing. On this field is wound about 200' of copper ribbon wire, ¼" wide, in 16-foot lengths. This kind of wire is said to be far superior to ordinary wire for aerial purposes, owing to the increased surface it gives to the flow of the radio frequency currents.

Ribbon wire may also be used to shield panels, connect up your set, and short pieces may be used as connecting links, or battery connectors; therefore, a roll of it should prove a valuable addition to the radio experimenter's hope chest.

Submitted by Glen. F. Stillwell

**Stop! Look!!
Listen!!! Vote!!!!**

ON Saturday evening, November 24, you will have the opportunity to cast your **FIRST RADIO VOTE**. Between the hours of 10 and 11:30 P. M. the 71st Regiment Band, in conjunction with a number of other well known artists, will broadcast from "WJZ," New York, the twelve best selections submitted in the **RADIO NEWS' \$300.00 RADIO MUSIC CONTEST**. These twelve compositions were selected by the judges of the contest as the twelve best numbers submitted. **RADIO NEWS** maintains that music can and will be popularized by radio. We want you to decide by popular vote which of these selections you like best, so that the prizes may be awarded to the most popular.

Cast your vote on a postal card addressed to **RADIO NEWS**. H. Gernsback, Editor of **RADIO NEWS**, will be master of ceremonies and we hope that all those within range will tune in to "WJZ" on November 24, and take the trouble to cast their first

Vote By Radio

A DUO-LATERAL OR PANCAKE COIL MOUNTING

It is customary to mount duo-lateral and pancake coils on the front and outside of

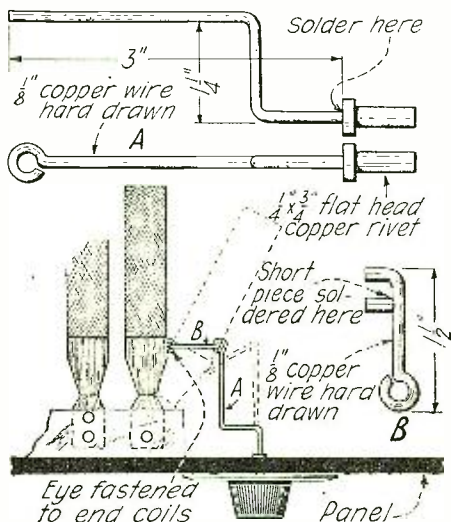

A Clever Arrangement for Varying the Coupling Between Inductances. It will Stay Put at Any Adjustment.

cabinets. This results in a somewhat clumsy appearance of the apparatus and also leaves the coils continually exposed to the capacity effects of the body when tuning. By the simple arrangement shown, it is possible to place these coils inside the cabinet where they can be efficiently shielded in the same manner, and their exact position controlled and determined by dials mounted on the front panel. As the tops of practically all cabinets are hinged, coils can be changed so as to work on different wave-lengths with practically the same ease as when the old style mounting was used. The accompanying sketches, showing the manner of construction, are self-explanatory.

Contributed by A. A. St. Aubin.

AN UPRIGHT AERIAL.

An upright aerial of the type shown in the drawing, is a worthwhile addition to any receiving or transmitting set, and is particularly convenient where but little space is afforded for the erection of an antenna system. When used outside it cannot be knocked down by heavy storms, especially during the winter months when ice covers the wires and gives them additional weight. It is well known that a vertical aerial is the best type of collective agency that can be used in conjunction with a receiving set, and is also well adapted for transmission purposes. It has considerable capacity due to the fact that it is composed of a number of wires in close proximity to each other.

This type of aerial is very easily con-

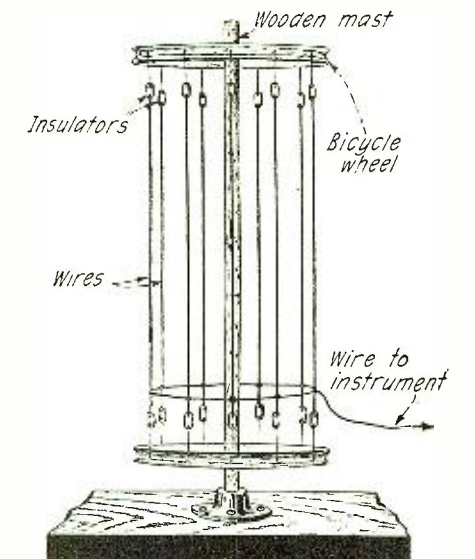

An Aerial of This Type is Satisfactory for Both Reception and Transmission Purposes. It is Very Convenient Where Space is a Factor.

structed, consisting simply of two bicycle wheels bolted at their centers to a wooden or bamboo pole of sufficient diameter to guarantee stability. The two bicycle wheels should be mounted about ten feet apart. The method of assembling is clearly shown in the accompanying illustration. Small insulators should be fastened at intervals along the peripheries of each wheel and the wires suspended between them. The lead-in, as shown is taken from the lower portion of the aerial and led to the set. This type of aerial can of course be used very successfully in-doors.

Contributed by William E. King.

DETECTOR AND AMPLIFIER SUPPLIED WITH A. C.

Ever since I read Mr. Reed's article on A. C. for V. T. filament lighting I have tried all of the like articles that have appeared in this magazine, and have made some improvements myself. It is the use of a choke coil and condenser besides the potentiometer that cuts out the A. C. hum.

(Continued on page 756)



**APPROVED
RADIO
NEWS
LABORATORIES
1922**

RADIO NEWS LABORATORIES



Apparatus Awarded Certificates

LEICH HEAD-SET
The type 1B 2,000-ohm head-set manufactured by the Leich Electric Co., Genoa, Ill., is of the uni-polar type, employing one electromagnet which acts on the center of the diaphragm, the magnetic flux passing through the diaphragm to an iron ring on which it is clamped and from the ring through a permanent magnet and back to the center pole. The impedance of the



double head-set at 1,000 cycles is approximately 23,000 ohms. The phones were found very good for broadcast reception.

Arrived in excellent packing. AWARDED THE RADIO NEWS LABORATORIES CERTIFICATE OF MERIT NO. 244.

LEICH RADIO PLUGS
These plugs are well insulated, of good mechanical design, and are easily attached to telephone cord tips. There are two types, 60C and 61C, one for use with one pair of phones or a loud speaker, and the other for connecting two phones or loud speakers in parallel. The binding posts, accommodate any



type of cord terminals. These plugs are manufactured by the Leich Electric Co., Genoa, Ill.

Arrived in excellent packing. AWARDED THE RADIO NEWS LABORATORIES CERTIFICATE OF MERIT NO. 245.

LEICH RADIO JACKS
The salient features of the Leich Electric Company's jacks are their small size and accurate mechanical design. The plug, on entering the jack, does not short circuit the two foremost contact springs, as is the case with many jacks. Three types, 38A, 38B, and 38D were submitted consisting of single and double jacks.

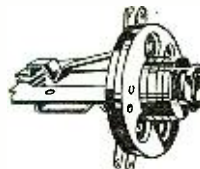

Arrived in excellent packing. AWARDED THE RADIO NEWS LABORATORIES CERTIFICATE OF MERIT NO. 246.

PEP-ITE RADIO CRYSTALS
The Pep-ite detector crystals are manufactured by the Ertco Laboratory, 1413 Washington St., Houston, Texas, and are furnished both mounted and unmounted. They have a rough surface, easily hold contact, and are very sensitive. Each crystal is supplied with a contact wire, with directions for using.

Arrived in excellent packing. AWARDED THE RADIO NEWS LABORATORIES CERTIFICATE OF MERIT NO. 247.

MILLION POINT MINERAL
These detector minerals, furnished in their crude or unmounted state by the Million Point Mineral Co., of 247 S. Central Avenue, Los Angeles, Cal., are a very hard and shiny brittle substance. They are very sensitive over their entire surface and easily hold adjustment.

Arrived in excellent packing. AWARDED THE RADIO NEWS LABORATORIES CERTIFICATE OF MERIT NO. 248.

THORDARSON VARIABLE CONDENSER



A 23-plate variable condenser with vernier, knob, and dial of unusual construction is shown in the illustration. This condenser is manufactured by the Thordarson Electric Co., 500 W. Hudson Street, Chicago, Ill. It is very efficient electrically and is of durable mechanical construction. The dielectric loss resistance at 1000 cycles is only 76 ohms. The capacity range is from 24.35 to 475.31 M.M.F.

Arrived in excellent packing. AWARDED THE RADIO NEWS LABORATORIES CERTIFICATE OF MERIT NO. 249.

THORDARSON AMPLIFYING TRANSFORMER
The Thordarson shielded low ratio (3 1/2 to 1) audio frequency amplifying transformer has an exceptionally flat characteristic curve and gives high voltage amplification.



Amplification below 600 cycles per second, where the majority of transformers fail, is very good. The terminals are marked on the celluloid name plate. The illustration clearly shows its compactness.

Arrived in excellent packing. AWARDED THE RADIO NEWS LABORATORIES CERTIFICATE OF MERIT NO. 251.

THE BRADLEYSTAT
A universal vacuum tube filament control rheostat that may be used with any detector or amplifier tube now on the market is shown in the illustration. This rheostat, which is of the carbon compress on type, is manufactured by Allen-Bradley Co., Milwaukee, Wisconsin. There are two sections of carbon discs which are compressed by the knob. Three terminals make it possible to use either section alone, or the two in series or in parallel. When connected in series, a range of from .9 to 60 ohms was obtained with three turns of the knob.

Arrived in excellent packing. AWARDED THE RADIO NEWS LABORATORIES CERTIFICATE OF MERIT NO. 252.



SERIES-PARALLEL SWITCH
A very simple series-parallel switch that requires very few connections for its use is shown in the illustration. This switch is manufactured by the Marvel-Switch Co., 28 West 25th Street, New York City. Only four connections are employed. Its main use is for connecting the antenna condenser in series or parallel with the tuning coil, thus increasing the wavelength range of the set.

Arrived in excellent packing. AWARDED THE RADIO NEWS LABORATORIES CERTIFICATE OF MERIT NO. 253.

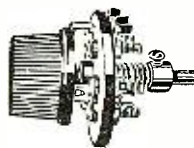

DURATEX DETECTOR
As shown in the illustration, this permanent detector fits the standard grid leak base. The sample submitted for test by the Erisman Laboratories, Washington Heights Bldg., 168th St. & Mitchell Sq., N. Y. C., was found very sensitive.

AWARDED THE RADIO NEWS LABORATORIES CERTIFICATE OF MERIT NO. 254.

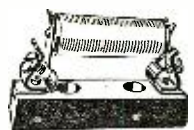

GREWOL DETECTOR
A permanent crystal detector arranged for front panel mounting, so that its adjustment can easily be changed if necessary, is shown in the illustration. The crystal is enclosed in a glass tube making it dust proof and plainly visible. This

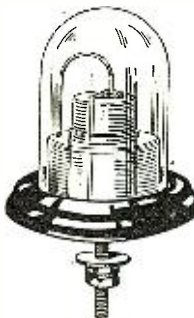

detector was found very sensitive and permanently held its adjustment. It is manufactured by the Randell Wireless Co., 9 Central Ave., Newark, N. J.

Arrived in excellent packing. AWARDED THE RADIO NEWS LABORATORIES CERTIFICATE OF MERIT NO. 255.

SPAGHETTI INSULATION
Insulating and wiring radio sets is greatly simplified with the use of the flexible varnished tubing manufactured by The Acme Wire Co., of New Haven, Conn. This tubing is very flexible and does not harden with age. It is made to fit many sizes of wire, but the size for a No. 14 wire seems to be the most popular. The tubing is made in many colors, such as red, brown, green, black and yellow, the idea being to use different colors for wiring different circuits, thus simplifying the following up of connections. It is a very good insulating material.

Arrived in excellent packing. AWARDED THE RADIO NEWS LABORATORIES CERTIFICATE OF MERIT NO. 256.

SYNTHETIC DETECTOR MINERALS

Several samples of synthetic detector minerals were submitted by A. P. Aylesworth, 637 11th Ave. West, Calgary, Canada, all of which were found very efficient. Each is of a bluish-gray color and has a rough surface, so that the "cat whisker" contact is not easily jarred out. They are mounted in metal and fit the standard 1/2" detector cup.

Arrived in excellent packing. AWARDED THE RADIO NEWS LABORATORIES CERTIFICATE OF MERIT NO. 257.

GENERAL RADIO POTENTIOMETER

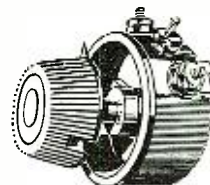

A smoothly running potentiometer that occupies small space is shown in the illustration. This instrument, No. 301, is manufactured by the General Radio Co., 11 Windsor St., Cambridge, Mass. It is of 200 ohms resistance and is of very accurate mechanical construction, insuring proper electrical contact between the lever arm and resistance wire.

Arrived in excellent packing. AWARDED THE RADIO NEWS LABORATORIES CERTIFICATE OF MERIT NO. 258.

QUICK CONTACT CRYSTALS
Little time is lost looking for a sensitive spot on these detector crystals, which are manufactured by Roland Brownlie, Mfr., 24 Saunders Street, Medford, Mass. They have a rough, sparkling surface which is very sensitive all over and the "cat whisker" contact is not easily destroyed. They are mounted in metal and fit the standard 1/2" detector cup.

Arrived in excellent packing. AWARDED THE RADIO NEWS LABORATORIES CERTIFICATE OF MERIT NO. 259.

CUTLER-HAMMER RHEOSTAT
This 30-ohm rheostat, designed for use with dry cell tubes, is of excellent mechanical and electrical construction. The arrangement is such

that positive electrical contact is maintained between the resistance wire and the contact spring, which is mounted in such a manner that the instrument is smooth running and causes very little wear on the resistance wire. It may be mounted on any panel up to 3/4" thick. This rheostat is manufactured by the Cutler-Hammer Mfg. Co., Milwaukee, Wisconsin.

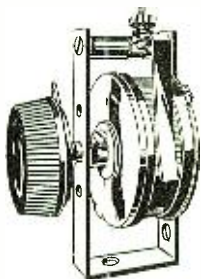

Arrived in excellent packing. AWARDED THE RADIO NEWS LABORATORIES CERTIFICATE OF MERIT NO. 260.

RADJO PERMANENT DETECTOR

This permanent crystal detector has the advantage over many permanent detectors in that the adjustment can easily be changed should it become necessary. The rectifying action takes place at a comparatively heavy contact between two crystals inside of the dust-proof glass tube. It is manufactured by the Harris Laboratory, 26 Cortlandt Street, New York City.

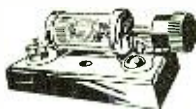

AWARDED THE RADIO NEWS LABORATORIES CERTIFICATE OF MERIT NO. 261.

GENERAL RADIO TRANSFORMER

Quality of radio music requires the use of carefully designed audio frequency amplifying transformers, of which the one shown in the illustration is very good. This transformer, No. 231-A, is compact in size and can be mounted in any position. The characteristic curve is fairly uniform, insuring a minimum of distortion. This instrument is



manufactured by the General Radio Co., 11 Windsor St., Cambridge, Mass.

Arrived in excellent packing. AWARDED THE RADIO NEWS LABORATORIES CERTIFICATE OF MERIT NO. 262.

GENERAL RADIO CONDENSER

The General Radio Company's variable condensers are noted for their low power losses and accurate capacity settings. The metal dial is marked in micro-microfarads as well



as the usual 100 divisions. A gear arrangement operated by the small knob serves for fine capacity adjustments. Low losses are obtained by using the best hard rubber as

insulating material. A capacity range of from 25.08 to 507.95 M.M.F. and a dielectric loss resistance of 146 ohms at 1000 cycles were obtained on the 247-E condenser.

Arrived in excellent packing. AWARDED THE RADIO NEWS LABORATORIES CERTIFICATE OF MERIT NO. 263.

GENERAL RADIO RHEOSTATS

These rheostats, like the General Radio Company's potentiometers, are of accurate and durable mechanical construction. The 214-A 20-ohm rheostat is 3" in diameter and safely carries a current of 3/4 amperes. It was tested for four hours at 1 ampere. The smaller rheostat, 13 1/4" in diameter, has a resistance of 25 ohms. The larger one is shown in the illustration.

Arrived in excellent packing. AWARDED THE RADIO NEWS LABORATORIES CERTIFICATE OF MERIT NO. 264.



HOME-BUILT TUNER

This tuner comprises primary and secondary windings with fixed coupling on the outside tube and a tickler winding on the rotor. The loose coupling between primary and secondary coils and the fact that the windings are of "Litz," make tuning highly selective. As no taps are used, the instrument is very convenient to install and operate. A wave-length range of from 155 to 500 meters was obtained with a .00049-mfd. variable condenser connected across the secondary coil. This tuner is manufactured by "Home-Built" Radio, 427 Walnut St., Philadelphia, Pa.

Arrived in excellent packing. AWARDED THE RADIO NEWS LABORATORIES CERTIFICATE OF MERIT NO. 266.



"AMERTRAN" AUDIO FREQUENCY TRANSFORMER

This transformer, which is manufactured by the American Transformer Company, 178-182 Emmet St., Newark, N. J., was found to have an exceptionally flat characteristic curve, as well as a high amplification factor. With the primary voltage constant, the secondary voltage rises rapidly, as the frequency is increased from zero to 630 cycles per second, and then remains



constant as the frequency is increased to 6,000 cycles. As shown in the illustration, this transformer is of excellent mechanical construction.

Arrived in excellent packing. AWARDED THE RADIO NEWS LABORATORIES CERTIFICATE OF MERIT NO. 218.

Radio Trade News

By L. A. NIXON

NOT only will this be another radio Christmas, and a real radio year, as the sloganists in the radio trade are putting it, but it will be a loud speaker year.

A recent survey made by this organization shows that the number of manufacturers of loud speakers is increasing faster than any other list of manufacturers in the industry. No less than three of the leading organizations in the industry have already announced new design loud speakers, while half a dozen other leaders have new speakers in course of perfection. While each engineer promised new peaks of perfection, none of the speakers viewed thus far offer any radical departure from present types, but are rather improved and refined articles of the types and styles already popular.

After a summer wherein business in the retail radio stores refused to fall off, as expected, the radio industry faced a fall season with practically clean shelves in the retail stores and very low stocks in the hands of jobbers.

Radio chain store operators and bigger buyers had contracted for fall goods and manufacturers were busy with these orders for quite a period in the early fall. The individual buyer, jobber or retailer, had to depend entirely on the stocks manufacturers had built up for them, and in the case of many products the stocks held by the makers were rapidly cleaned out and deliveries began to lag. By the time this appears in print it will not be surprising to see four weeks the standard delivery time in almost every popular article.

While this shortage of quick moving goods will have a temporarily depressing effect on the retailer and may bring about a little spurt in business, it is felt that the result will be for the betterment of the trade, as retailers and jobbers will learn more and more to anticipate their wants, making conditions better for the manufacturer and permitting of greater economies in factory operation.

WITH this month's issue, we are starting this new Department of interest to the trade. We have felt for some time that RADIO NEWS should have such a department for the reason that many people have written to us asking for it. This, of course, is only the beginning, and if the Radio Trade News, which we give herewith, is not just exactly what is wanted, we are open to suggestions. If you will kindly write, addressing Editor, Radio Trade News, we shall be glad to run only such material as is of interest to the majority.

It is interesting to note that factories producing items introduced for the first time the past summer are working overtime and allotting goods to their trade in very small shipments. Other outstanding examples of factories that are busy are those producing articles that have been heavily advertised in the last few months. From these condi-

tions the answer may be drawn that the radio public might have bought considerably more this past summer if they had been asked.

Retailers in many sections complained for a time at the unloading at bargain prices of discontinued lines, but once the sales were started the complaints simmered down as the ultimate result was increased interest on all sides. A survey of a number of the leading makers of complete sets shows that there can be little possibility of any more such sales. Practically every set maker is making plans for a big holiday trade, and it is expected that consumers who want their favorite sets will have to place their orders earlier for radio apparatus than for anything else.

Retailers throughout the country will soon begin a campaign for *National Radio Week* which will be held November 25 to December 1. It is likely that the idea of "do your holiday buying early," will be pushed in this campaign.

The falling off in the applications for new broadcasting stations as noted by the Department of Commerce is interesting to the trade, but it is felt that the present stations increasing their hours on the air, and the improved quality of the programs, will tend to give the public even better programs, month after month, although it is possible that the number of active stations will decrease slowly until it reaches the proper level.

(Continued on page 800)



THIS Department is conducted for the benefit of our Radio Experimenters. We shall be glad to answer here questions for the benefit of all, but we can publish only such matter as is of sufficient interest to all.

1. This Department cannot answer more than three questions for each correspondent.
2. Only one side of the sheet should be written upon; all matter should be typewritten or else written in ink. No attention paid to penciled matter.
3. Sketches, diagrams, etc., must be on separate sheets. This Department does not answer questions by mail free of charge.
4. Our Editors will be glad to answer any letter, at the rate of 25c for each question. If, however, questions entail considerable research work, intricate calculations, patent research, etc., a special charge will be made. Before we answer such questions, correspondents will be informed as to the price charge. You will do the Editor a personal favor if you will make your letter as brief as possible.

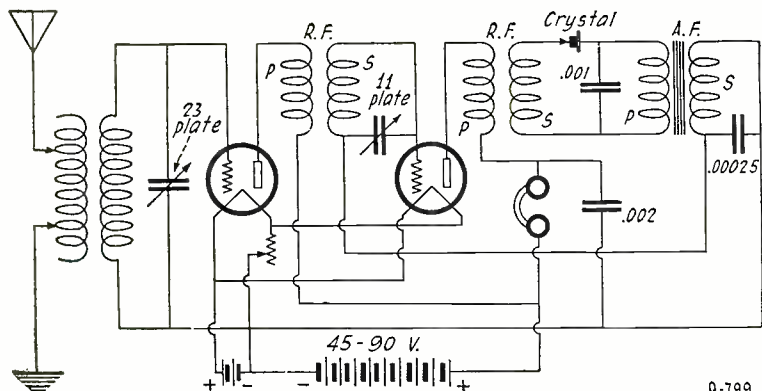

The Two Tube Erla Reflex Circuit Will Give Ample Volume with a Loud Speaker for All But the Most Distant Stations.

SECONDARY TUNING

(796) Mr. Graham Talley, Carthage, Mo., asks:

Q. 1. In making a three-circuit set, which will work the better, a secondary condenser or a grid variometer?

A. 1. A secondary condenser will give better results, as sharper tuning and a wider range of wave-lengths will be had. If a variometer is used that is large enough to reach the higher wave-lengths it will not be possible to tune down to 200 meters.

Q. 2. I have heard that if a Gold Grain detector is used in an Erla reflex circuit it will burn out the elements of the detector. Is this correct?

A. 2. There will be no danger of the detector being burned out in this or any other reflex circuit. The crystal is in series with the secondary of the R.F. transformer and the primary of the A.F. transformer only and there is no battery in this circuit.

"C" BATTERY IN R.C. SET

(797) Mr. Edwin J. A. Harper, Pittsburg, Pa., requests:

Q. 1. Please let me know how a "C" battery may be used in an R.C. set.

A. 1. The only way to use a "C" battery in an R.C. set would be to insert a battery of required size in the grid circuit of each amplifying tube. The negative terminal should go to the grid and the positive terminal through the secondary of the amplifying transformer to the negative of the "A" battery. Unless you are able to rearrange the wiring inside the set we would not advise that a "C" battery be used.

SHORT CIRCUITS

(798) Mr. O. Ingmar Oleson, Ambrose, N. D., wants to know:

Q. 1. What would happen if a head-set with bare connections on the outside of the receiver cases should touch the ground wire while operating a single circuit receiver?

A. 1. If this should happen the "B" battery would be shorted and the phones might possibly be burned out.

Q. 2. What would happen if the grid and plate connections should touch each other?

A. 2. In this case the tube might function as a two-element valve, but the signals would be very weak.

Q. 3. What would happen if the tickler should become grounded?

A. 3. The answer to question No. 1 also answers this.

ERLA REFLEX CIRCUITS

(799) Mr. J. O. White, New Rochelle, N. Y., writes:

Q. 1. Please publish the circuit of the Erla two-tube reflex receiver.

A. 1. This circuit appears in these columns.

Q. 2. Also give the circuit of the Erla Triplex receiver.

A. 2. This circuit is also given. No potentiometer is used in these circuits, thus allowing a full negative bias on the grids of the tubes. When used with Erla instruments, wonderful results are claimed for both circuits. Special reflex transformers are used which eliminate distortion and instability.

BODY CAPACITY

(800) Mr. Edward Howes, Oshkosh, Wis., writes:

Q. 1. I have a shield on the back of my set and it is properly grounded, however, if I take my hand away from my condenser dial it destroys my tuning. How can this be prevented?

A. 1. We note that you say your shield is on the back of your set. We presume you mean on the back of the panel where it belongs. If you are using a secondary condenser, the movable plates should be connected to the filament side of the secondary and not to the grid side. If this connection is correctly made, very little capacity effect should be noticed.

Q. 2. Does the UV-199 tube have anything to do with this?

A. 2. There should be no more capacity effect with this tube than with any other.

R.F. WITH THREE-CIRCUIT RECEIVER

(801) Mr. Thomas Gay, Alhambra, Cal., wants to know:

Q. 1. Can one stage of radio frequency and one stage of audio frequency amplification be

added to a three-circuit receiver? Please publish diagram.

A. 1. This diagram appears herewith. One stage of radio frequency is placed before the tuner. In this way regeneration may also be used. If there is a variable condenser in the antenna or ground circuit of the variocoupler it must be placed in shunt, as shown.

Q. 2. Is there any other way in which I can increase the receiving range of my set?

A. 2. This is the only way in which a greater receiving range may be had.

CHARGING STORAGE "B" BATTERIES

(802) Mr. Geo. Jackson, Chicago, Ill., asks:

Q. 1. Can a homecharger, manufactured by the Automatic Electrical Devices Co., be used to charge a storage "B" battery?

A. 1. We give herewith a diagram showing how a storage "B" battery may be charged by a homecharger. A six-volt storage "A" battery is connected to the charger in the usual manner. The regular connection to the lamp socket is also made. The fuse must be removed from the charger before the "B" battery is connected. The negative of the "B" battery is connected to the binding post that the negative "A" is connected to. The positive terminal of the "B" is connected to one side of the A.C. line with a 50- or 75-watt lamp in series. The other side of the A.C. line is connected directly to the vibrator screw, as shown on the diagram. If connections are properly made the lamp will burn quite dully.

ELECTROLYTIC RECTIFIER

(803) Mr. J. M. Conrow, Hampton, Ia., requests:

Q. 1. Will you please publish a wiring diagram for a home charger, consisting of four jars with lead and aluminum plates so that a six-volt storage battery can be charged?

A. 1. A diagram of this electrolytic rectifier was shown in answer to question 759 in the October issue of RADIO NEWS.

Q. 2. Will better results be obtained in a two-circuit regenerative receiver, with spider web or honeycomb coils?

A. 2. This circuit will work equally well with either set of coils.

Q. 3. What size coils should be used in this circuit?

A. 3. The size of the primary coil will depend upon the length of the antenna. A honeycomb coil of 50 or 75 turns with a variable condenser in series can be used in this position. The secondary coil should have at least 50 turns and the tickler should have 75 turns. The spider web coils should have about 10 turns more on each coil for the same wave-lengths.

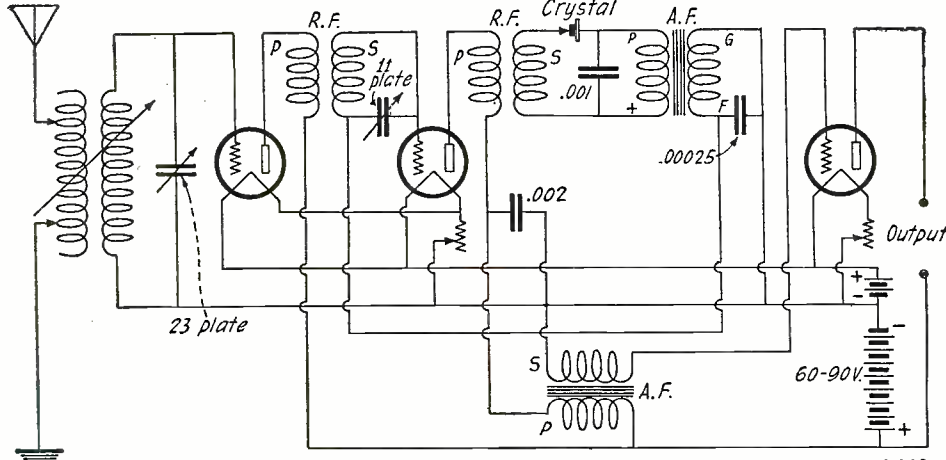

Remarkable Results Are Claimed for the Erla Triplex Circuit Shown Here When Erla Transformers and Fixed Crystal Detectors Are Used.

METAL CABINET

(804) Mr. Alvin Lewis, St. Paul, Minn., wants to know:

Q. 1. Would a cabinet made of sheet iron and grounded, effect the efficiency of a three-circuit set?

A. 1. A cabinet of this kind would have detrimental effect on a receiver, but if made of copper or brass, it would prove very effective in eliminating induction from outside sources and body capacity effects.

Q. 2. Is it possible to make a combination three-circuit and single-circuit receiver?

A. 2. It is not advisable to make a combination receiver of this kind, as the switching arrangement would be too complicated. We are showing a diagram, however, where, by means of two switches, a two-circuit regenerative receiver may be converted into a single circuit set.

MYERS TUBES

(805) Mr. Niles U. R. Johnson, Pensacola, Fla., asks:

Q. 1. Will Myers' tubes amplify and detect as well as standard six-volt tubes?

A. 1. These tubes will prove very good as amplifiers and detectors. They probably will not amplify at audio frequency as well as the UV-201A tube, but they will give excellent results when used for radio frequency.

Q. 2. Will Myers' tubes operate on filament control devices?

A. 2. We are undecided as to just what is meant by this question. An ordinary 10-ohm rheostat will be satisfactory to use with these tubes, however. With a 6-volt storage battery care should be taken not to burn the filaments too brightly as these tubes operate on four volts.

Q. 3. What can I use as a fixed inductance to avoid the use of a coupler?

A. 3. Spider web or honeycomb coils may be used in place of a variocoupler with excellent results.

A.F. AMPLIFICATION WITH CRYSTAL RECEIVER

(806) Mr. C. C. Gregson, Corwith, Ia., writes:

Q. 1. I have a crystal set that works remarkably well and would like to know if audio frequency amplification can be added.

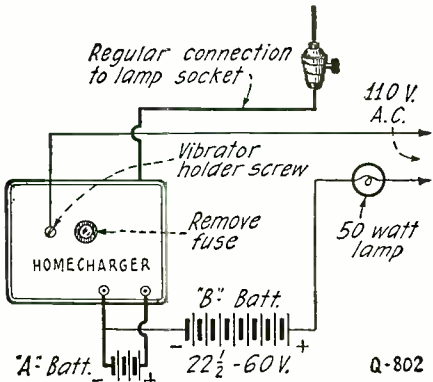

Q-802

If You Want to Charge Your Storage "B" Battery with a Homecharger, Follow This Diagram.

A. 1. Audio frequency amplification can be used with good results with a crystal set. The primary of the first A.F. transformer is connected in the circuit in place of the phones.

Q. 2. Please publish a two-stage amplifier to be used with a crystal set.

A. 2. This circuit appears in these columns.

Q. 3. Will two stages run a loud speaker?

A. 3. Sufficient volume on local stations will be obtained to operate a loud speaker with this circuit.

SELECTIVITY OF TUNED R.F.

(807) Mr. W. A. Pope, Cincinnati, Ohio, asks:

Q. 1. Would it be possible to tune out local interference from a large broadcasting station located about one mile away, with the tuned radio frequency set shown in your September issue?

A. 1. If this tuned radio frequency receiver is well constructed it will prove very selective,

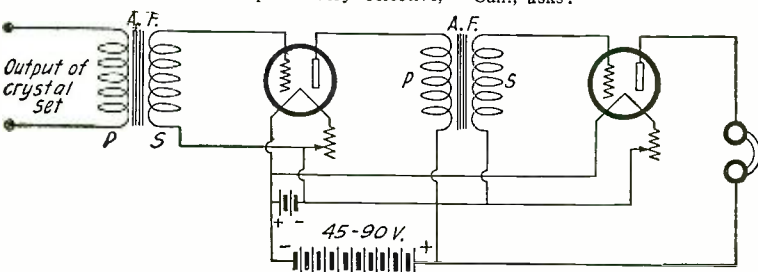

Q-806

Much Greater Volume Will Be Obtained from a Crystal Receiver by Using Two Stages of Audio Frequency Amplification.

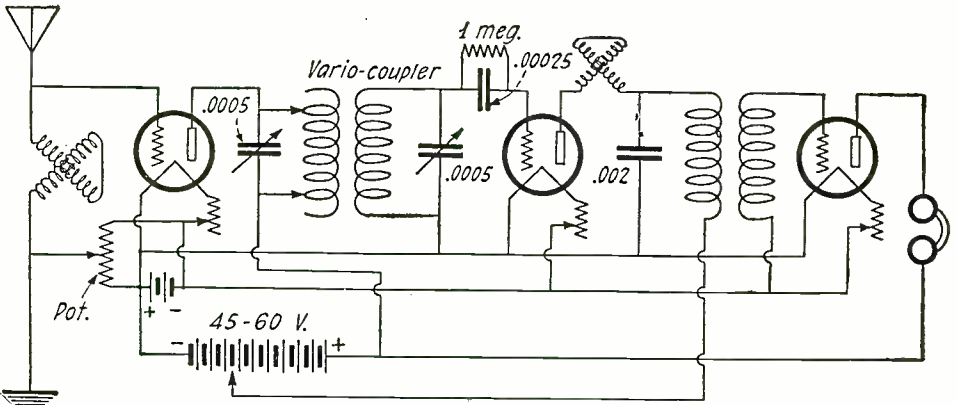

Q-801

Here is Shown the Best Method of Using One Stage of R.F. Amplification with a Standard Regenerative Receiver.

but we cannot say whether a powerful station only one mile away will cause interference or not.

WD-11 IN REFLEX

(808) Mr. N. H. McCoy, Waco, Texas, wants to know:

Q. 1. Will a WD-11 tube give good results for headphone reception in the Erla Duo-Reflex receiver?

A. 1. Good results will be had with this tube in this circuit. Not more than 60 volts should be used on the plate.

Q. 2. Would a variocoupler with a single set of taps be as effective as those with two sets of taps?

A. 2. This variocoupler will prove efficient, but a variable condenser should be placed in the antenna circuit for close tuning.

Q. 3. Would honeycomb coils be as efficient in this circuit as the variocoupler?

A. 3. If the proper size coils are used, they will be just as satisfactory as the coupler. Coils of 50 turns may be used for both primary and secondary.

SUPER-HETERODYNE

(809) Mr. M. L. Ainsworth, Mason City, Ill., asks:

Q. 1. Can I use common "A" and "B" batteries in the super-heterodyne set shown on page 24 of the July number of RADIO NEWS?

A. 1. A common "A" battery may be used, but we would advise separate "B" batteries in this particular circuit.

Q. 2. Would it be better to use UV-199 tubes for the radio frequency?

A. 2. UV-199 or C-299 tubes will give very good results when used as radio frequency amplifiers in this circuit, but UV-201A or C-301A would give greater amplification.

STATIC

(810) Mr. C. D. Wiser, Harmony, Pa., writes:

Q. 1. I have a regenerative set using a variocoupler and two variometers. I am troubled with a grinding noise on all wave-lengths, and sometimes a whistle. Can you tell me what the trouble is?

A. 1. Probably a good deal of this interference is caused by static. This can be determined by disconnecting the antenna and ground, and if this is the cause, the noises will disappear. Such noises may also be caused by a poorly constructed grid leak or by a defective "B" battery. Try a different detector tube. The whistle is evidently caused by too much regeneration.

Q. 2. In an audio frequency amplifier, is it better to use a transformer having a 3 to 1 ratio in the first step and one having a 10 to 1 or 6 to 1 ratio in the second step; or both transformers of the same ratio?

A. 2. If two transformers of different ratios are used, the one having the small ratio should be placed in the second step. Good results will be had if both transformers have a ratio of 3 to 1 and there will not be so much chance for distortion.

TRANSFORMERS FOR REFLEX

(811) Mr. Geo. Maynard, Saskatoon, Sask., Can., asks:

Q. 1. Can Erla radio frequency transformers, Type AB1-2-3 be used in the four-tube reflex circuit shown on page 24 of the July number of RADIO NEWS?

A. 1. These transformers may be used in this circuit, but we would suggest that the Erla transformer, made especially for reflex circuits, be used.

Q. 2. Can the first three tubes be controlled by one rheostat, and of what ohmic resistance?

A. 2. One rheostat may be used on the first three tubes. The resistance will depend upon the tubes and voltage used and the rheostat should be capable of handling the current drawn by the three tubes.

Q. 3. Would you suggest UV-199 or WD-12 tubes in this set?

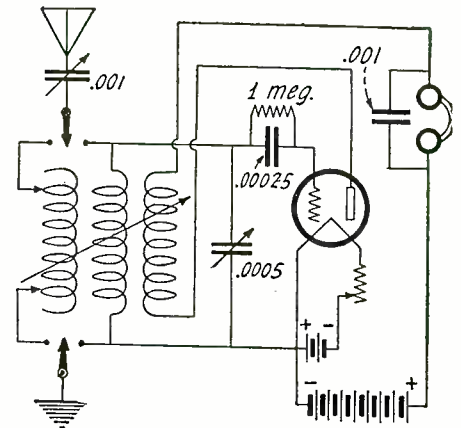

Q-804

When There is No Interference, a Single Circuit Receiver Might Give Louder Signals. A Two-Circuit Regenerative Set May Be Quickly Changed to a Single Circuit by Means of Switch as Shown.

A. 3. UV-199 or C-299 tubes would give best results in this circuit.

SIMPLE TRANSMITTER DATA

(812) Mr. Harold Rubman, N. Y. C., wants to know:

Q. 1. What tube should be used in the simple phone and C.W. transmitter shown in answer to question 749 in the September issue of RADIO NEWS?

A. 1. This depends upon the plate voltage to be used. A UV-201 or C-301 may be used with fair results in this set. If 250 or 350 volts are employed, a five-watt transmitting tube is recommended.

Q. 2. What size wire is used for the antenna coil?

A. 2. This coil should be wound with No. 14 or No. 16 wire.

Q. 3. Can "B" batteries be used efficiently and economically to supply the 250 volts needed?

A. 3. "B" batteries will give very good results with this set, but they will not prove very economical unless they are of the storage type.

REGENERATION WITH REFLEX

(813) Mr. Russell MacQuilkin, Cleveland, Ohio, inquires:

Q. 1. In reference to hook-up number 71 in the book entitled "100 Radio Hook-ups," I would like to know if it is possible to use two variometers and a variocoupler to produce regeneration.

A. 1. This is a three-tube reflex receiver using two stages of radio and audio frequency amplification. As a loop is used for an antenna, a variocoupler cannot be employed as a tuner. Also, regeneration cannot be had by means of a plate variometer when radio frequency is used in any circuit.



New Radio Patents

INDUCTANCE

(Patent 1,465,546. Issued to Harold P. Donle, of Meriden, Conn. August 21, 1923.)

Spiral windings one turn thick have been used and have many advantages, largely of a mechanical nature, but the disadvantage of high distributed capacity and difficult to construct. To overcome these difficulties, there is constructed a simple and inexpensive form of inductance, the preferred form of which comprises a disc of insulating material having peripheral slots with a single length of wire woven back and forth through these slots. These slots are preferably narrow compared to the distance between the slots and the wire in adjacent turns runs parallel over a large portion of each turn.

A single length of wire is wound back and forth through these slots beginning at the inner ends of

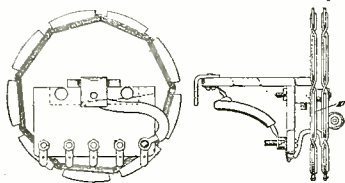

the slots and working outwardly so that adjacent lengths of wire in a given turn lie on opposite sides of the disc and the corresponding lengths of wire in the next layer lie on opposite sides of the disc, the lengths of adjacent layers crossing each other at more or less abrupt angles in the slots. By this construction we are able to secure a considerably lower distributed capacity than is possible with an ordinary flat spiral and without materially reducing its inductance or increasing its resistance. It is, therefore, possible to concentrate the inductance in a very thin and convenient form having a low distributed capacity, a low resistance and at the same time a considerable inductance.

Obviously, two of these coils may be wound on the same disc. By using two of these duplex semi-circular coils, one coil being free to rotate on its axis with relation to the other, it is possible to alter the total inductance of the circuit. By using three discs, each carrying two windings in series, a convenient form of variometer may be provided.

DEVICE FOR ELIMINATING BODY CAPACITY EFFECTS IN RADIO INSTRUMENTS

(Patent 1,464,708. Issued to Thomas M. Harrigan, of Woodstock, Vt. August 14, 1923.)

This invention relates to a device for eliminating body capacity effects in radio instruments, and has for its object to provide a device through the medium of which certain dials employed for ad-

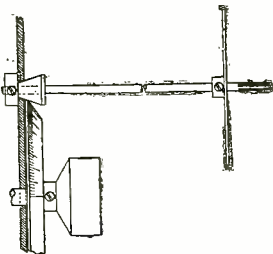

justing portions of a radio instrument, particularly the condenser, may be rotated while tuning the instrument without the body of the operator influencing the instrument and thereby rendering it difficult to properly tune the same.

Another object of the invention is to provide a device which may be employed in a manner to obtain a much more delicate adjustment of the dial and portion of the instrument associated therewith than is possible through the medium of the usual handle provided for the dial.

VACUUM-TUBE CIRCUITS AND METHOD OF OPERATING THEM

(Patent 1,426,755. Issued to Robert C. Mather, of New York, N. Y. August 22, 1922.)

It is well known in the art that a vacuum tube of the three electrode type, for example, will reproduce in amplified form in its output circuit impulses impressed upon its input terminals, and that the amplified impulses may be impressed on the input terminals of other tubes to give any desired degree of amplification. When such a mul-

tistage amplifier is employed to amplify low frequency impulses, it is generally preferable to have a direct coupling instead of an inductive coupling between stages in order that the low frequency impulses will be accurately reproduced by the

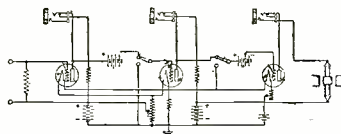

amplifiers. But when such a direct coupling is employed considerable difficulty is experienced when signals are being received from preventing the output current of one tube from so affecting the potential applied to the control electrode of a second tube that the second tube is either blocked or has its amplifying action destroyed on account of its control electrode becoming too positive or too negative. In accordance with this invention, it has been found that the operation of such a multistage amplifier is considerably improved by providing adjustable sources of potential for the control electrodes of the tubes, and by providing switching means between the stages whereby the output current of each tube may be given its proper value by adjusting the normal source of potential for its control electrode independently of this influence of the output current of the preceding tube.

RADIO RECEIVING SYSTEM

(Patent 1,464,533. Issued to Siegmund Loewe, of Berlin, Germany, August 14, 1923.)

It has been found in the operation of audion receivers which utilize vacuum tube amplifiers that there is apt to be present a local oscillation in one or more of the various circuits and that it is extremely difficult to avoid these oscillations.

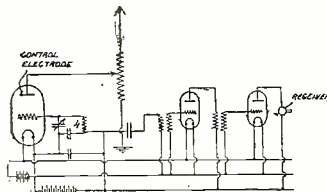

Even in multi-stage amplifiers which do not use an audion or a vacuum tube detector, the local oscillation could be prevented only by conductively connecting the primary and secondary of the amplifying transformer. Heretofore this procedure has not been adopted when audion detectors were employed, as such a connection would short circuit one of the audion batteries.

It is the object of this invention, therefore, to provide a circuit and connections whereby multi-stage amplifiers may be used in conjunction with vacuum tube detectors and the local oscillations may be eliminated by conductively connecting the primary and secondary windings of the first stage transformer.

VACUUM-TUBE APPARATUS

(Patent 1,463,432. Issued to Harold W. Nichols, of Maplewood, N. J., July 31, 1923.)

This invention relates to the production of the space current of a vacuum tube employed as an amplifier, a modulator, an oscillator, or for other purposes, by a source of alternating current.

It depends upon the functioning of the tube itself as a rectifier to reduce the alternating current to a pulsating direct current.

The invention comprehends also the connecting together of several tubes in such manner that they may be supplied with alternating current from the same source.

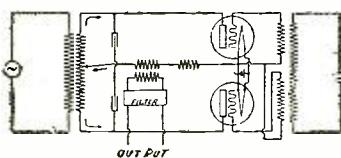

The invention comprehends also novel means of and methods for producing a continuous current of variable amplitude from a multi-phase or other suitable source of alternating current.

The invention comprehends also novel means of and methods for producing variably rectified current from an alternating source of voltage.

For signaling, the rectified current will be varied in accordance with low frequency waves such as telephonic voice currents.

The filaments of the vacuum tube or tubes may likewise be supplied with alternating current when tubes having filaments are employed.

RADIO RECEIVING APPARATUS

(Patent 1,455,141. Issued to Percival D. Lowell and Francis W. Dunmore, of Washington D. C. May 15, 1923.)

The object of the invention is to provide a receiver unit of maximum sensitivity employing thermionic vacuum tubes with their circuits supplied with energy from the standard alternating current residence lighting power.

Another object of the invention is to provide both radio and audio frequency amplification at

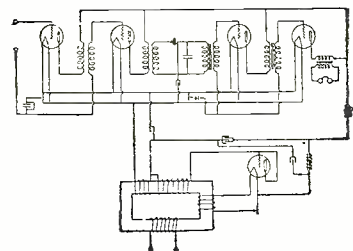

the receiver and means for energizing the power circuits of the amplifier stages from the standard alternating current residence lighting power without interference in the reproducing receivers from the hum of the alternating current power supply.

The receiver of the present invention is particularly adapted for general use in receiving radio broadcasting concerts, news, lectures, music and messages. The receiver does not require the usual primary or secondary batteries as a source of power for the filament and plate circuits of the vacuum tube amplifiers. A power transformer forms a part of the apparatus and power from the standard alternating current residence lighting circuit is supplied to the primary winding of the transformer. The transformer has a plurality of secondary windings wound in such ratio as to give proportionate current and voltage values as required by the filament and plate circuits of the amplifiers. A rectifier of the two electrode valve type is employed for obtaining a direct current for the plate supply to the tubes and the filament of this valve is also supplied with heating current obtained from one of the proportionate secondary windings of the transformer. The control of the filament temperature of this valve affords means for regulating the potential supplied to the plates of the tubes.

WIRELESS TRANSMISSION OF SPEECH

(Patent 1,341,232. Issued to Earl C. Hanson, of Washington, D. C., May 20, 1920.)

This invention relates to the transmission of

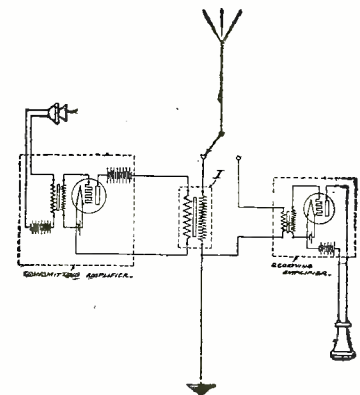

articulate speech through natural media, without connecting wires or other conducting members between the transmitting and receiving stations. It differs radically from the well known radio systems in that it employs only waves at audio, or voice-frequency, rather than waves of radio frequency. This distinction between audio or voice-frequency and radio frequency is now well

(Continued on page 744)

Correspondence from Readers

A WORD FROM 3VU

Editor, RADIO NEWS:

After reading the very interesting communication from Mr. S. L. Foster in the September issue of RADIO NEWS, I feel that I would like to say a few words about the much-talked-of "spirit of unfriendliness" existing between the amateur and the broadcast listener. Personally, I think that lack of co-operation between the two factions is not as bad as it is painted. However, there is admittedly some misunderstanding, which, with the proper spirit of fraternity, could easily be entirely cleared up.

The broadcast listener, consciously or otherwise, has killed the "goose that laid the golden egg" in the matter of technical or practical advice or assistance from the radio amateur. That is of course a general statement. As with all others matters, there are exceptions. By that I mean that there are amateurs as well as broadcast listeners who are so self-centered that they are unable to condescend to help anyone but themselves. Happily, such individuals are in the minority.

I have met a large number of newly "initiated" broadcast listeners who have assumed the attitude that when it comes to radio they "know it all." Apparently, manipulation of a single circuit receiver and the reading of a current radio magazine entitles them to the classification "Radio Engineer." This type of man generally comes to the amateur for assistance in building a set. In most cases he gets such advice as is required. When he builds his set he expects results right "off the bat." However, if results are not immediately forthcoming, and he doesn't get 1,500-mile reception the first night, the old law of self-preservation comes into play, and he discounts the advice and help of his amateur friend by blaming his failure to erroneous information. He forgets that the amateur in all probability experimented a great deal to get his set working at maximum efficiency. Also our broadcast listener friend forgets that he might possibly have made a constructional or wiring mistake, or have used a faulty unit, not discernible by superficial examination. Usually if he is conceited enough to blame his troubles on the man who helped him, he will go still further and "knock" him by telling others that Mr. Amateur is "dizzy" and doesn't know what he is talking about.

Still another angle: I know of several cases where amateurs have built good sets for their broadcast listener friends at the bare list cost of materials alone, their reward for the work being the promise of recommendation to the broadcast listeners' friends, to make sets for them at a fair profit. Later these promises were forgotten and the BCL's decided that as long as they could get good results with their sets, there wasn't much to them, and their experience and knowledge fitted them to build the sets themselves. Naturally that didn't make the aforementioned amateurs weep for joy. Such procedure is entirely unnecessary and only leads to further straining of amateur-BCL relations.

I agree very heartily with Mr. Foster in his complaints about thinly-veiled "new" circuit diagrams in some of the radio publications and in his grievance against the rough-shod policy of most radio dealers. His suggestion that radio dealers employ technical radio men to assist customers in the selection of equipment and render assistance in the assembly and use of same is very much worth-while.

J. H. SCHMIDT, 3VU,
1652 Park Road, N. W., Washington, D. C.

THE SINGLE CIRCUIT TUNER AGAIN

Editor, RADIO NEWS:

In your October issue of RADIO NEWS I read two letters that were not in favor of the single circuit, with reference to Mr. Brackenridge's letter in the July issue.

I am using the single circuit regenerative receiver with two steps of audio frequency amplification, with a large loop aerial in the attic. I am directly under a tin roof, with several tons of copper wires on the lower floor of the same building. I have received up to a thousand miles all summer, and have reached the Pacific Coast and Cuba in the winter months. I am only a BCL, but I am going to give Mr. Brackenridge a helping hand.

In the letter of Mr. Frederick L. Stafford of IBAG, Hartford, Conn., he asks why Paul Godley didn't take a single circuit to England and receive the American amateurs, and states that he is sure it would have been a failure. That may have been true if he had tried it, but here is an answer that will settle the DX reception of single circuit receivers.

ARE YOU

Informed regarding the latest electrical progress. You are a radio man, and as such, you should know all the latest inventions in electricity. PRACTICAL ELECTRICS prints hundreds of different kinks every month that will help your work along. One issue of this interesting magazine will convince you.

Interesting articles in December issue of PRACTICAL ELECTRICS:
Ultra-Sensitive Galvanometer, By Charles Mallinckrodt.
Ultra-Violet Rays in Photography, By Dr. Albert Neuberger, Berlin.
Electric Soldering and Welding Machine.
Coil Winder.
Simple High-Tension Experiments, By Harry R. Lubcke.
Electric Scales.
Trick Shuffleboard, By Walter B. Gibson.
Voyaging Beyond the Visible, By M. R. McCabe.
Army Loud Speaker.
Self-Polarizing Rectifier.
A. C. Motor and Bell.
Electric Drill.
Imitation Gassiot Cascade.
Electric Melting Pot.

If Mr. Stafford will get a copy of the January and February issues of RADIO NEWS, 1923, and turn to pages 1289 and 1473 respectively, he will read of Mr. Thomas Marshall's wonderful results in Hawaii with the famous single circuit. Mr. Marshall copied every district in the U. S. and some in Canada.

In this locality much interference is noticed from the high power arc stations. At no time do the broadcasting stations run together. I have yet to listen to a radio set that will eliminate arc mush.

Mr. Stafford also states that the best way to fix receiving set QRM is to junk the single circuit. In reply I want to say this: If the amateur operators who experience noises from nearby receiving sets would find them and instruct the owners in the proper tuning and operation, I am sure everyone concerned would be benefitted and this column would be minus a few unwarranted knocks.

Another good example of single circuit reception will be found in the May issue of RADIO NEWS, this year, page 1961.

In the reply to the letter of Mr. E. Peacox, Yonkers, New York, in the October issue. I would say that the Radio Corporation of America builds single circuit receivers and I have never found any of these lying outside of a window minus tubes.

It will be well for both Mr. Stafford and Mr. Peacox to read the articles refer-

red to above; I will gladly forward these to either upon request.

In conclusion I have a comeback for every knocker of the famous single circuit.

CARLTON J. LAKE,
Metuchen, N. J.

(What Mr. Lake states concerning Mr. Thomas Marshall's single circuit receiver is quite true. However, Mr. Marshall employs a Beverage "wave antenna" which cannot be classified with the general run of aerials used by amateurs and broadcast listeners. A wave antenna has strong directional characteristics and is a very efficient collective agency. What is more, it is designed to work on a definite band of wave-lengths and is practically immune from interfering waves of other frequencies. This is mentioned lest there be a general belief that Mr. Marshall's success with a single circuit receiver can be duplicated by using a common form of aerial.—Editor.)

RE BOOTLEG TUBES

Editor, RADIO NEWS:

Noting your article on the bootleg tube question.

Having had some experience in inventing and patenting a few things during my life, I realize that there is really not the protection in a patent under our present laws that there should be. The fact is, though, in the case of the genuine radio tube (which in some cases is no better than the others) the manufacturers encourage bootlegging by charging the exorbitant prices which they do.

Any one of the firms mentioned could put any detector or amplifier tube on the market, to retail at from \$1.50 to \$2.50 with a fair margin of profit to all concerned.

Where would your bootlegger come in?

Jos. W. JACKSON,
391 Lewis Ave.
Brooklyn, N. Y.

MORE ON THE SINGLE CIRCUIT TUNER

Editor, RADIO NEWS:

In your July issue Mr. W. W. Brackenridge made several very broad statements concerning the single circuit receiver, that I take exception to. Perhaps I can correct some of the erroneous statements as to the advantages and disadvantages of a single circuit receiver.

The reason Mr. Brackenridge finds a portion of some amateur's wave on 400 meters or better is due to the first harmonic of the frequency at 200 meters. He would find it for all amateurs if he were located in a comparatively near region and used the same single circuit receptor.

The reason three-fourths of the amateurs use the single circuit receiver is not for its sharpness of tuning, but for its ease of operation, its comparative ease in change of wave-length. Even its ease of operation made it of no use during the time that spark reception was in vogue, for that was more than offset by the interference due to its broad tuning. With the advent of continuous waves came the reception by the heterodyne or rather autodyne method. The single circuit receptor was used in the oscillating state and became, as do all oscillatory circuits, responsive to a very narrow band of wave-lengths. Its ease of operation has caused its consequent rise in popularity.

The reception of broadcasting must be accomplished without the presence of an oscillating circuit, otherwise distortion will occur. So while the single circuit is a remarkably good autodyne for reception of continuous wave signals it is of no use in its

(Continued on page 770)

Complete List of Broadcasting Stations

Corrected to September 25th

Call	Location	Wave-length in meters	Call	Location	Wave-length in meters	Call	Location	Wave-length in meters
CFAC	Calgary, Alta., Can.	430	KFEC	Portland, Ore.	360	KFJR	Stevensville, Mont.	258
CFCA	Toronto, Ont., Can.	400	KFEJ	Tacoma, Wash.	360	KFJU	Kearney, Neb.	234
CFCB	Vancouver, B. C., Can.	400	KFEL	Denver, Col.	360	KFJX	Cedar Falls, Iowa	229
CFCE	Halifax, N. S., Can.	440	KFEP	Denver, Col.	360	KFKA	Greeley, Col.	248
CFCF	Montreal, P. Q., Can.	400	KFEQ	Oak, Neb.	360	KFKH	Lakeside, Col.	236
CFCH	Iroquois Falls, Ont., Can.	400	KFER	Fort Dodge, Iowa	231	KFLE	Denver, Col.	268
CFCK	Edmonton, Alta., Can.	410	KFEV	Douglas, Wyo.	263	KFZ	Spokane, Wash.	283
CFCN	Calgary, Alta., Can.	275, 410	KFEY	Minneapolis, Minn.	275	KGB	Tacoma, Wash.	252
CFCX	London, Ont., Can.		KFEZ	Kellogg, Idaho	360	KGG	Portland, Ore.	360
CFPC	Fort Frances, Ont. Can.		KFFA	St. Louis, Mo.	360	KGJ	Portland, Ore.	360
CFTC	Toronto, Ont., Can.		KFFB	San Diego, Cal.	244	KGW	Honolulu, T. H.	360
CFYC	Vancouver, B. C., Can.		KFFC	Boise, Idaho	240	KGY	Portland, Ore.	492
CHBC	Calgary, Alta., Can.	410	KFFE	Pendleton, Ore.	360	KHJ	Lacey, Wash.	258
CHCA	Vancouver, B. C., Can.		KFFO	Hillsboro, Ore.	229	KHJ	Los Angeles, Cal.	395
CHCB	Toronto, Can.		KFFP	Moberly, Mo.	275	KHO	Seattle, Wash.	360
CHCF	Winnipeg, Man., Can.		KFFQ	Colorado Springs, Col.	360	KJQ	Stockton, Cal.	360
CHCS	London, Ont., Can.		KFFR	Sparks, Neb.	226	KJR	Seattle, Wash.	270
CHCX	Montreal, Que., Can.		KFFV	Lamoni, Iowa	360	KJS	Los Angeles, Cal.	360
CHYC	Montreal, Que., Can.	410	KFFX	Omaha, Neb.	278	KLN	Del Monte, Cal.	261
CHXC	Ottawa, Ont., Can.	450	KFFY	Alexandria, La.	360	KLS	Oakland, Cal.	360
CJBC	Montreal, Que., Can.	420	KFFZ	Dallas, Texas	360	KLX	Oakland, Cal.	360
CJCA	Edmonton, Alta., Can.	450	KFGC	Baton Rouge, La.	254	KLZ	Denver, Col.	360
CJCB	Nelson, C. C., Can.	400	KFGD	Chickasha, Okla.	248	KMJ	Fresno, Cal.	360
CJCD	Toronto, Can.	410	KFGH	Stanford University, Cal.	360	KMO	Tacoma, Wash.	360
CJCE	Vancouver, B. C., Can.	420	KFGJ	St. Louis, Mo.	226	KNJ	Roswell, N. M.	250
CJCH	Toronto, Ont., Can.		KFGL	Arlington, Ore.	234	KNT	Aberdeen, Wash.	263
CJCI	St. John, N. B., Can.	400	KFGP	Cheney, Kan.	229	KNV	Los Angeles, Cal.	360
CJCN	Toronto, Ont., Can.		KFGQ	Boone, Iowa	226	KNX	Los Angeles, Cal.	360
CJCS	Halifax, N. S., Can.		KFGV	Utica, Neb.	224	KOB	State College, N. M.	360
CJCS	Oids, Alta., Can.	400	KFGX	Orange, Texas	250	KOP	Detroit, Mich.	286
CJCY	Calgary, Alta., Can.		KFGY	Baudette, Minn.	224	KPO	San Francisco, Cal.	423
CJCG	London, Ont., Can.	430	KFGZ	Berrien Springs, Mich.	268	KQI	Berkeley, Cal.	360
CJNC	Winnipeg, Man., Can.	400	KFHA	Gunnison, Col.	360	KQM	San Jose, Cal.	360
CJSC	Toronto, Ont., Can.		KFHB	Hood River, Ore.	280	KQP	Hood River, Ore.	360
CKAC	Montreal, Que., Can.	430	KFHD	St. Joseph, Mo.	226	KQV	Pittsburgh, Pa.	360
CKCB	Winnipeg, Man., Can.		KFHF	Shreveport, La.	266	KQW	San Jose, Cal.	360
CKCE	Toronto, Ont., Can.		KFHH	Neah Bay, Wash.	283	KRE	Berkeley, Cal.	278
CKCK	Regina, Sask., Can.	420	KFHI	Wichita, Kan.	224	KSD	St. Louis, Mo.	546
CKCR	St. John, N. B., Can.	400				KSS	Long Beach, Cal.	229
CKKC	Toronto, Ont., Can.					KTW	Seattle, Wash.	360
CKOC	Hamilton, Ont., Can.	410				KUO	San Francisco, Cal.	360
CKQC	London, Ont., Can.	410				KUS	Los Angeles, Cal.	360
CKY	Winnipeg, Man., Can.	450				KUY	El Monte, Cal.	360
CKZC	Winnipeg, Man., Can.					KWG	Stockton, Cal.	360
DN4	Denver, Colo.	360				KWH	Los Angeles, Cal.	360
KDEX	Shreveport, La.	360				KXD	Modesto, Cal.	252
KDKA	E. Pittsburgh, Pa.	326				KYQ	Honolulu, Hawaii	360
KDOW	New York, S. S. America					KYW	Chicago, Ill.	536
KDPM	Cleveland, O.	270				KZM	Oakland, Cal.	360
KDPT	San Diego, Cal.	300				KZN	Salt Lake City, Utah	360
KDYL	Salt Lake City, Utah	360				KZV	Wenatchee, Wash.	360
KDYM	San Diego, Cal.	252				NAA	Radio, Va.	435
KDYQ	Portland, Ore.	360				OA	Ottawa, Ont., Can.	
KDYS	Great Falls, Mont.	360				PWX	Havana, Cuba	400
KDYV	Phoenix, Ariz.	360				WAAB	New Orleans, La.	268
KDYX	Honolulu, T. H., Hawaii	360				WAAC	New Orleans, La.	360
KDZB	Bakersfield, Cal.	240				WAAD	Cincinnati, Ohio	360
KDZE	Seattle, Wash.	455				WAAF	Chicago, Ill.	286
KDZF	Los Angeles, Cal.	278				WAAH	St. Paul, Minn.	360
KDZI	Wenatchee, Wash.	360				WAAK	Milwaukee, Wis.	280
KDZK	Reno, Nev.	380				WAAM	Newark, N. J.	263
KDZQ	Denver, Col.	360				WAAN	Columbia, Mo.	254
KDZR	Bellingham, Wash.	261				WAAP	Wichita, Kan.	360
KDZT	Seattle, Wash.	360				WAAW	Omaha, Neb.	278
KFAD	Phoenix, Ariz.	360				WAAZ	Emporia, Kan.	360
KFAE	Pullman, Wash.	360				WABB	Harrisburg, Pa.	266
KFAF	Denver, Col.	360				WABC	Anderson, Ind.	229
KFAJ	Boulder, Col.	360				WABD	Dayton, Ohio	283
KFAN	Moscow, Idaho	360				WABE	Washington, D. C.	283
KFAP	Butte, Mont.	360				WABF	Mt. Vernon, Ill.	234
KFAQ	San Jose, Cal.	360				WABH	Sandusky, Ohio	240
KFAR	Hollywood, Cal.	280				WABI	Bangor, Me.	240
KFAU	Boise, Idaho	270				WABJ	South Bend, Ind.	240
KFAV	Venice, Cal.	258				WABK	Worcester, Mass.	252
KFAW	Santa Ana, Cal.	360				WABL	Storrs, Conn.	283
KFAY	Medford, Ore.	360				WABM	Saginaw, Mich.	254
KFBB	Havre, Mont.	360				WABN	La Crosse, Wis.	234
KFBC	Phoenix, Ariz.	238				WABO	Rochester, N. Y.	252
KFBE	San Luis Obispo, Cal.	358				WAI	Dayton, Ohio	
KFBG	Tacoma, Wash.	360				WATJ	Marshall, Mo.	360
KFBH	Sacramento, Cal.	283				WATU	Yankton, S. D.	360
KFBL	Everett, Wash.	224				WBAA	W. Lafayette, Ind.	360
KFBS	Trinidad, Col.	360				WBAD	Minneapolis, Minn.	360
KFBU	Laramie, Wyo.	283				WBAF	Moorestown, N. J.	360
KFCB	Salem, Ore.	360				WBAH	Minneapolis, Minn.	360
KFCF	Walla Walla, Wash.	360				WBAN	Paterson, N. J.	244
KFCH	Billings, Mont.	360				WBAO	Decatur, Ill.	360
KFCJ	Colorado Springs, Col.	360				WBAP	Fort Worth, Texas	476
KFCL	Los Angeles, Cal.	360				WBAU	Hamilton, Ohio	258
KFCM	Richmond, Cal.	244				WBAY	Columbus, Ohio	390
KFCP	Ogden, Utah	360				WBAW	Marietta, Ohio	246
KFCV	Houston, Texas	360				WBAX	Wilkes-Barre, Pa.	360
KFCY	Le Mars, Iowa	360				WBAY	New York, N. Y.	492
KFCZ	Omaha, Neb.	258				WBBA	Newark, Ohio	240
KFDA	Baker, Ore.	360				WBBC	Sterling, Ill.	229
KFDB	San Francisco, Cal.	509				WBBD	Reading, Pa.	224
KFDC	Spokane, Wash.	285				WBL	Anthony, Kan.	261
KFDD	Boise, Idaho	252				WBS	Newark, N. J.	360
KFDD	Tucson, Ariz.	360				WBT	Charlotte, N. C.	360
KFDD	Corvallis, Ore.	360				WBU	Chicago, Ill.	286
KFDL	Denver, Col.	360				WBZ	Springfield, Mass.	337
KFDO	Bozeman, Mont.	360				WCAC	Fort Smith, Ark.	360
KFDQ	Des Moines, Iowa	278				WCAD	Canton, N. Y.	280
KFDR	York, Neb.	360				WCAE	Pittsburgh, Pa.	462
KFDS	San Francisco, Cal.	360				WCAF	Rodgers, Mich.	360
KFDU	Lincoln, Neb.	240				WCAJ	New Orleans, La.	268
KFDV	Fayetteville, Ark.	360					Columbus, Ohio	286
KFDX	Shreveport, La.	360					University Place, Neb.	360
KFDY	Brookings, S. D.	360						
KFDZ	Minneapolis, Minn.	360						

MR. RADIO BEGINNER

Do you know that there is a magazine especially edited for your benefit that gives you, in a non-technical language, a wealth of radio articles that are not over your head and that you will enjoy? That magazine is SCIENCE & INVENTION.

13 Pages of Radio Articles
40 Radio Articles

will be found in the December issue.

**List of Radio Articles Ap-
pearing in December Issue
of Science & Invention**

Wireless Energy for Trains and Autos of Tomorrow.

Full Details of the New Rogers Loop.
An All-Wave Reinartz Tuner—With Full Working Drawings and Details. By Kenneth Harkness.

New German Loud-Speaker.
How to Build a Very Efficient, Portable One-Tube Set. By Herbert E. Hayden.

The Radio Oracle.
A Radio Circuit Control Board and Desk.
Radio Broadcast Station Photos and Descriptions.

Look for the Gold Cover

KFHJ	Santa Barbara, Cal.	360
KFHL	Oskaloosa, Iowa	227
KFHP	Kearney, Neb.	246
KFHQ	Los Gatos, Cal.	242
KFHR	Seattle, Wash.	275
KFHS	Hutchinson, Kan.	229
KFHU	Mayville, N. D.	261
KFHY	Trinidad, Col.	242
KFI	Los Angeles, Cal.	469
KFIB	St. Louis, Mo.	244
KFID	Iola, Kan.	240
KFIF	Portland, Ore.	360
KFIK	Gladbrook, Iowa	234
KFIL	Louisburg, Kan.	234
KFIO	Spokane, Wash.	252
KFIQ	Yakima, Wash.	224
KFIU	Juneau, Alaska	226
KFIV	Pittsburg, Kan.	240
KEIX	Independence, Kan.	240
KFIV	Seattle, Wash.	236
KFIZ	Fond du Lac, Wis.	273
KFJA	Grand Island, Neb.	244
KFJB	Marshalltown, Iowa	248
KFJC	Seattle, Wash.	233
KFJD	Greeley, Col.	236
KFJE	Oklahoma City, Okla.	252
KFJH	Selma, Cal.	273
KFJI	Astoria, Ore.	252
KFJJ	Carrollton, Mo.	236
KFJK	Bristow, Okla.	233
KFJM	Grand Forks, N. D.	229
KFJQ	Grand Forks, N. D.	252

KFJR	Stevensville, Mont.	258
KFJU	Kearney, Neb.	234
KFJX	Cedar Falls, Iowa	229
KFKA	Greeley, Col.	248
KFKH	Lakeside, Col.	236
KFLE	Denver, Col.	268
KFZ	Spokane, Wash.	283
KGB	Tacoma, Wash.	252
KGG	Portland, Ore.	360
KGJ	Portland, Ore.	360
KGW	Honolulu, T. H.	360
KGY	Portland, Ore.	492
KHJ	Lacey, Wash.	258
KHJ	Los Angeles, Cal.	395
KHO	Seattle, Wash.	360
KJQ	Stockton, Cal.	360
KJR	Seattle, Wash.	270
KJS	Los Angeles, Cal.	360
KLN	Del Monte, Cal.	261
KLS	Oakland, Cal.	360
KLX	Oakland, Cal.	360
KLZ	Denver, Col.	360
KMJ	Fresno, Cal.	360
KMO	Tacoma, Wash.	360
KNJ	Roswell, N. M.	250
KNT	Aberdeen, Wash.	263
KNV	Los Angeles, Cal.	360
KNX	Los Angeles, Cal.	360
KOB	State College, N. M.	360
KOP	Detroit, Mich.	286
KPO	San Francisco, Cal.	423
KQI	Berkeley, Cal.	360
KQM	San Jose, Cal.	360
KQP	Hood River, Ore.	360
KQV	Pittsburgh, Pa.	360
KQW	San Jose, Cal.	360
KRE	Berkeley, Cal.	278
KSD	St. Louis, Mo.	546
KSS	Long Beach, Cal.	229
KTW	Seattle, Wash.	360
KUO	San Francisco, Cal.	360
KUS	Los Angeles, Cal.	360
KUY	El Monte, Cal.	360
KWG	Stockton, Cal.	

MURDOCK RADIO

New Prices on MURDOCK HEADPHONES

These new low prices make Murdock Headphones a more wonderful value than ever. Standard for over 19 years. Satisfactory service always. Get a pair from your dealer.

\$4.00
2000 OHM

\$4.50
3000 OHM



NEW Murdock Multiple Phone Plug Jack
(CORD TIP TYPE)

This new plug enables you to connect 4 pair of headphones at one time. A great convenience. Get one.

\$1

MURDOCK LOUDSPEAKER

No need to pay high prices when you can get a Murdock Loudspeaker for only \$5. Complete with phone unit, fibre horn, aluminum tone chamber and moulded base.

\$5 Not For Use On Crystal Sets.

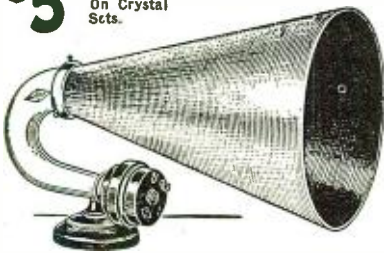

At All Dealers

WM. J. MURDOCK CO.
344 Washington Ave. Chelsea, Mass.
Sales Offices Chicago and San Francisco
STANDARD APPARATUS SINCE 1904

How To Misuse Radio Abbreviations Correctly

(Continued from page 700)

forget the QRA so that he will have something to say the next time he hears them.

If you're an old hand at the game—one of those who owned a decoherer back in 1776 (or was it 1492)—or else have invented a new cat-whisker or a self-starting binding post—then carefully ignore all QRA's as questions. If, though, you feel you must say something, then carefully and slowly send the name of the town you're in at not less than 40 words per minute to all beginners; and at not more than 10 words per to experienced men. NEVER repeat and if a repeat is asked for, burn out your tube so that you will have an excuse not to. This is very important and proves your experience.

QRB—What is your distance?
Ans.—I dunno.

No respectable beginner or short experience man would know the answer to this anyway; so no instruction is necessary.

Those of you who have had a few weeks of this health-destroying game should never forget to ask it when (QRB?) company is around because you will know the answer already and can impress every one with your ability to copy.

The experienced ham operator should have his distances firmly fixed in mind plus 20 per cent for lagniappe. This is important because the other fellow may also be given to hyperbole and prevarication.

QRC—What is your true bearing?
Ans.—Saturday night.

This is beyond the author. It is used only commercially and then always results in a holocaust of Hi's. It is neither ludicrous nor humorous, but passes for wit. Hams please forget.

QRD—Where are you bound for?

Ans.—(This is a family magazine so the answer is unprintable.)

More commercialism. Forget.

QRF—Where are you from?

Ans.—Guess.

This is used as a game on Sunday afternoon by the Commercials. Anyone guessing right is immediately sued for libel. Hams forget.

QRG—What line or radio control?

Ans.—Try and find out. Commercial. Don't bother.

QRH—What is your wave-length?

Ans.—Ur wv 200 mtrs om.

No ham misses the opportunity to obtain the excellent sending practice this affords. No ham plays the game according to Hoyle unless he puts at least five dots in his "Haitch." Ten or more qualifies him as having a little stranger in his home—a wig-wag key. It is a much desired honor.

The questioner never means what he says and should always be told his own wave as noted in the answer, above.

QRJ—?????????

Didn't know that this was present. Will look up in the official archives of the Kingdom of Megolomania of 2000 B. C. L.

QRK—How do I come in?

Ans.—You don't.

Used by all hams to refer to weak or unreadable signals such as unverifiable DX.

In commercial work signifies that the receiving op. will be forced to ask for a QTA. (See below.)

QRL—Are you receiving badly, shall I test?

Ans.—Yes!!!!

Having only one answer, don't wait for it but carefully test for at least 15 minutes.

USE A C H SHARP TUNER DIALS



Why the A.C.H. is different

3 in. DIAL

156-T0-1

4 in. DIAL

215-T0-1

Rough tuning with dial or one thousandth of an inch in either direction.

Price ACH 3" Dial complete.....\$2.50

Price ACH 4" Dial complete..... 5.00

Regular fitting 5/16" hole, 1/4" and 3/16". Bushings, 5c. each extra. 10c for all.

ASK YOURSELF THIS:

Would W. S. Brooker, Alberta, Canada write and say "held Ft. Worth, Texas one hour steady, thanks to the ACH" and order another if he was not satisfied? To retain your good will you must be satisfied or money refunded. Ask for circular No. 6 on RV Loud Talker and Detector set. A wonderful set. All ready for you to put together.

A. C. HAYDEN RADIO & RESEARCH CO.
Brockton, Mass., U. S. A.
Mail Orders Sent prepaid in U. S. A.

IF YOU CAN'T BUY THEM AT YOUR DEALER'S SEND DIRECT TO US

"Red-Heads" are guaranteed radio phones. You run no risk when you buy them. Money back if, after 7 days' trial, you're not satisfied that they're the best receivers on the market at the price. Why not act right now and get a pair? It'll mean getting the maximum from broadcasting from the day you put them into use.

RED-HEAD RADIO RECEIVERS



These remarkable head-sets are made by The Newman-Stern Co., one of the pioneer radio manufacturing houses in America.

JUST OUT

The new 1924 Model F

\$6.50 PER PAIR Complete

This is the standard 3,000 ohm "Red-Head." The 1924 Model F has eleven improved features. Sensitive and fine-toned; aluminum case; famous brown-red ear caps; military headband; high-grade cord.

The new 1924 "Red-Head" Jr.

\$5.00 PER PAIR Complete

The Junior Model has most of the quality features of the standard Model F here described. The resistance is 2,000 ohms per set instead of 3,000 ohms. A remarkable value.

"Red-Heads" sent prepaid on receipt of price if you are unable to get them at your dealer's.

THE NEWMAN-STERN COMPANY
Dept. RN Newman-Stern Bldg. Cleveland

England

Canada

AMPLION

Scotland

Australia

**Junior
DeLuxe**

Wales

New Zealand



\$26⁰⁰
List

Ireland

So. Africa

The Uncanny Amplion A "Human" Loudspeaker

Norway

India

You can scarce believe your ears when you first hear the Amplion Loudspeaker.

The clearness, softness and rich tone-quality with which it reproduces voice and music are so real as to be uncanny. You get a new thrill from radio. Delicious "chills" course up-and down your spine, as they do when you listen to some master of voice or instrument face-to-face.

Sweden

France

American Engineers who have tested the Amplion are unanimous in their opinion that for true reproduction and volume it is the best loudspeaker yet produced.

The Amplion is not a head receiver fitted with a horn, but the adaption for Radio of an electro-magnetic—and acoustic instrument which for thirty years has been successfully used in all parts of the world.

Denmark

Italy

Ask your dealer to let you hear the wonderful "AMPLION" Loudspeaker. Send for illustrated folder.

Patentees Alfred Graham & Company

SIGNAL ELECTRIC MFG. CO.

Sole United States Distributors

Menominee, Michigan

BURNDEPT OF CANADA, LTD.

Holland

Spain

Canadian Distributors

172 King St., West, Toronto

Belgium

Japan

*The Supremacy of the AMPLION
is the Supremacy
of Actual Performance*

For All Temporary Hook-ups

UNION RADIO TIP JACKS

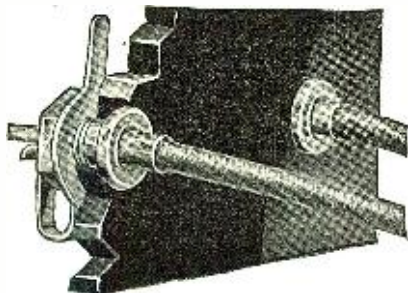

Cost Only 25c a Pair

They give you quick, positive connections for all hook-ups — when you are building your own set or are experimenting with new circuits.

They can be attached to all standard thicknesses of panels. The bushing is $\frac{1}{4}$ " in diameter and fits a $\frac{17}{64}$ " hole. Will grip all wires from 24 B & S gauge up to antenna wire, battery leads, loading coils and vacuum tube lugs.

No parts to chip, lose and deteriorate. All parts heavily nicked.

Other Guaranteed Parts

Dial adjusters for minute variations in capacities of variable condensers. Price 60c.

Variable Condensers. Famous for performance. Without dials, 3 Plate—\$1.00; 13 Plate—\$2.00; 23 Plate—\$2.30.

Tube sockets of molded condensite highly polished. Phosphor Bronze contact springs. Reinforced bayonet slot prevents breakage. Accommodates all standard tubes. Price 75c.

Should your favorite Radio Store not carry Union Radio Tip Jacks and Guaranteed Parts send your order direct to us, also write for your copy of "The Union Radio Catalog "C."

Retailers and Wholesalers

Samples of our guaranteed, reasonably priced "Quality Products" sent on request. Our terms and trade discounts are liberal. Write for our proposition.

UNION RADIO CORPORATION
200 MT. PLEASANT AVENUE, NEWARK, N. J.
NEW YORK OFFICE, 116 WEST 32nd STREET.

holding up all other traffic as long as possible—clears the air for a while. This is only for spark and particularly commercial work. C. W. is usually too sharp to get any satisfaction out of, unless you have a nice commutator ripple and 10 or 15 broadcast hams within the block. If such is the case, test until the riot call is sent in.

QRM—Are you interfered with?

Ans.—You're sending too fast.

Never used as a question. Those who can't copy are always qrm'd. This is an important abbreviation, so don't forget it. Besides, it sounds nice. See QRN.

QRN—Is static bad?

Ans.—Ya gotta bum fist!

Never used as a question. This is an excuse for not copying in ham parlance.

To the sea captain this means that the operator went to bed early the night before.

QRO—Shall I increase power?

Ans.—Sure, you bet, yep!

Used only in commercial work. It is the first thing to be said as soon as communication is effected and the answer is invariably as above. This is particularly true if a first class program is being rendered at nearby KDKA or etc.

Hams of the genuine brand are never able to increase power, for they are using all possible at the moment, always.

QRP—Obsolete.

QRQ—Shall I send faster?

Ans.—Sure, QRN, QTA.

Nuff sed.

QRS—Shall I send slower?

Ans.—No. QRM.

Should never be used as a question, as in that form it represents a deadly insult. When so used though it always receives the above answer.

QRT—Shall I stop sending?

Ans.—Shut up!!

Not used as a question at all. As an answer it seems to be a peculiar form of naval courtesy as it is always well thumbed (or footed) at naval coast stations.

QRU—Nothing here.

Obsolete. Always use "QTC nil." Gives more sending practice.

QRV—Are you ready?

Ans.—Yes, only need pencil, paper, and a receiver.

Nuff sed.

QRW—Are you busy?

Ans.—Yep.

Commercial. Hams forget.

QRX—Shall I stand by?

Ans.—Sure, stand by.

Always ask the other fellow to QRX when WAW wants a can of beans, when supper is ready, or it's Saturday night and time for the weekly cold.

QRY—When's my turn.

Ans.—It ain't.

Commercial. Hams don't bother.

QRZ—Are my sigs weak.

Ans.—Sure.

Obsolete.

QSA—Are my sigs loud?

Ans.—You bet! Damloud!

This is the first thing any ham should say to the next after raising him. No responsible ham would neglect this white lie. Admits only the answer as above and prepares the other fellow for the QTA next to be sent.

QSB—How do I sound?

Ans.—QRA!!

Nuff sed.

QSC—Is my spacing bad?

Ans.—No. (Prayer aside: Lord forgive us this day our daily sins as we let this bird off.)

Never used as a question. The answer is prepared for emergency, however.

QSD—Time please!

Ans.—It's — my time.

The time given should be accurate to within 15 minutes either way. Ex-tele-

FERBEND
TRADE MARK
Wave Trap
PATENT APPLIED FOR

The Original Wave Filter

Stops Interference!

Eliminates interfering stations. Improves the selectivity of the set. Eliminates local broadcasting. Selects between conflicting stations. Simplifies tuning. Often increases signal strength. Reduces howling and squealing.

The WAVE TRAP is mounted on a Formica panel in a beautiful mahogany finished cabinet 6x5x6, and is a high grade instrument throughout enhancing the appearance of the most expensive sets.

850
CHARGES
PREPAID

Ferbend Electric Co.
25 E. SOUTH WATER ST.
CHICAGO

**THE FRANSEN TUNER
AND VARIOCOUPLER**

**AT LAST THE PERFECT TUNER
for Broadcast Reception.**

The most efficient and selective tuner made. For single circuit with tickler or variocoupler with loose coupled primary and secondary circuits. Perfect and continuous variation of the inductance of the antenna circuit without SWITCHTAPS and without a VARIABLE CONDENSER in the antenna circuit. Complete for panel mounting, postpaid, \$7.50.

RADIO RESEARCH LABORATORIES
ATASCADERO, CALIFORNIA

NEON SIMPLEX RECEPTOR

\$9⁷⁵

WITHOUT
TUBE
Value \$20

**Vacuum Tube Receiver for Price of Crystal Set
NEW INVENTION REVOLUTIONIZES RADIO**

Range 1800 Miles. Can be used with a Loud Speaker, in connection with our 2 step amplifier. This set after a rigid test by the New York Tribune Institute was given the Certificate of Approval. One dial controls everything. Uses an ordinary dry cell battery. So simple can be worked by a child. Start receiving 10 minutes after arrival.

Neon set for . . . \$9.75 *Book of instructions*
Neon Phones . . . \$5.00 *with each set.*
Tube \$5.75 *Satisfaction Guaranteed*

SPECIAL OFFER Send \$17.75 and we will send you complete outfit, including phones and tube.

We Carry Complete Line of Standard Radio Parts.
Catalogue on Request.

ROYAL MFG. CO., Dept. 26 World Bldg., New York

The "A" Battery's Power in Your Radio Receiving Set

THIS IS NUMBER TWO OF A SERIES

THE sole purpose of the "A" Battery in your Radio Receiving Set is to furnish current to heat the filaments of the tubes.

And this can be done satisfactorily only by an "A" Battery that supplies an adequate steady current.

Anticipating the popularity of the dry cell tube in Radio, and realizing that it required a Dry Cell capable of standing up under service conditions differing from what dry cells are called upon to meet in other fields, the National Carbon Company developed the Eveready Radio Dry Cell specifically for this new use.

A dry cell gives its maximum service only when designed especially for the work it is intended to perform. There are for dry cells several uses which are so alike that one type of cell serves for all. This is the field covered by the ignition or general purpose dry cell.

The conditions encountered in Radio are different from the conditions grouped together under the term "general purpose." And while the general purpose dry cell performs well as an "A" Battery, it was found possible to produce a Dry Cell "A" Battery capable of delivering more service on Radio loads.

Thirty years of dry cell experience and an immense research organization resulted in the superior Eveready Radio Dry Cell. One of the outstanding features of this special cell is that while it will last much longer when used as an "A" Battery, it is no larger than the standard dry cell.

The increased service life of the Eveready Dry Cell "A" Battery greatly offsets the slight increase in cost; so this battery is not only the best, but it is the most economical you can buy. "The Story of Eveready Dry Cell Radio 'A' Batteries," which tells how to use Dry Cells to the greatest advantage with the various dry cell tubes now available, will be sent to you free on request.

* * * *

The "A" Battery gives power to your Radio Receiving Set. Eveready Batteries—especially made for Radio—serve better, last longer, give better results.

Note: This is number 2 of a series of informative advertisements which will appear in this magazine. They are designed to help users get the most out of their Batteries and their Radio Sets. If you have any battery problem, write to G. C. Furness, Manager Radio Division, National Carbon Company, Inc., 122 Thompson Ave., Long Island City, N. Y.

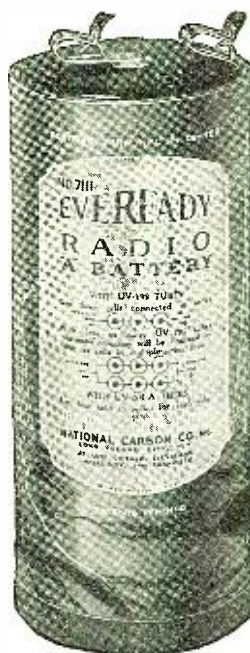

POWER for Your Radio Set

Eveready Dry Cell
Radio "A" Battery
(No. 7111)

Directions and wiring diagrams on the jacket tell just how to use this battery with the different dry cell tubes.

This special Radio Cell is also available in two and four cell multiple batteries for receiving sets employing from two to four WD-11 or WD-12 tubes.

Other Radio Batteries

Eveready Storage "A" Batteries—best suited for filament heating of all Radio Tubes not especially designed for dry cells. The quality storage battery with the long life plates, \$15 to \$20.

Eveready "B" Batteries—the life of your Radio.

Eveready "Three" Battery—3 cells, 3 purposes.

Manufactured and guaranteed by

NATIONAL CARBON COMPANY, Inc.

EVEREADY
Radio Batteries
—they last longer

Reliable
RADIO
Goods

Distributors for
Radio Corporation
of America

Grebe	Western Coil
Atwater Kent	Magnavox
Brandes	Burgess
Murdock	Gould
Nath. Baldwin	Eveready
Western Electric	Frost
Acme	Carter
All American	Dubilier
Signal	Howard
Chelsea	Eby
Cutler-Hammer	Bradley
	Jewell

and other standard manufacturers.

We carry a comprehensive stock of the latest receiving sets, parts and supplies of the leading manufacturers, and ship from stock promptly.

SEND FOR THESE

- Rubber Ear Muffs—Fit any American make of phones. Made by B. F. Goodrich Co. pair \$0.80
- Univernier—A geared dial for close tuning. Mention size of condenser or variometer shaft. Complete with dial 1.25
- Cutler-Hammer "A" Battery Switch—Push and pull switch requiring only one hole in panel, easily installed. ... 0.60
- Cutler-Hammer 25-Ohm Resistance—A variable resistance which can be attached to any rheostat or battery for use with low current tubes, pr. 0.25
- Barkeley-Lightning Arrester Switch—A combination of ground switch and lightning arrester pr. 3.50
- Magnavox M-1—Requires no battery. Best Loud Speaker for permanent magnet type 35.00
- Murdock Loud Speaker—A very efficient loud speaker particularly suitable for dry battery sets as it requires no battery current. 5.00
- UV-199 or C-299—These tubes require 3 volts and only .06 ampere filament current. Used in all the latest R.C.A. receivers. Can be used with adapter in place of any other standard tubes 6.50
- Frost Adapter for UV-199 Tubes—Tube fits in adapter, adapter in standard socket 0.50
- Phones—Murdock, Brandes, Frost, Nath. Baldwin and Western Electric Phones at standard prices.

FREE Illustrated,
CATALOG sent on
request.

Dealers

Buy reliable equipment from a house of established reputation. Send for catalog of tested and approved apparatus and our direct discount sheet.

JULIUS ANDRAE & SONS Co.
117 Michigan St., Milwaukee, Wis.

ANDRAE In Business Since 1860

phone centrals should always say "Just a minute please," and then give the time 10 minutes later 20 minutes earlier. Any receiving op. who gets the same time from two stations should consider himself stymied.

QSF—Transmission in series or alternate order?????
See QRJ.

QSG—Transmission in series of five.
See do.

QSH—Transmission in series of ten.
See do.

QSI—How much!
Ans.—Too much, it's—
Commercial. Don't bother.
QSK—Shall I cancel?
Ans.—QTA.
Nuff sed.

QSL—Please send card? I will send card.

Always use the above. Sounds friendly. Also, never send the card and don't expect one.

QSM—True course please?
Ans.—Waddyuh think I am, a compass? This has no relation to golf. Commercial. Hams forget.

QSO—Can you get —?
Ans.—Sure ga.

Should not be used as a question as a matter of courtesy. Never imply that any ham can't raise any other within 10,000 miles.

QSQ—Shall I tell that bird you're calling him?
Ans.—Yep.

QSP—Is so-and-so calling me?
Ans.—So-and-so is calling you. Hams forget. Commercial only.

QSR—I gotta message, or I want more. Used as much as possible. Good sending practice and every one else knows it doesn't mean anything, too.

QST—Well known contemporary. As a radio signal is a preliminary to almost anything. Tune out.

QSU—See you later. Not used by hams. Use CUL and then forget all about it.

QSV—See QRJ.

QSW—Increase spark frequency. Obsolete.

QSX—Decrease do. Do.

QSY—Shall I change wave?
Ans.—Sure.

This signal always starts a game of hide and seek with both hiding and neither seeking unless it is CQ about five minutes later. If either should find the other, then neither should know about it or else there will be two involuntary heart failures instead of one. Very amusing game and neither ham should speak to the other for a period of 24 hours, as both have guilty consciences.

QSZ—Send each word twice. Superfluous signal, for it's a habit anyway. Any ham caught using this should have his license reniged.

QTA—Repeat. Refers to last word, last three words, last message, or last half hour's work. Use the Ouija to find out which, for it isn't fair to tell.

QTC—Whatcha got?
Ans.—QTC nil.

After asking this question and getting the correct answer always say QTA in return. It sounds business like and shows you know the Q's like a brother.

9AKO

The call 9AKO has been issued to A. H. Barnett of 33 Kiwanis Apt., Fort Wayne, Indiana. 50 watts C.W. Strike out particulars of call 9AKV.

BUY DIRECT

Why Pay Dealers and Jobbers Large Profits?

- WD11—WD12—UV199 and UV201A Radiotrons \$ 5.43
- C11—C12—C299 and C201A Cunningham's 5.43
- "Trista" 3000 Ohm Guaranteed Head Sets 3.44
- True-Tone Supersensitive 3000 Ohm Head Sets 4.28
- Federal Telephone Radio Head Sets 5.59
- Original Nathaniel Baldwin Head Sets 9.58
- Original Nathaniel Baldwin Single Units 4.79
- Atlas Ampitone Loud Speaker Complete 19.95
- Rico Loud Speaker with Tune Phone unit 8.40
- Trista Loud Speaker (Its standard head sets) 1.98
- Standard 22½ V. "B" Battery small size 1.67
- Standard 22½ V. "B" Battery large size 2.88
- Standard 45 V. "B" Battery 9.95
- Trista 60 Ampere Hour Radio Storage Battery 14.95
- Trista 100 Ampere Hour Radio Storage Battery 12.79
- Sterling 10 Ampere Battery Charger 14.79
- Radio Home Charger De-Luxe 1.98
- Trista Audio or Radio Transformers 3.82
- All American Audio or Radio Transformers 3.98
- Acme Audio or Radio Transformers 3.98
- Eria Duo Reflex Radio Transformers Nos. 1 & 2 1.28
- 11 plate Variable Condenser 1.44
- 23 plate Variable Condenser 1.59
- 43 plate Variable Condenser with Vernier 2.88
- 43 plate Variable Condenser with Vernier 3.44
- Moulded Bakelite Silk Wound Variometer 3.98
- Moulded Bakelite Silk Wound Variocoupler 4.79
- Trista 180° Silk Wound Variometers 1.19
- Trista 180° Silk Wound Variocouplers 1.19
- Lic. DeForest Triple Coil Honeycomb Mountings 3.98
- Lic. DeForest Double Coil Honeycomb Mountings 2.79
- Lic. DeForest Single Coil Honeycomb Mountings39
- Trista Neutrodyne Transformers. Each98
- Bremer-Tully Air Cove Neutrodyne Transformers 1.49
- Bremer-Tully Mounted Neutrodyne Transformers78
- Bremer-Tully Universal Vernier Tuner 3.98
- Reinartz Green Silk Wound Tapped Coils 1.78
- Approved Porcelain Outdoor Lightning Arrester 1.19
- Trista 6 Ohm Fada Type Rheostat39
- Trista 30 Ohm Fada Type Rheostat48
- Trista 200 and 400 Ohm Fada Type Rheostat71
- Trista 30 Ohm Vernier Rheostats89
- Trista Standard or U.V.199 Bakelite Sockets39
- Federal Standard or U.V.199 Sockets79
- Trista Open Circuit Telephone Jack27
- Trista Double Circuit Telephone Jack52
- Trista Single Circuit Filament Control Jack35
- Trista Double Circuit Filament Control Jack39
- Trista Standard Phone Tip Plug82
- Carter Two-way Phone Tip Plug19
- Trista Switch Levers Adjustable Fada Type03
- Trista Phone Tip Binding Posts04
- Trista Rubber Tip Binding Posts04
- Trista Switch Contact Points or Stops09
- Trista 3 Inch Composition Dials23
- Dayton 3 Inch Bakelite Dials39
- Copper Aerial Wire (per 100 ft.)48
- Phone & Grid Condensers all cap08
- Nickle Plated Pocket Voltmeters 0 to 50 volt. 1.12

ALL MERCHANDISE GUARANTEED AS ADVERTISED OR MONEY REFUNDED. INCLUDE POSTAGE. NO C.O.D. SHIPMENTS WITHOUT DEPOSIT.

TRI STATE RADIO SALES COMPANY
214 VICTORIA BLDG. ST. LOUIS, MO.

Marvel - Capacity - Switch

Receives long waves in the parallel position; short waves in the series position; and waves of medium length by eliminating the condenser entirely.

THREE-WAYS

Series, Parallel, Direct-Ground

Patents Pending

Instructions for mounting and for wire connections given with each instrument.

Dial-mounted

Strictly of Anti-Capacity Type.

List Price \$1.25

Attractive discounts for dealers and jobbers.

MARVEL-SWITCH CO.
28 WEST 25th STREET NEW YORK

PATENTS

DON'T LOSE YOUR RIGHTS

Before disclosing your invention to anyone send for blank form "EVIDENCE OF CONCEPTION" to be signed and witnessed. Form and information concerning patents free.

LANCASTER & ALLWINE
270 Duray Bldg., Washington, D. C.
Originators of the form "Evidence of Conception"

Print Your Own

Cards, circulars, labels, book, paper, Press \$12. Larger \$35 Job press \$150. Save money Print for others, big profit. All easy, rules sent. Write factory for press catalog, TYPE, cards, etc. THE PRESS CO., D-72 Morriston, Conn.

SEE OUR GUARANTEE HOOK-UPS and CATALOG FREE

REDUCED PRICES

SERVICE AND QUALITY BUILT THIS HOUSE

ON STANDARD QUALITY PARTS

WE PAY TRANSPORTATION CHARGES IN THE UNITED STATES ONLY

PHONES THAT HAVE STOOD THE TEST. C161 Frost double set 2000 ohm \$3.65. C171 Frost double set 3000 ohm \$4.20. C162 Frost double set 2000 ohm \$4.20. C163 Frost double set 3000 ohm \$4.85. C172 Frost double set 2000 ohm \$5.39. C166 Brandea Superior double set \$5.45. C167 Brandea Navy type double set \$6.95. C168 Genuine Type C Baldwin Phones double set \$10.50. C169 Genuine Type C Baldwin Unit with cord \$5.35. BALDWIN LOUD SPEAKER \$25.00.

SPAGHETTI AND WIRE. C33 Per 4-ft. length .27c. C32 Tinned Copper No. 16 Wire . Ft. 2c. C34 Wire with insulation similar to spaghetti on it. Wire is tinned for soldering. Price 10 feet .37c.

ERLA R. F. TRANSFORMER. Specify 1st, 2nd or 3rd stage. C1500 Erla Transformer \$3.67.

ERLA REFLEX TRANSFORMER. C1650 Reflex Transformer \$4.67.

TESTED CRYSTALS. C12 Galena, per pkg. \$0.10. C13 Silicon, per pkg. .10.

JACKS AND PLUGS. Jacks are polished nickel, nickel-silver springs, pure silver contacts. Nickel washers for mounting on any panel 1/2 to 3/8 inch thick. Spread terminals make soldering easy. C133 One spring (open circuit) \$0.37. C134 Two spring (closed circuit) .45. C131 Four spring (two closed circuits) .54. C135 Three spring (two open circuits, called "single filament control") .58. C136 Five spring (two open and two closed circuits, commonly called "two circuit filament control") .75. C139 Plug with threaded barrel instead of set screw. Takes cord tbs. .45.

VARIABLE GRID LEAK. Percol mark type. Removable black enameled cap. C52 Grid Leak \$1.8c.

GRID AND PHONE CONDENSERS. Mounting holes spaced to fit screws of above Grid Leak. Mica insulation, wrapped with varnished cambric tape. Capacity, .0025 Mfd. C15 Grid Condenser .7c. C59 Phone Condenser .001 Mfd. .20c.

C. R. L. ADJUSTABLE GRID LEAK AND CONDENSER. A turn of the polished black knob will enable you to get the one and only one potential that provides the maximum signal strength. Made for panel mounting. C107 C. R. L. Adjustable Grid Leak and Grid Condenser \$1.49.

FRESHMAN MICON TESTED MICA CONDENSERS. C62 .0025 mfd. Condenser \$0.29. C63 .0005 mfd. Condenser \$0.29. C64 .001 mfd. Condenser .33. C65 .002 mfd. Condenser .33. C66 .0025 mfd. Condenser .44. C67 .005 mfd. Condenser .69. C68 .006 mfd. Condenser .69. C69 .01 mfd. Condenser 1.41.

FRESHMAN VARIABLE GRID LEAK AND GRID CONDENSER. For unbroken range—zero to 5 megohms, clarifies signals, lowers filament current, increases battery life, eliminates hissing. C60 Freshman Variable Grid Leak and Condenser \$0.92.

AERIAL WIRE. C355 Copper 7 strand 100 ft. coil \$0.77. C356 Shackle No. 14 Bare Solid Copper Wire 100 ft. Coils .55.

SWITCH POINTS AND STOPS. Brass, polished nickel finish. Screw size, 6/32x3/8 ins. long, two nuts with each contact point and one with stops. C158 Switch point 1/2" dia., 3/4" high. Each 3c. Dozen 18c. Hundred \$1.05. C130 Switch Point. Hurd diam., 1/4 inch; height, Each Doz. dred \$1.40. C150 Switch Stops. 3c 20c 1.40.

OUR GUARANTEE YOUR PROTECTION. Your satisfaction guaranteed. If for any reason you do not feel satisfied with your purchase, you may return it and we will refund your money. We will pay return transportation charges.

180° VARIOCOUPLER. The primary and secondary windings of this coupler are properly spaced. The center of the secondary is always in the center of the primary field. Black base, brown formica tube and nicked parts. Panel or table mounting. C1100 Coupler \$2.75.

180° MOULDED ROTOR TYPE COUPLER. This 180° variocoupler has heavy black tube and moulded rotor wound with green silk wire, and has 10 taps on the primary. Metal parts are brass nickel. Can be mounted on panel or table. C1120 Variocoupler \$3.75.

VARIABLE CONDENSERS. Condensers are made of heavy aluminum plates, evenly spaced with high grade bakelite ends. C1443 43 plates .001 Mfd. without dial \$1.73. C1423 21 plates .0005 Mfd. without dial 1.43. C1411 11 plates .00025 Mfd. without dial 1.32. C1403 3 plates .00005 Mfd. without dial .98.

VERNIER VARIABLE CONDENSERS. For fine tuning, neat appearance, this condenser is just the thing. Made of heavy aluminum plates and high grade bakelite ends. These condensers are furnished with neat appearing knob and dial. C1444—41 plates vernier .001 Mfd. without dial \$3.25. C1422—32 plates vernier .0005 Mfd. with dial 2.95.

ERLA AUDIO FREQ. TRANSFORMER. C1750 Erla Audio Transformer \$4.67.

INDUCTANCE COIL MOUNTINGS. For base or panel mounting. Connecting leads furnished, coil settings are adjustable by means of knobs. Made entirely of bakelite with nicked brass metal parts. Coil position can be locked by knurled set screws. C1603 Three coil mounting \$3.90. C1602 Two coil mounting 2.75. C1601 Single coil mounting .45.

INDUCTANCE COILS. Rigidly wound, nicely finished, low distributed capacity. All coils are equipped with standard mountings. We can supply any of these coils with or without mounting plugs. The wave lengths shown are range limits, based on variable condenser .001 mfd. capacity. Price un-Price mounted.

Table with columns: No., No. of turns, Wave Lengths, Price un-mounted, Price mounted. Rows include 1725, 1726, 1727, 1728, 1729, 1730, 1731, 1732, 1733, 1734, 1735, 1736, 1737, 1738, 1739, 1740.

INSULATORS. These are very strong strain type insulators. Each Doz. C360 Moulded insulator shown \$0.10 \$1.10. C365 Porcelain Insulators .09 .95.

VARIOMETERS. For efficiency, perfect inductive ratio, low capacity effect and neatness of design these variometers are unexcelled. Metal parts nicked. Stator and hall mahogany finish. Completely assembled. C1200 Variometer \$2.65. The above variometers knocked-down stator wires cemented in the stators. Rotors are wound. All metal parts included. C1205 Knocked-down Variometers \$1.85. C1220 Moulded Variometer \$4.35.

MOULDED VARIOMETERS. DIALS. Genuine Bakelite. Dial as pictured. Sharply engraved divisions and figures filled with a brilliant white. Set screws included. C502 Dial, 2 inch, 3-16 in. shaft \$0.39. C500 Dial, 3 inch, 3-16 in. shaft .48. C501 Dial, 3 inch, 1/4 in. shaft .48. C504 Dial, 4 inch, 1/4 in. shaft .75. Moulded composition dial as pictured. Has a luster that cannot be told from Bakelite. Set screws included. Each Doz. C563 Dial, 2 inch, 3-16 in. shaft .18 \$2.05. C550 Dial, 3-16 in. shaft .25 \$2.75. C555 Dial, 1/4 in. shaft .25 \$2.75. C565 Dial, 3/8 in. 1/4 in. shaft .35 \$4.00.

AUDIO FREQUENCY AMPLIFYING TRANSFORMERS. Correctly designed for minimum distributed capacity and low core loss. Shielded beautifully finished in nickel and black enamel. Ratio 5 1/2 to 1. C1506 Shielded Transformer \$3.75.

THORADARSON AUDIO FREQUENCY AMPLIFYING TRANSFORMERS. There is probably no better known transformer. Made by a company that specializes in transformers. Entirely encased in sheet aluminum shield. Heavy connecting straps to binding posts. C1504—Thoradarsen Transformer, 3 1/2 to 1 \$3.40. C1505 Thoradarsen Transformer 6 to 1 3.80.

"B" BATTERIES. Standard high grade radio "B" batteries. Never over five days old. C230 2 1/2 volt Signal Corps type. Size 3 3/8 x 2 1/4 inches \$1.18. C235 2 1/2 volt U. S. Navy variable—5 positive tabs. Size 4 1/2 x 2 1/2 inches \$1.98. C240 2 1/2 volt large variable—5 positive tabs. Size 6 1/2 x 4 1/2 \$2.25. C245 45 volt large size binding posts. Size 7 1/2 x 6 1/2 x 3 \$4.50.

INDUCTANCE SWITCH. For neat appearance and time saving, we suggest this inductance switch, as it needs but one hole in the panel to be mounted. Switch Points are mounted on this switch, 15 switch points, in all. C1095 Inductance Switch \$1.29.

MAGNET WIRE. Quality magnet wire. We carry three types in stock. Each spool is 8 oz. Double cotton covered. Green silk. Enameled. Size Price Size Price Size Price. C18 \$0.40 C20 \$0.78 C20 \$0.39. C20 .55 C22 .90 C22 .50. C22 .70 C24 1.05 C24 .55. C24 .80 C26 1.18 C26 .60. C26 .90 C30 1.70 C30 .65. C28 1.05 C32 2.00 C32 .70. C30 1.45 C36 2.70 C36 .90.

SWITCH LEVERS. A high grade, polished nickel-plated lever with solid moulded black composition knob. Complete with panel bushing. C151 1 in. Radius 18c \$2.10. C155 1 1/2 in. Radius 18c 2.10.

VACUUM TUBES. Genuine Cunningham or Radiotron made by the General Electric Co. Every tube guaranteed new and in original package. We do not sell "bootleg" tubes. Will ship brand in stock unless specified. C300 UV200 Detector \$4.40. C301A UV201A Amplifying \$5.90. C11, WD11 1 1/2 volt .590. C12, WD12 1 1/2 volt .590. C299, UV199 3 volt .590.

QUALITY SOCKETS. For C200, C301A, C12 or WD12 tubes. Signal socket. Tube made of brass, nickel-ened. Base is bakelite. Panel or base mount. Belden socket. Made of bakelite. Panel or base mount. Great Lakes nickel socket. Panel or base mount. Great Lakes bakelite socket. Base mount only. All sockets have heavy spring contacts. C1073 Signal Socket \$0.65. C1074 Belden Socket .60. C1075 Great Lakes Nickel .42. C1076 Great Lakes Bakelite, base mount only .35. WD11 Adapter .48. 299 Bakelite Socket .42. 299 Adapter. Makes regular socket fit 299 tube .52.

GREAT LAKES SUPREME RHEOSTATS AND POTENTIOMETERS. We guarantee these rheostats and potentiometers to be unexcelled. They give perfect satisfaction under constant use. Each turn of the resistance wire is in a groove which makes it impossible to have trouble when the contact slider runs over the resistance wire. Polished turned knob, base is 2 1/4 inches and made of heat resisting material. A real value. Priced very low. C90 G. L. Supreme Rheostats, 6 ohm \$0.39. C91 G. L. Supreme Rheostats 25 ohm .42. C92 G. L. Supreme Rheostats 40 ohm .45. C93 G. L. Potentiometer, 200 ohm .52. C94 G. L. Potentiometer 400 ohm .56.

HOWARD RHEOSTATS. C1064 Howard 6 ohm Plain \$1.00. C1065 Howard 6 ohm Vernier 1.40. C1066 Howard 25 ohm Plain 1.00. C1067 Howard 25 ohm Vernier 1.40. C1069 Howard 40 ohm Plain 1.00. C1059 Howard 40 ohm Vernier 1.40. C1067 Howard 200 ohm Potentiometer 1.40. C1068 Howard 400 ohm Potentiometer 1.90.

CUTLER-HAMMER RHEOSTATS. C1061 Cutler-Hammer Vernier \$1.40. C1062 Cutler-Hammer Plain .95. C1051 Cutler-Hammer 30 ohm 1.40. C1052 Cutler-Hammer 30 ohm Resistance .25. C1063 Cutler-Hammer 200 ohm Potentiometer 1.40.

BINDING POSTS. Complete with screw and washer. All brass finished in polished nickel or with black composition top as listed. Order by number. Each Doz. C110 Large size, all nicked 9c 95c. C122 Medium size, nicked, with hole for phone tin or wire .4c 35c. C112 Medium size, black composition top .5c 48c. C120 Large size, composition top .8c 85c.

CABINETS. Fine finished cabinets with binged top, sturdily built. These make a wonderful appearance. These cabinets are made to fit panels listed below. Panels not included. See table for panel sizes. C217 6x7 \$2.40. C219 7x9 2.70. C213 7x12 3.40. C228 7x18 3.75. C224 9x14 4.65. C221 7x21 3.05. C222 7x24 4.95.

PANELS. Genuine Formica panels, to fit our cabinets. C257 6x7 3/8 \$0.59. C269 7x9 3/8 .83. C263 7x12 1.15. C268 7x18 3-16 2.33. C274 9x14 3-16 2.39. C261 7x21 3-16 2.65. C262 7x24 3-16 3.10. 3/8 inch Panel cut to size \$.01 1/2 sq. in. 3-16 in. Panel cut to size \$.02 sq. in.

CRYSTAL DETECTORS. C20 Enclosed crystal detector \$1.18. C30 Crystal Detector .59.

HOW TO ORDER. Order from this page. Please give number, description and price of the article you order to help us avoid mistakes. Total the amount of your order and send Post Office money order, certified check or draft with your order. Be sure to give your name and street address on both letter and envelope. Do not include money for transportation. We pay it except on storage "A" batteries. See ads of previous months for other items.

GREAT LAKES RADIO CO., 136 W. Lake St., Chicago, Ill.

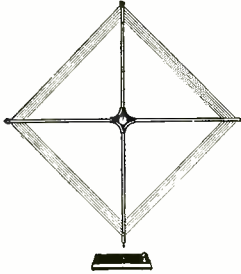

DUO-SPIRAL

The Leading Loop Aerial

The DUO-SPIRAL loop will span the continent on a loud speaker. Thorough tests by leading manufacturers and radio engineers have proved its superiority. It is trim and neat in appearance and handsomely finished. It swivels freely on its base. The wires are kept taught by hidden springs. The DUO-SPIRAL Loop completely replaces roof antenna and ground and practically eliminates static. Descriptive folder upon request.

24-inch size \$8.50 12-inch size \$7.50

TINY-TURN

A New and Superior Vernier Control

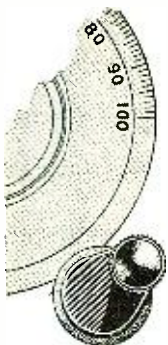

Front view of Tiny-Turn, as installed

TINY TURN greatly increases the efficiency of any radio set by securing an exactness in tuning never before attained. It has a 30 to 1 gear ratio as compared to a ratio of only 4 or 5 to 1 in the ordinary vernier. Lost motion is absolutely eliminated. The vernier turns in the same di-

rection as the dial, and can be instantly disengaged, leaving the dial free. CAN BE INSTALLED ON ANY SET IN THREE MINUTES. Handsome nickel and black finish. Packed in individual containers. Counter display board with order for ten. Folder on request.

Price 75 cents.

Our products are sold through dealers and jobbers. If your dealer cannot supply you, write us direct.

RADIO UNITS INC.

844 Webster Bldg., Chicago, Ill.
Factory: Maywood, Illinois.



Pats. Pend. Side View showing friction drive against dial

A Regenerative Loop Receiver

(Continued from page 710)

The list of materials follows:

- 1 Variable vernier condenser, 24 plate, single-plate vernier
- 1 Grid condenser and grid leak, capacity .00025 M.F. with variable leak
- 1 Phone condenser .001 M.F. capacity
- 1 WD-11 tube with socket
- 1 Rheostat (preferably vernier)
- 1 "A" battery 1½-v. dry cell
- 1 "B" battery 22½-v. small size
- 1 "C" battery 1½-v. flashlight cell
- 2 Binding posts (large size for phone cord tips)
- 3 Binding posts
- Wire for loop, approximately 100'
- Wood for center panel, loop frame, with screws, braces, etc.

The instrument panel may be of wood or composition and on it is mounted all the equipment, including "A" and "B" batteries and ear-phones, as shown in Fig. 2. The panel with tuning-control is at just the right height for operating when the loop is placed beside a chair.

The Transmitter At Station 8AZ

(Continued from page 702)

50 turns. The ribbon was cut at the 20th turn from the top, making two separate coils. The top portion is used for grid coil L2, and the lower portion of 30 turns is used for the main inductance L1. In actual operation only 18 turns are used in L2. This coil is shunted with a 23-plate condenser for fine tuning. This adjustment is very critical.

Most of the connections are self-evident and merely to give a few minor points concerning them, is all that is necessary. C3 is the grid condenser, capacity .002 mfd. R1 is a 5,000-ohm grid leak. The inductance L3 and capacity C2 are not absolutely necessary but highly desirable. By having this tuned choke there is not such a great loss of high frequency energy in the grid circuit. As much as two-tenths of an ampere increase in radiation has resulted by having this device. C2 is a 43-plate condenser and L3 is 20 turns of 20 D.C.C. wire on a 2" cardboard tube.

C4 is a glass or mica condenser, capacity .002 mfd. L4 is a 250-turn honeycomb coil used as a radio frequency choke. C6 and L5 form another tuned choke duplicate of C2 and L3. L6 is a large choke, which is specified for 250-watt tubes; however, it can be used on the smaller sets such as this. It has a strait core 2"x2"x14" built up of silicon steel sheets 14"x2", No. 29 gauge, and wound with 10 pounds of No. 20 D.C.C. wire in even layers. There are many smaller chokes available, as well as many descriptions of same that will fill the bill and will not require as much material as the choke described. C5 is of 2-mfd. capacity.

Switch SW1, when in position B, throws all four tubes in parallel. When in position A, tubes 1 and 2 are oscillators and tubes 3 and 4 are modulators for telephony. Heising modulation is used. Notice that when it is desired to use the phone, switch SW4 must be closed. This shunts out the key and closes the microphone primary circuit, L10 of modulation transformer, MT. This transformer may be purchased on the market or if one so desires he may use a Ford coil for this purpose. This gives very satisfactory service. Battery 2 is of six volts; dry-cells will do for this circuit. Battery 1 will be found to be approximately 25 volts. This



Layer Wound and Layer Insulated

Stromberg-Carlson Head Set Coils are wound a layer at a time with a wrapping of tough insulating material between layers.

This high grade construction is revealed by sawing through a section of a coil taken from the

Stromberg-Carlson

HEAD SET

It's the only head set construction which will stand up under the high plate voltages now prevalent for loud speaker hook-ups.

Therefore, it's the only head set construction which ensures permanent sensitivity.

It's a construction which is an exclusive feature of Stromberg-Carlson Head Sets.

Ask Your Dealer

Stromberg-Carlson Telephone Mfg. Co.
ROCHESTER, N. Y.



\$3 Makes your PHONOGRAPH the best loud speaker



Unscrew Head Phone Cap and Replace with Huguenot. Sizes to fit all Standard Head Phones

Fits All Standard Phonograph Tone Arms. For Special Makes Use Bushing 50 Cents Extra

HUGUENOT RADIO PHONOGRAPH ATTACHMENT

No Metal Parts to Bend or Vibrate
No Leaks or Loose Connections
Quickly and Easily Attached
Made of Black Polished Hard Rubber
Double Phone Attachment.....\$3.00
Single Phone Attachment.....\$1.00

Mail orders filled promptly on receipt of remittance. Specify make of phonograph and head-phones.

McKENZIE ENGINEERING COMPANY NEW ROCHELLE, N. Y.

Dealers—Order from Your Usual Jobber
Special discounts to the trade.

AMPLIFY WITH YOUR PHONOGRAPH

DELTA GOLD-STRIPE RADIO HEAD SETS

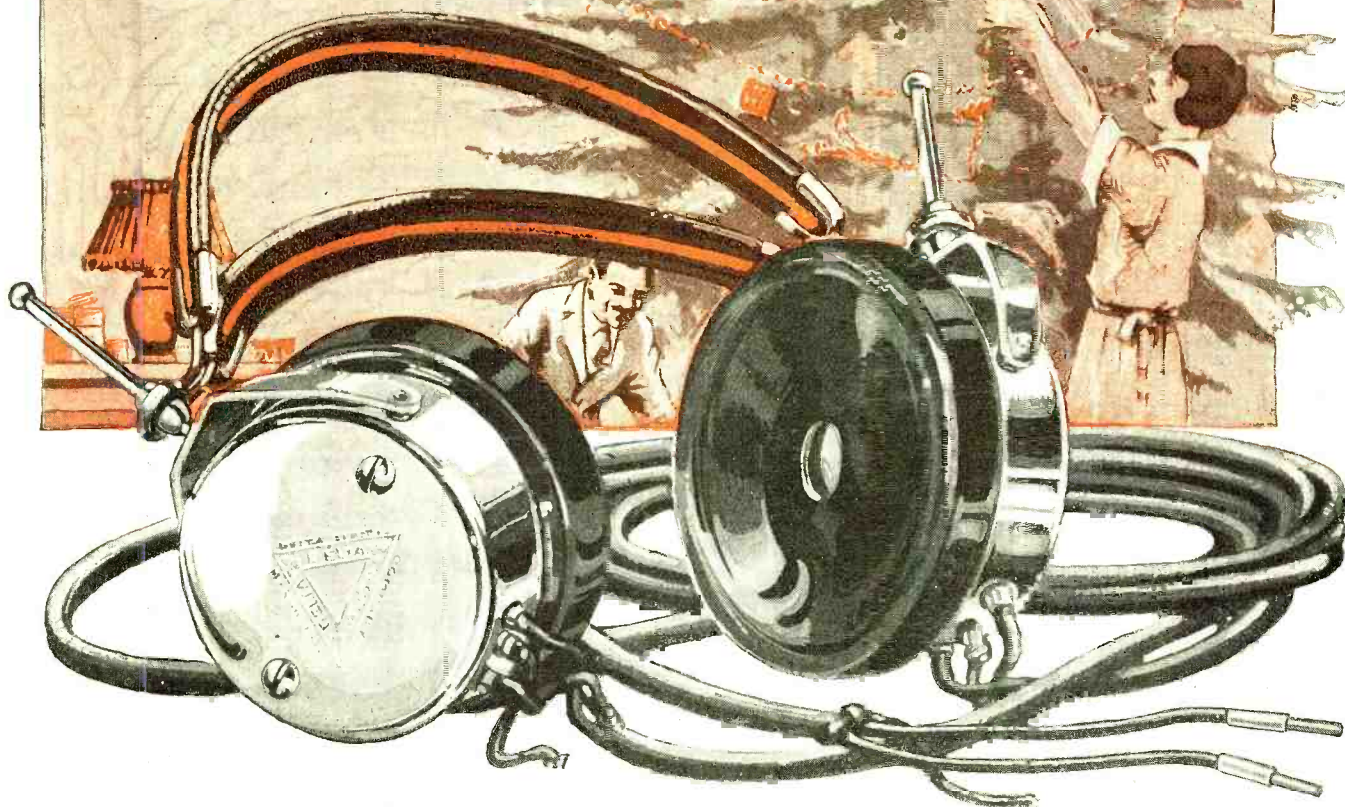

**Guaranteed Absolutely Equal or Superior to
Other Standard Makes at Much Higher Prices**

No. 500—2200 Ohms \$6.00

No. 501—3200 Ohms \$6.50

Delta Gold-Stripe Radio Headsets talk up loud and clear—perfectly tuned and matched—inspection standards very high. Satisfactory performance fully guaranteed.

The DELTA is far more beautiful in appearance—receiver cups of light brass with highly polished nickel finish—head webbing individualized by one-eighth inch gold stripe through center, and in every detail DELTA HEAD-SETS present the highest quality appearance.

MAKE MORE MONEY THIS CHRISTMAS

On volume sales and a greater margin. You'll find the Delta Gold-Stripe Radio Head Set all that's claimed—highly sensitive, unusually clear and natural in tone, comfortable fitting, light and neat appearing.

Write or Wire today for Dealer's Discounts!

DELTA ELECTRIC COMPANY

470 Delta Block, Marion, Ind.

NEW YORK CITY

SAN FRANCISCO

WINNIPEG

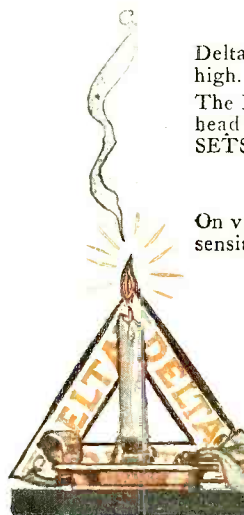

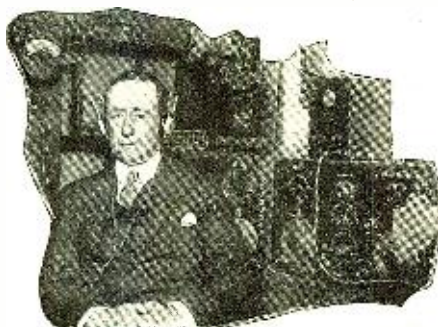

Guglielmo Marconi, as he appears today. Signor Marconi is Honorary Chairman of the Radio Institute of America.

Train for the big Jobs in Radio

There are big radio jobs waiting. Over 6,000 operators have already graduated from our school. But the radio industry is just in its infancy. There are more demands for operators than there are trained men to meet the demand.

Study at Home in Spare Time

Take a complete radio course, starting with magnetism and electricity, going straight through code and the practical operation of commercial radio. Take the same course, with the same careful grading and helpful guidance that resident students are getting. A few months' study will fit you for the U. S. Government operator's license. And you may have three weeks Post-Graduate study free in our New York Residence School.

Good Positions Are Assured
Our school is conducted by the Radio Corporation of America, the world's largest radio organization. This assures you not only finest instruction and closest touch with the most recent radio practice, but also preference for prompt placement in a good position. The pay is excellent from the beginning. The opportunity is unlimited—and entirely in your hands.

Advanced Radio Course

Great popular demand by the advanced student and experienced amateur has led to the opening of an **ADVANCED HOME STUDY RADIO COURSE**, specializing in C. W., I. C. W., telephone and radio measurements. Investigate!

Radio Institute of America

(Formerly Marconi Institute)
Established 1909

324 Broadway, New York City

Indicate by a cross X the course you are interested in:

Radio Institute of America,
324 Broadway, New York.
Please send me full information about radio opportunities today, and your
 COMPLETE RADIO COURSE
 ADVANCED RADIO COURSE

Name.....
Address.....

Write for Information Today

battery is known as the grid bias battery, the purpose of which is to maintain the grids of the five-watters at a suitable negative potential.

The filament transformer, FT has a core made up of silicon-steel No. 26. Core cross-section 1"x1", is the closed core type having a window 2½"x1½" with L7 and L8 on the 2½" sides. L7 has 45 turns of No. 12 B. & S. gauge D.C.C. wire. This winding is tapped at the 23rd turn, for center tap shown in Fig. 4. L8 has 500 turns of No. 22 B. & S. D.C.C. wire. The secondary has two small paper condensers across it in conjunction with the center tap, mentioned above. This is shown on winding L7. These condensers each have a capacity of .001 mfd.

SW3 is a combination switch and fuse block. It is used to keep this switch open when working on A.C. connections.

The tuning of the set is quite a task and there are many different ways of doing it. I shall give the method used at this station which seems to do very well. The desired wave-length may be found by inserting a small buzzer in series with the antenna and adjusting aerial and counterpoise clips till maximum sound is heard in the receivers attached, at the wave chosen. Let me suggest that the wise amateur will select a wave near the fundamental regardless of what the radiation is. By doing this your signal will be in the "Calls Heard" more frequently and you will enjoy a wholesome conversation many times that will exceed your fondest expectations. The apparatus is put in operation by closing switch SW2 to position C and manipulation of the key, K., switch SW4 being left open. After this is done the clip on conductor leading from C4 is adjusted on L1 until a reasonable indication is shown on the milliammeter, MA. (200 M.A. in my case). Care must be taken to prevent the tubes from getting too hot by reducing the generator voltage while tuning up. Then in order to secure proper exciting voltage, or feed-back to the grid circuit, the clips on L2 and the capacity C1 are varied until maximum output is indicated on ammeter AM. If the set does not oscillate at first, try reversing the leads to the grid coil, L2. Inductances L3 and L5 are tuned by their respective condensers C2 and C6. Finally the ground is adjusted until the highest amount of antenna current is obtained. If working near the fundamental, this clip will be placed very near the counterpoise lead.

It is a very hard proposition to tell how to tune a set of this nature, as the experimenter will invariably have different conditions to work under and the best method, after all is said and done, is pure grit to stick to it and fight the thing through. A young amateur with experimental ability and a bull-dog determination has the whole world to conquer.

It is hoped that the foregoing will be an outline with which many may construct a set that will "cut the ether" and that those honest hearts who have written me letters of congratulation will have the same privilege that was mine to enjoy, when they receive the report of their "sigs" a few thousand miles away.

Radio Station 4BY

(Continued from page 701)

ing a new filter system, consisting of an iron core choke of 30 henries, a by-pass condenser of two mfd. across the line before it gets to the choke, and the same immediately behind the choke, the ordinary 1750-volt "Faradon" condenser being used, three in series, six sets in parallel in front of the choke, and two

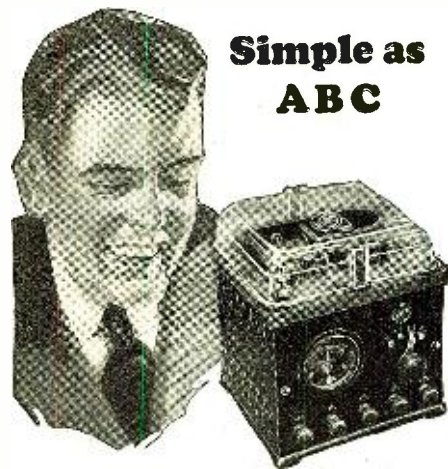

Simple as ABC

—And comprehensive, too. The new Valley Battery Charger, Type ABC, charges all Radio storage batteries—2-volt peanut tube batteries, 6-volt A Batteries, and 1 to 4 B Batteries. Also charges 12-volt batteries.

Plugs into regular electric light socket. Uses a negligible amount of current—a dime's worth for an average charge.

Unfortunately, production is limited. Don't miss out, and don't buy another until you have seen the Valley Type ABC Charger. At all good radio dealers.

VALLEY ELECTRIC CO.
3157 S. Kingshighway St. Louis, Mo.

Valley Battery Charger

Guaranteed Results!



1000 miles on loop and loud talker \$5 EACH

—with Globe two-stage radio frequency transformers. Simple in design, high in amplification, extremely selective, systematically uniform in operation. With each transformer is furnished a hook-up of a simple 3 tube set with only two controls. Here is the set you can build and be sure of best results. Also, we furnish a 4-tube hook-up that will get exceptional results. No tricky tuning. Globe transformers mark a decided step forward in radio frequency amplification. In ordering indicate for 1st or 2nd stage.

Dealers write for proposition.

GLOBE
ELECTRIC COMPANY
MILWAUKEE WISCONSIN

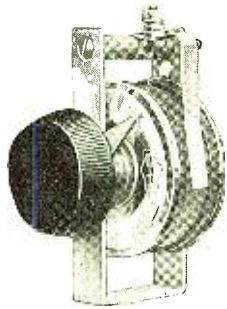

The New 125 Ohm C-H Radio Rheostat

The new UV 199 tubes can be operated direct from a 6-volt storage cell source by using this new C-H Rheostat. Many radio men are equipping their panels in this way so that either dry or storage cells may be used as desired. When operated on a storage cell with this rheostat, it is unnecessary to recharge except at long intervals due to the low current consumption of the UV 199 tubes.

Your Radio Set Deserves the Protection of This Famous Trade Mark

In every phase of the development of electrical control the famous C-H trade mark has been regarded with deserved respect. In every country in the world—in every language—this mark of approval of the Cutler-Hammer engineers has for more than a quarter of a century designated the extreme advance in design in the type of equipment on which it was inscribed.

So universal was the knowledge of C-H quality that in only a few months after the introduction of radio rheostats engraved with the famous "mark of the master builder," more than one-half million were sold. Today this same protection can be demanded for all radio control—there is a rheostat for every purpose, the Potentiometer, Grid Leak and Radio Switch, all with the C-H trade mark.

THE CUTLER-HAMMER MFG. CO.

Member Radio Section, Associated Manufacturers of Electrical Supplies

MILWAUKEE · WISCONSIN

CUTLER-HAMMER

Quality Amplification



High mu or low mu, when you amplify you must be sure that you do not distort because maximum amplification by itself does not necessarily mean satisfaction. You *should* seek maximum amplification with minimum distortion over the entire audio frequency range.

This problem has been studied for nearly a decade in our laboratory. Its result is expressed in our Type 231A amplifying transformer. Not only has this transformer a high amplification factor but the amplification is nearly uniform throughout the audio range. This flat curve makes it unnecessary to employ the cumbersome method of using different makes of transformers for 2-stage amplification. Use an engineering designed transformer. It costs no more.

Turns ratio3.7 to 1
 Impedance ratio 10 to 1

Price, completely mounted\$5.00

Send for free Educational Folder—"Quality Amplification", and Radio Bulletin No. 916N.

General Radio Co.

Manufacturers of Electrical and Laboratory Apparatus

Massachusetts Avenue and Windsor Street

CAMBRIDGE

MASSACHUSETTS

5876

ONE THOUSAND AGENTS WANTED

WE want one thousand agents to sell subscriptions to RADIO NEWS, SCIENCE AND INVENTION and PRACTICAL ELECTRICS. We will pay a generous commission for this work and help you in every way. Our three publications are leaders in their fields, ready sellers and this is an offer well worth your while. A few spare hours a day will bring you a handsome return. Write regarding our proposition at once and be the first one to get started in your vicinity.

Experimenter Publishing Co.,

HERBERT H. FOSTER, Sales Manager

53 Park Place

New York

in series, four sets in parallel behind the choke. We hope to get better results from this filter, (rectification from 4BY has been poor in the past) because of a dearth of information on this subject, and we are very much indebted to a recent radio publication for much of the information used in designing the new filter system.

The mounting of the tubes, milliammeter, and A. C. voltmeter is shown in the picture. The inductance is mounted at the top immediately behind the panel, underneath which is the filament transformer, which is also home-made. It operates directly from the 220-volt supply line delivering 15 volts and 30 amperes with no heating. The construction briefly consists of a closed iron core, having a cross sectional area of $2\frac{1}{4}$ square inches, one leg of which has the 700-turn primary wound on it, tapped at the 350th turn for use on a 110-volt supply. The secondary is wound immediately over the primary and has 68 turns of No. 10 D. C. C. wire. Variation of voltage in the transformer is secured with a primary rheostat connected in series with the supply line. Extremely fine voltage control is thus secured. It is extremely interesting to note that there is only a $1\frac{1}{2}$ -volt drop when the full 30 amperes are taken from the secondary winding. In constructing this transformer, the insulation between the

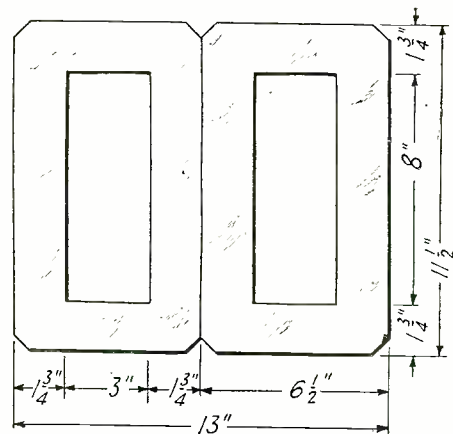

Constructional Details of the C.W. Transformer Core.

primary and secondary can not be over emphasized. We found it necessary to use two layers of mica of considerable thickness to prevent a breakdown at this point. The total cost of this transformer built along these lines should not be over \$6.

Immediately behind the filament transformer is the transmitting relay. It consists of an ordinary 4-ohm telegraph sounder with two sets of contacts arranged on an insulated arm. The main contacts close the plate circuit, the second set short circuits a resistance inserted in the filament line to compensate for the drop in voltage when the load is thrown on the line. This resistance is a very small constructional item, but very materially improves the efficiency of the set. It prevents the variation of the note as is common in many C. W. transmitters. A Weston thermo-coupled radiation meter is used to check the antenna current, which averages on high power about eight or nine amperes. A series condenser is used to cut down the effective capacity of the antenna, and when first cut in the circuit raised the radiation three amperes as it allowed the values of inductance to be raised to the proper amount.

The antenna is a very remarkable type and size for an amateur station. It is

"BUILD YOUR OWN" WITH "RASCO" PARTS!

THE Radio Specialty Company—"RASCO" for short—now in its third year, is unquestionably the oldest and most unique radio parts supply house in the United States, if not in the whole world. This Company makes a specialty of small orders. No order is too small to get immediate and prompt attention. The reason is simple: 80% of our orders are small. The reputation of this house was built upon service. Ask any of your radio acquaintances what they think of "RASCO" service, "RASCO" promptness. Thousands of unsolicited testimonials are in our files, to prove that we serve the public as it has never been served in radio merchandise before. Be sure to get our great 84-page catalog, containing over 550 different parts. Catalog contains over 350 illustrations. "WE CAN ONLY DISAPPOINT YOU ONCE." Try us with a 50c. order and make us prove what we say. Prices include delivery to your door.

We pay all transportation charges in U. S. ALL GOODS SENT PREPAID IN 24 HOURS

Order direct from this page.

NOTE BIG PRICE REDUCTIONS THIS MONTH

Money refunded if goods do not satisfy

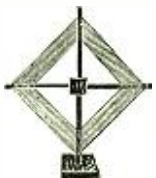

LOOP AERIAL
The loop aerial you have been waiting for. Made entirely of well seasoned hard wood. Complete with all parts and base, No. 22 enamelled wire used. Total height of loop 36", 2 feet on the side; loop is 10 convolutions. Can be put together by anyone in less than 5 minutes.

Satisfaction guaranteed. D2600 Two foot loop aerial, complete...\$1.15

STORAGE BATTERIES

New! New! New! Two volt, 40 ampere hour storage battery for use with WD11, 12, and U. S. 199 tubes. Don't keep on buying dry cells continuously. This storage battery will pay for itself in two months. Only best materials used. Guaranteed for 2 years. You can connect up to 6 dry cell tubes on a single case of these batteries. Can be recharged for a few cents. Hard rubber container encased in impregnated wood case. Due to low price and large weight of batteries, shipped express collect.

D2400 Two volt, 40 ampere hour storage battery, size 2 1/2 x 8 x 2".....\$3.90
D640 Six volt, 40 ampere hour storage battery, size 4 3/4 x 7 1/4 x 9".....7.25
D660 Six volt, 60 ampere hour storage battery, size 6 x 7 x 5 1/4".....9.50

WOOD CABINETS
Highest grade mahogany cabinets made. Best hand rubbed finish. Top is beveled. Front of cabinet rabbetted to fit panel. Price delivered to your door; no panel included in these prices.

Entire cabinet made of 1/2" well seasoned stock.
D714 Wood cabinets, panel size 7x11 1/2".....\$3.35
D718 Wood cabinets, panel size 7x13".....3.60
D724 Wood cabinets, panel size 7x24".....4.40
D710 Wood cabinets, panel size 7x10".....2.60
D712 Wood cabinets, panel size 7x12".....3.00
D721 Wood cabinets, panel size 7x21".....3.90

"RASCO" BEZELS
The finest Bezel on the market. Best brass mesh used. The Bezel comes entirely nickel plated. Will improve looks of your panel 100 per cent. Outside diameter 1". Can be used on 3/8" or 3-16" panel.

D1700 Rasco bezel.....\$1.15
D1701 Bezel 1 1/2" diam......20

UNIVERSAL BEARING
THE bearing to hold variometer and variocondenser rotors. Total length of bearing 2 1/4". Outside shaft, 1 1/4". Length of thread 1". Length of threaded sleeve, 3/4".

D1375 Bearing.....\$2.25

COPPER FOIL
Thinnest copper foil made, .001" thick. Comes 4" wide.

D5025 Copper foil per ft. \$1.10
8-1/4 ft. length......80

FORMICA PANELS
Clearance Sale. This sheeting is positively the best grade on the market. High finish on both sides. Too well known to require much explanation. Due to the fact that we are discontinuing these particular sizes, this material is now offered practically at cost. Prices are about 40 per cent lower than our catalogue list. Note also that we ship these panels prepaid.

D350 6"x12"x3-16" thick, each.....\$1.50
D352 9"x12"x3-16" thick, each.....1.75
D353 12"x12"x3-16" thick, each.....4.00
D354 6 1/2"x19 1/2"x3-16" thick, each.....1.90
D356 6"x14"x3-16" thick, each.....1.60
D357 6"x4"x3-16" thick, each......65

RASCO 180° VARIOCOUPLER
This Coupler while extremely low in price will do anything and everything that a more expensive one accomplish. Silk Wire wound on bakelite tubes. There are six in a set. Wave length of coupler is from 150 to 600 meters. Coupler is made for panel mounting. 3/4" shaft. Your money refunded if it is not all we claim.

D3100 Variocoupler prepaid.....\$1.50



MELOTONE LOUD SPEAKER
The best popular loud speaker on the market. Has tuned feature the same as all "Hico" phones. Fibre horn, heavy metal base, five foot cord. Nickel goose neck. Greatest tuned

talker. Compares favorably with most expensive speakers. Size overall 13 1/2"; horn length 11 1/2"; bell 6 1/2"; total height 9".
D255 Melotone Speaker.....\$4.90

RICO TUNED RECEIVERS
No better phones made. Super-sensitive. Awarded Radio News Laboratories Certificate of Merit. The only tuned phone on the market. Can be tuned for any intensity and sensitivity. Magnetic pole of phone is in mathematical center of diaphragm.

D666 2000 ohms, double head set, not adjustable \$3.50
D2020 2000 ohms, double head set TUNED \$4.45
D3036 3000 ohms, double head set TUNED \$5.50

"RASCO" VERNIER
Cleverest vernier made. Can be used with any dial. Soft rubber ring engages dial. Does away with variometer condenser.

We guarantee results. All metal parts moulded in best black composition. Nothing to come apart. Biggest hit of the season.
D1450 Vernier.....\$0.30

"RASCO" POSTS
DC50 Post made entirely of best black composition—3/32" screw—each.....\$0.08
D202 Post has nickel-plated bottom part, each......08
Dozen, each style......90

"RASCO" SOCKETTES
Substitute for Vacuum Tube Socket. Four of these take one Vacuum Tube. Grasp tube firmly. Best contact possible. Take less room. Are better.

D1550 Sockettes, nickeled, set of 4.....\$2.25
D1551 Sockettes, nickeled, set of 4 (to take WD-11 Tube)......25
Note: Set of 4 sufficient to hold 1 tube.

JUST OUT AUTOPLEX CIRCUIT
The famous Autoplex circuit described in RADIO NEWS has taken the country by storm. The only single tube outfit that works a loud-talker. Results guaranteed.

1-D714 Mahogany Cabinet, 7x14".....\$3.35
1-D7140 Diectrye Panel, 7x14".....1.20
2-D5353 Moulded Variometers.....6.00
2-D3076 1" Dials......80
1-D5014 1250 turn Himecomb coil.....1.95
1-D6500 Vacuum Tube Socket......35
1-D4310 4 ohm Rheostat......45
1-D714 Mahogany Cabinet, 7x14".....3.35
8-Assorted Binding Post Name Plates......25
5-D6400 Feet Ras Bar Wire......18
1-D5209 Consolidated Autoplex pattern.....50
Total \$15.83

Our special price, complete.....\$15.25

Complete with Melotone Loud-speaker \$20.00



PHONEHORN
Fills a new and distinct want. Base consists of D1310 Phonedapter described on this page into which fits a fine enameled fibre horn. Size of horn 12"; bell 6 1/2". Slip Phonedapter end on a single telephone receiver and you have the lowest priced loud talker ever made. Mounted in your set or hung in corner of room it will bring sound all over the room. A most useful article. Welcome by all radio fans.

D1321 Phonehorn, prepaid.....\$1.45

AUDIO FREQUENCY TRANSFORMERS
No better Transformer on the market. Highest class materials. Impregnated coils. Silicon steel stampings used. Save 50 per cent by assembling it yourself.

D1100 A.F. Transformer, ratio 4 to 1.....\$2.00
D1150 A.F. Transformer, ratio 6 to 1.....\$2.00

RADIO FREQUENCY TRANSFORMERS
The best Radio Frequency Transformer developed so far. Designed for us by Mr. R. E. Lacault, Associate Editor of RADIO NEWS. Air core. Guaranteed to do the work. This Transformer brings in the long distances.

D2800 Radio Frequency Transformer, size 1 1/2"x2 1/2".....\$1.50

RHEOSTATS AND POTENTIOMETERS
Highest grade Rheostat made. High heat dielectric composition. U.S.A. Wound with best non-corrosive resistance wire. Comes with tapered, knurled knob. Diameter, 2 1/2". Complete with pointer.

D4310 6 ohm, each \$4.50
D4311 30 ohms, for 914 and 201a tubes, each......65
D4312 Potentiometer, 200 Ohms, each......85

JUST OUT Cat. No. 10

SPIDER WEB FORMS
At last! Fine forms to wind your spider webs. Made from hard, well seasoned fibre. 1-1/16" thick, center and side holes for wiring. 3200 has 13 slots, 3201, 11 slots, both 5" diameter. 3201 has projection for mounting.

D3200 Spider web form, each.....\$2.25
D3201 Spider web form, each......25

BRASS RODS
Sold in 6" lengths only.

D6032 Brass Rod, 8/32" thread, per length.....\$.08
D6033 Brass Rod, 6/32" thread, per length......06
D1425 Brass Rod, plain 3/16" round, per length......10
D3610 Brass Rod, plain 3/16" round, per length......06

"RASCO" NAME PLATES
The circular plate is our new Binding Post Name Plate. Diameter, 3". These denominations: PHONES, GROUND, OUTPUT, BATTERY, LOUD SPEAKER, GRID, LOAD, "C" BATTERY, AERIAL, INPUT, "A" BATTERY, "B" BATTERY, LOOP TICKLER, PLATE, "C" BATTERY, PLACEMENT.

D6000 to 6019 Binding Post Name Plates, each denomination.....\$.03
Dozen......30



REINARTZ DUO-SPIDERWEB COIL
Here is a very fine inductance for Reinartz circuit, 200-600 meters. 19 taps. Size 4 1/4" diam.; 1 1/2" center opening. Can be used in nearly all new circuits. Construction: duospider web throughout. Coil is firm and will not fall apart as is case with many inferior makes. A few of these coils will work wonders in your set.
D2650 Spider-web Reinartz coil.....\$1.15

PHONODAPTER
The Phonedapter will fit any phone. Metal tube fits any standard phonograph. Make your phonograph a loud talker. Fits Columbia, Victor and Sonora phonographs. Is made entirely of pure soft rubber with brass tube insert.

D1310 Phonedapter.....\$4.40

DOUBLE PHONODAPTER
The Double Phonedapter fits all phonographs and will take any standard double head set, thereby making your phonograph a loud talker. Made of cast metal, nickel plated and highly polished. Has three generous soft rubber bushings.

D1320 Double Phonedapter......65

PLUGS
RASCO Telephone Plug. This is the plug that is sold from 75c. to \$1.00 everywhere. Has hard rubber composition shell and patented cord tip holder. Must be seen to be appreciated. Finest workmanship throughout.

D1030 Rasco Telephone Plug, each.....\$.35

LITZ WIRE
D823 equals No. 25 B&S, per foot.....\$.02
D880 equals No. 28 B&S, per foot......01
D891 equals No. 21 B&S, per foot......03
D892 equals No. 20 B&S per foot......04
Discounts of 10 percent in 100 foot lots.

PANEL MOUNTING VARIABLE CONDENSERS
This condenser presents the latest word in precision mechanics. Plates, washers, and all other parts are accurately machined. Positively no better condenser on the market. Shafts 1/4". Save from 40% to 60% by assembling condenser yourself. A crank can do it in a few minutes' spare time. Capacity guaranteed.

D1111 11 plate condenser, .00025 mfd. \$1.10
D1212 21 plate condenser, .0005 mfd. 1.22
D4343 45 plate condenser, .001 mfd. 1.50

The "Rasco" Catalog
CONTAINS 75 VACUUM TUBE HOOK-UPS, 350 ILLUSTRATIONS, 550 ARTICLES, 84 PAGES No. 10

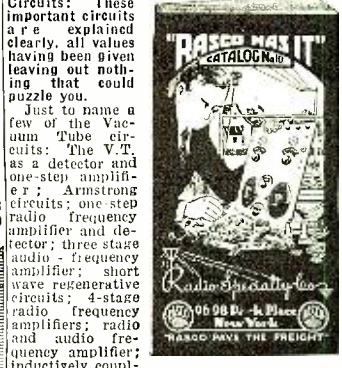

All Armstrong Circuits: These important circuits are explained clearly, all values having been given leaving out nothing that could puzzle you. Just to name a few of the Vacuum Tube circuits: The V. G. as a detector and one-step amplifier; Armstrong frequency amplifier and detector; three stage audio frequency amplifier; short wave regenerative circuits; 4-stage radio frequency amplifiers; radio and audio frequency amplifier; inductively coupled amplifier; Armstrong superautodyne, etc.

Radio Specialty Co.
98 Park Place - New York City
Oldest and Original Exclusive Radio Parts House in U. S.
Factories: Brooklyn, N. Y. Elkridge, Md.

DEALERS
Get Our Special Proposition

Sent Free Anywhere

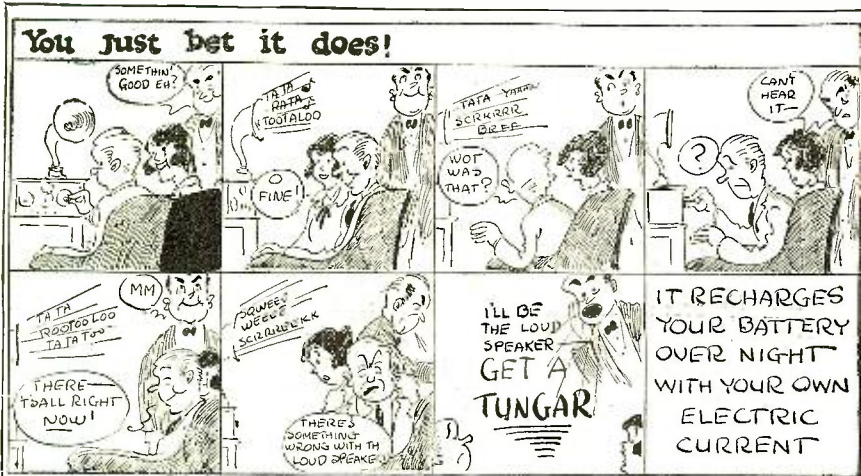

Full radio tones will not come from "empty" radio batteries

Even the finest radio instrument will not give results unless the battery is doing its full duty.

For complete and satisfying reception from near and far, no other combination equals the reliable storage battery and the Tungar for keeping it tuned up.

With Tungar in the house you are prepared for perfect reception always, without having to move the battery an inch. You renew again and again with Tungar and your regular electric light current.

Tungar attaches wherever there is a lamp socket or a convenience outlet. Just turn it on and leave it, any time, day or night. Its cost of operation is low. There are no moving parts to get out of order.

For years motor car owners have used Tungar for charging their automobile batteries. See one at any good electrical shop, or write for literature. Address Section RA 12.

Merchandise Department
General Electric Company
Bridgeport, Connecticut

Tungar Battery Charger. Operates on Alternating Current.

(Prices east of the Rockies)

2 Ampere Outfits Complete—\$18.00

5 Ampere Complete—\$28.00

Special attachment for charging 12 or 24 cell "B" Storage Battery—\$3.00

Special attachment for charging 2 or 4 volt "A" Storage Battery—\$1.25

Both attachments fit either Tungar



35A-104D

A GENERAL ELECTRIC PRODUCT

an eight-wire vertical fan, the top of which is 105' above the ground, on a wooden mast. The top spreader is 17' long, and is insulated by an 18" Electro-se insulator. The lower spreader is 6' long, and from this the 8' lead-in is taken. The antenna has no obstructions for a mile or more around it, other than one-story wooden roofed houses, and the 105' can be considered the effective height. A tuned counterpoise and ground complete the antenna system. The counterpoise is composed of 17 wires 51' long, insulated from the ground, and connected to the ground lead through a tuning inductance, which is used to adjust it to the same wave-length as the ground system. The ground system consists of copper strips buried over the whole area of the lot, which is 50' by 120' to a depth of 6' or 8'. The ground lead is of rather novel construction, and as the set is on the second floor of the house is about 20' long. It is made up of a center strip of 2" copper ribbon, and on each side of the ribbon has three antenna wires for the reduction of the radio frequency resistance. The radiation resistance of the antenna system is about 12 ohms and was measured by the comparison method, of substituting a dummy antenna of

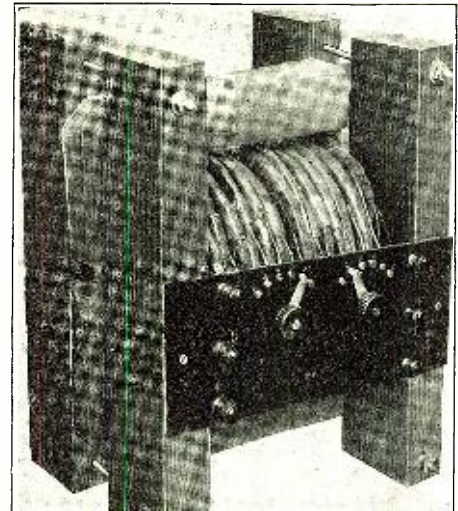

A Photo of the Completed C.W. Transformer. Switches Are Provided for Voltage Selection. Note the Simple Method Employed for Mounting the Transformer.

known value for the actual antenna and computing the resistance from that. In using the formula "I²R" where "I" indicates the amperes in the antenna, and "R" the radiation resistance, with proper corrections it was found that 4BY was putting about 450 watts into the antenna system.

Some very fine distance records have been worked from this station, one or two of which are worthy of mention. During the month of December, 1922, this set, at that time putting only four amperes in the antenna, was reported in various parts of Europe 15 times in the one month. An acknowledgement card was recently received from a California amateur who mentioned that "Every time 4BY opened up, a half dozen sixes called you". We have been receiving cards continually from the West Coast, so that it has been definitely proven that the station is working consistently with that part of the country, which in the end is the only DX worth while, as freak night work is not worth so very much in comparison with this stable record.

At this time the operating personnel consists of the owner, J. E. Hodge, who signs "JE" and the writer, P. G. Watson who signs "BV".

WHY PAY MORE?



6 Volt 80-100 Amps \$14.00

6 Volts 100-120 Amps \$16.00

2 YEAR GUARANTEE
INDESTRUCTIBLE
RUBBER CASE

Service Batteries are manufactured for Radio only, by battery men who know radio. We guarantee Service Batteries to

IMPROVE RECEPTION

If after 30 days' trial you do not find this to be the best battery value on the market today, return to us and we will gladly Refund Your Money. Shipped by express C.O.D. day order is received. 5% Discount for Cash with Order.

SERVICE BATTERY CO.
704 East 102nd St., Cleveland, Ohio

SALESMEN

Largest radio publishing organization in the world, wants salesmen, either whole or side line, to sell an assortment of 20 books to the trade.

Liberal commission to hustlers.

Box 233, RADIO NEWS
New York City.

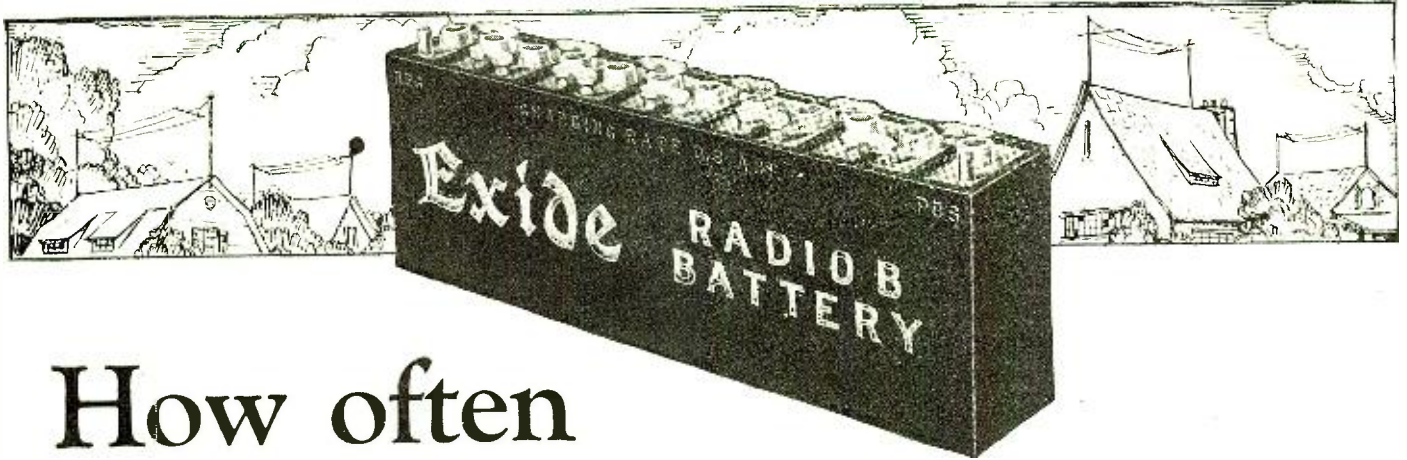

How often do you get a new B battery?

THE current from a B battery is relatively small. But it must be always on the job. B batteries that run down quickly are the bane of the radio fan's existence. Your B battery can help you get the most pleasure from radio, or it can be your greatest nuisance. It all depends on the kind of battery you buy.

The wise radio amateur knows it pays to get a good B battery in the first place. And that means an Exide. The new Exide B Battery is built with extra-heavy plates. That is one reason why it lasts so much longer than the ordinary battery. It can be recharged again and again, saving you the annoyance of frequent replacements.

Exide B Batteries give steady, noiseless current. They are strangers to the hissing, frying noises caused by internal discharge. The 12 cells are encased in rubber, with special vents to allow gas to escape when the battery is being recharged. They are designed throughout to prevent electrical leakage.

Two low-voltage A batteries

If your set operates on low-voltage tubes, it will be worth your while to examine the new Exide two-and four-volt A batteries. They are right in line with the latest developments in radio receiving. The one-cell Exide A Battery will heat the filament of a 1.1 volt .25 ampere tube for 96 hours; the two-cell Exide A

Battery will heat the filament of a 3 volt 60 milli-ampere tube for approximately 200 hours. They are specially adapted to WD-11 and UV-199 vacuum tubes.

The Exide A Battery for six-volt tubes gives full-powered, care-free service. It requires only occasional recharging. Like all Exide Radio Batteries, it is built of the finest materials available, is sturdy and long-lasting.

When you hook up your set with Exide A and B Batteries, you are sure of getting maximum signal strength. You can reproduce broadcast selections in clear bell-like tones.

Wherever reliable storage batteries are required, you will find the Exide doing its work ungrudgingly. It is recognized as the leading storage battery in every field of industry. A majority of all government and commercial wireless plants are equipped with Exide Batteries.

Don't let inefficient batteries spoil your pleasure in radio. Go to any radio dealer or Exide Service Station and ask for Exide Radio Batteries.

If your dealer can't supply you with free booklets describing the complete Exide line, write direct to us.

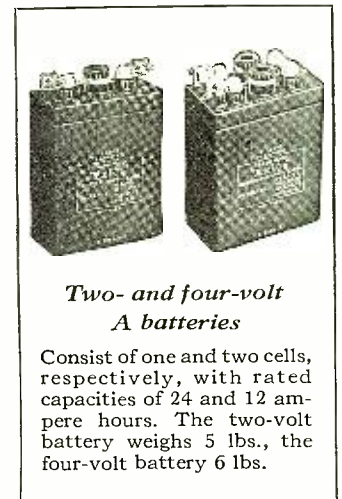

Two- and four-volt A batteries

Consist of one and two cells, respectively, with rated capacities of 24 and 12 ampere hours. The two-volt battery weighs 5 lbs., the four-volt battery 6 lbs.



Exide A Battery for six-volt tubes
Supplies uniform filament current. Is dependable and long-lasting. Comes in four sizes, of 25, 50, 100 and 150 ampere hour capacities.

Exide

RADIO BATTERIES

THE ELECTRIC STORAGE BATTERY COMPANY, PHILADELPHIA

Oldest and largest manufacturers in the world of storage batteries for every purpose

Service Stations Everywhere

Branches in Seventeen Cities

Pioneer

Distance
—unusual distance—has been gotten by using a Pioneer Variocoupler and a plate and grid variometer.



Pioneer Variocoupler \$7.00

Selectivity. 16 taps on the variocoupler gives exceptional close tuning and selectivity. Stations can be cut out and brought in at will. Interference is entirely eliminated.

The instruments have been awarded the highest award by all the testing laboratories.

Made of moulded Bakelite, moulded in our own factory under our own personal supervision.

The hardware is the best obtainable; the contacts are positive and will not become disconnected through use or wear. Instruments are made for table or panel mounting.

Binding posts on each instrument for ready and quick connections.



Pioneer Variometer \$6.50



PIONEER RADIO CORPORATION

301 Pioneer Avenue Galesburg, Illinois

Branch Offices:

European Branch Office—London, Eng., 27-28 Anning Street	Gaston E. Marbaix, European Manager
New York City	220 Fulton Street
Chicago, Ill.	33 South Clinton Street
Kansas City, Mo.	208 Baltimore Building
Minneapolis, Minn.	705 Plymouth Building
San Francisco, Cal.	623 Larkin Street

New Radio Patents

(Continued from page 726)

recognized by radio engineers, and others skilled in the electric arts.

The present invention relates, primarily, to certain improvements in the transmitting circuits employed in systems of the character above referred to, and is based upon the discovery that if a vacuum tube relay, of sufficiently high power, is inserted in the transmitting circuit it will deliver to the antenna circuit voice-frequency energy of such augmented strength as to materially increase the distance over which reliable telephonic communication may be maintained.

At the transmitting station I employ a transformer, having in its primary circuit an amplifier the input of which is voice controlled through the instrumentality of a telephone transmitter. The secondary terminals of the transformer are connected to an antenna circuit.

At the receiving station there may be an amplifier and telephone receiver connected to said amplifier, the input terminals of this amplifier being connected to the antenna and antenna circuit.

ELECTRIC DISCHARGE DEVICE

(Patent No. 1,456,505. Issued to William A. Kroop, of Brooklyn, and Paul P. Cioffi, of New York, N. Y., May 29, 1923.)

The invention relates to electric discharge devices and a method of manufacturing the same. It has for an object the provision of an electric discharge device in which the need for a glass support for the electrodes in the form of a cane or arbor is eliminated.

A further object is the provision of such a caneless or arborless electrode mounting as shall provide a rigid and compact electrode unit.

The invention in general comprises a plurality of electrodes which are mounted on a rigid wire frame which is connected to the usual press or squash and are by means of the arrangement of the frame rigidly spaced thereon from each other and the walls of the tube.

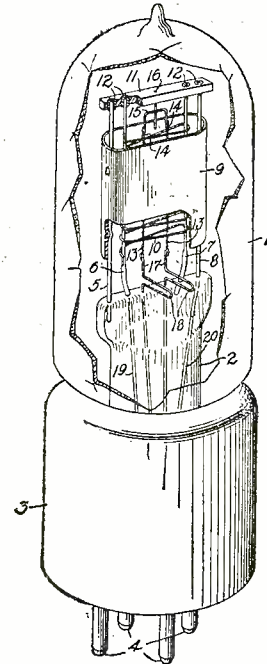

While in the preferred form of the invention, rigid wires are used as frame members, nevertheless a rigid frame providing the same degree of compactness and rigidity may be provided by the use of glass or other members in place of the wire members.

The invention is illustrated in the drawing which represents in a part elevation, part section view, a preferred form of tube embodying the invention.

The invention as shown in the drawing comprises an evacuated vessel 1 having the usual press or squash 2 sealed in the lower end thereof. A socket of well-known type 3, is attached to the lower end of the evacuated vessel 1 and has terminal plugs 4 attached to its lower end. Four rigid heavy wires 5, 6, 7 and 8 of any suitable material, are imbedded in the upper surface of a press 2 and extend vertically in a spaced parallel relation toward the upper end of the evacuated vessel 1. To the wires 5 and 8 at suitable points intermediate their ends, is welded a cylindrical anode 9 which has substantially an oval cross-section. This anode is of nickel and is welded to the wires 5 and 8 along its inner surface. A spiral grid 10 of nickel wire is placed within the cylindrical anode 9 and is welded along opposite sides to the wires 6 and 7. The upper end of the wires 5, 6, 7 and 8 are inserted in apertures in a block of lavite



RADIO NEWS
Amateurs' Handibook
by the most eminent Radio Experts

EXPERIMENTER PUBLISHING COMPANY, INC.
NEW YORK

PRICE, \$1.00

JUST THE BOOK YOU WANTED

“Radio News”

Amateurs' Handibook

Volume No. 1

Check full of radio constructive and instructive articles from cover to cover. Written by foremost radio authorities, in plain everyday language which everyone can understand. Sections include articles on Receiving Sets and Sundry Apparatus, Transmitters and Accessories, Radio Theory, Vacuum Tube Data, and Practical Hints for the Amateur. A book which also serves as a ready reference and should find a place in the library of every amateur. It contains 224 pages and over 375 illustrations, diagrams, and photographs, bound in a multi-colored heavy board.

On sale at all leading radio stores. If your dealer cannot supply you, pin a dollar bill to this ad and write your name and address in the margin below, and book will be forwarded to you postpaid.

EXPERIMENTER PUBLISHING CO., INC.
53 PARK PLACE, NEW YORK



Another Dictograph Achievement

\$8

3000 Ohms

The new Aristocrat Model Dictograph Headset is the ultimate in radio headset production. In it is combined twenty years' experience in the production of sensitive sound transmitting devices—300,000 people use the Acousticon for the deaf. The famous Detective Dictograph—the Dictograph System of 'Telephones—the Dictogrand Loud Speaker, are all standard of the world for quality and results.

The New Aristocrat Model is made with improved hard rubber caps — orange and black finish — the genuine have black and red cords.

IF YOUR DEALER CANNOT SUPPLY YOU — GET IN TOUCH WITH US DIRECT.

DICTOGRAPH PRODUCTS CORPORATION

220 West 42nd Street

Executive Offices

New York, U. S. A.



THE IMPORTANCE OF VARIABLE CONDENSERS



NEARLY all modern receiving circuits contain one or more variable condensers. Upon the performance of these vital parts depends largely the degree of success of your receiving set. It is easy to produce condensers which look efficient, but effectiveness in these parts is much more than skin deep.

CHELSEA VARIABLE CONDENSERS

Enable any receiving circuit to give its best. Plates are die cast into solid units giving permanence of electrical and mechanical connections and rigidity at all times. This is the only sure method of construction which avoids corrosion and insures low resistance. Insulating material is the best obtainable—genuine bakelite—molded by Chelsea. This insures low electrical losses. Large brass self-aligning bearings eliminate all play and maintain the proper air gap at all times. Plates are of heavy stock of the proper design. These are some of the reasons why you should use Chelsea condensers to achieve the results you hope for.

Made in eleven styles, they form a complete line in which there is the proper type and capacity for any receiving circuit.

Prices from \$2.50 to \$6.75

OTHER QUALITY CHELSEA PARTS

Variometers with Vernier	\$8.00	Rheostats	\$1.00 and \$1.40
Variocouplers	8.00	Tube Sockets50 and .75
Audio Transformers	\$3.75 and 4.50	Dials40, .45 and .50

Write to Department 7 for our large catalog, which illustrates and describes the complete line of Chelsea Receiving Sets and Parts



11. The apertures in the block are counter-sunk at both ends and are slightly larger in diameter than the wires inserted therein. A suitable cement 12, preferably of lead borate is fused into the counter-sinks and around the wires to form a tight joint between the lavite and the nickel wire.

A filament 13, formed of any suitable material but preferably of platinum coated as known in the art with suitable chemicals comprises two wires disposed in parallel relation, the upper ends 14 of the wires being held in respective ends of a U-shaped yoke member 15. This yoke member 15 is welded at its upper end to a wire 16 which is rigidly imbedded in the lavite block 11 and supports the filament. The lower ends of the filament 13 are connected to lead-in wires 17 which have formed in their length a loop 18. The loop 18 provides means for conducting current to the filament and at the same time, by means of its resiliency, maintains the filament under constant tension and in proper spaced relation. The lead-in wires then extend downwardly through the glass press and are connected to suitable terminals 4. This filament is adapted to carry only .2 of an ampere at a pressure of 2 volts. The wires 6 and 8 are likewise connected respectively to lead-in wires 19 and 20 connected with suitable terminals 4. The rigidity of the wires 5, 6, 7 and 8 and the connection of their upper ends to the lavite block 11 supports the electrodes as a unit which is rigid, and the spaced relations of which are constantly maintained.

Audio Frequency Amplification

(Continued from page 693)

coupling resistances R1 and R2. Therefore, points A and B are at high positive potentials, but since these are the points at which the amplifier tubes are coupled from the plate of one tube to the grid of the succeeding tube, it is necessary to prevent the high positive plate potential from being applied to the grid, as otherwise the rush of current to the grid would cause damage to the tube, and might ruin it. This may be avoided by the very simple expedient of using a blocking condenser. This condenser permits the audio frequency voltage to pass through to the grid, but prevents the direct plate voltage from passing to the grid. For best results this condenser should have a fairly high capacity. A value of 0.1 microfarad would be very satisfactory.

It will be found that very often better results can be secured by the use of a negative potential on the grids of the amplifier tubes. The exact value of this varies with the type of tube used, but is probably somewhere between minus one and minus three volts. It is best to try different values choosing the one which gives most satisfactory results. It is desirable to apply this negative potential in some cases through a high resistance leak r1 and r2, of about 1/2 megohm. This is necessary in such tubes as the WD-11 and WD-12. Here again a simple trial will tell at once.

The amplification of tubes increases considerably with the value of the applied voltage on the plate of the tube, hence the larger this is made the better. It is not desirable to exceed the maximum value given by the manufacturers. Also, in the case of resistance coupled amplifiers such as the above, there is a further limitation. The plate battery is applied through a very high resistance R1 and R2. Hence there is a fairly large voltage drop across this resistance. The result is that the effective voltage applied to the plate is much under the plate battery voltage. To increase this to large values would mean that excessive plate batteries would have to be employed which is not very desirable. For this reason it is also not desirable to make the plate coupling resistances R1 and R2 too large, for then the effective plate voltage is cut down still more. By keeping to values given above, the amateur will have the best values con-

You owe yourself good radio training. In radio operating the man who knows

A R C-SPARK-VACUUM TUBE

sets is directly in line for a good position. Our course goes to the very heart of Radio. Experienced teachers. Fully equipped laboratory. Dormitories.

Write to the nearest school for information and booklet

Y. M. C. A. RADIO SCHOOLS
 NEW YORK SEATTLE LOS ANGELES
 158 East 86th St. 4th Ave. Y. M. C. A.
 St. Madison St.

SEND FOR YOUR FREE COPY

TESTED HOOK-UPS

SUBMITTED BY USERS OF OUR



WONDERFUL TRANSMITTER

BUTTON FOR LOUD SPEAKERS

Price \$1.00
 POSTPAID
 with instructions

AMPLIFICATION AND EXPERIMENTS

K. ELECTRIC CO.

15 PARK ROW

NEW YORK

INSIST ON FADA NEUTRODYNE PARTS

To successfully construct Neutrodyne circuit radio receivers requires special parts called "Neutrolons" and "Neutroformers."

These two FADA parts and especially the "Neutroformer" must have very critical electrical constants. Values of inductance, high frequency resistance, coupling coefficient, and mutual inductance are of extreme importance.

FADA engineers working for the past year in close cooperation with Professor Hazeltine have designed FADA Neutrodyne receivers and special Neutrodyne parts that function efficiently. The radio experimenter using such FADA parts and the FADA "How to Build It" book can build satisfactory home-made receivers using the Hazeltine Neutrodyne Circuit.



The FADA set of Neutrodyne parts pictured above consists of three "Neutroformers", two "Neutrolons" and a thirty-two page book—the most comprehensive information on Neutrodyne receiver construction published. The total cost only \$25.00.

The five tube Neutrodyne receiver pictured below was built using FADA parts and instruction book. Such a receiver, having two stages of tuned radio frequency amplification, vacuum tube detector, and two stages of audio frequency amplification will bring in both local and long distance broadcasting stations (from 1000 miles and over) with extremely good loud speaker volume and with a pleasing purity and clarity of reproduction.

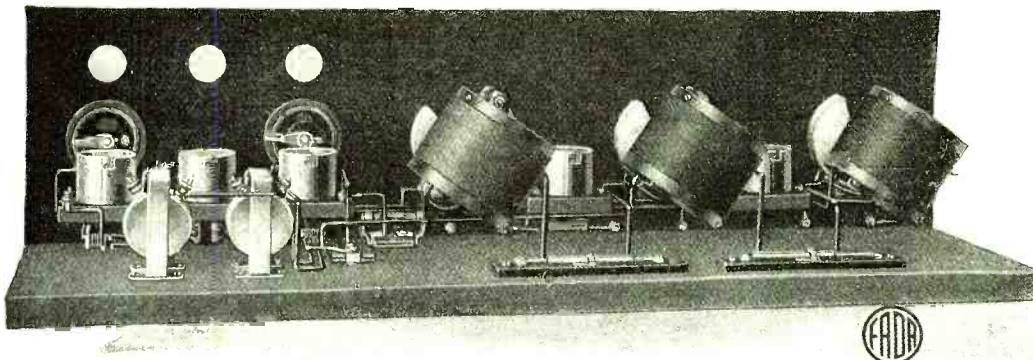

For the first time, knock-down sets of radio receiver parts have been successfully marketed. Parts for both four and five tube Neutrodyne sets are supplied complete to the last screw and including drilled and engraved panel and wooden base-board. Everything except the cabinet is supplied. This four tube set of parts (including the Neutrodyne parts) costs \$64.00 and the five tube set \$65.60.

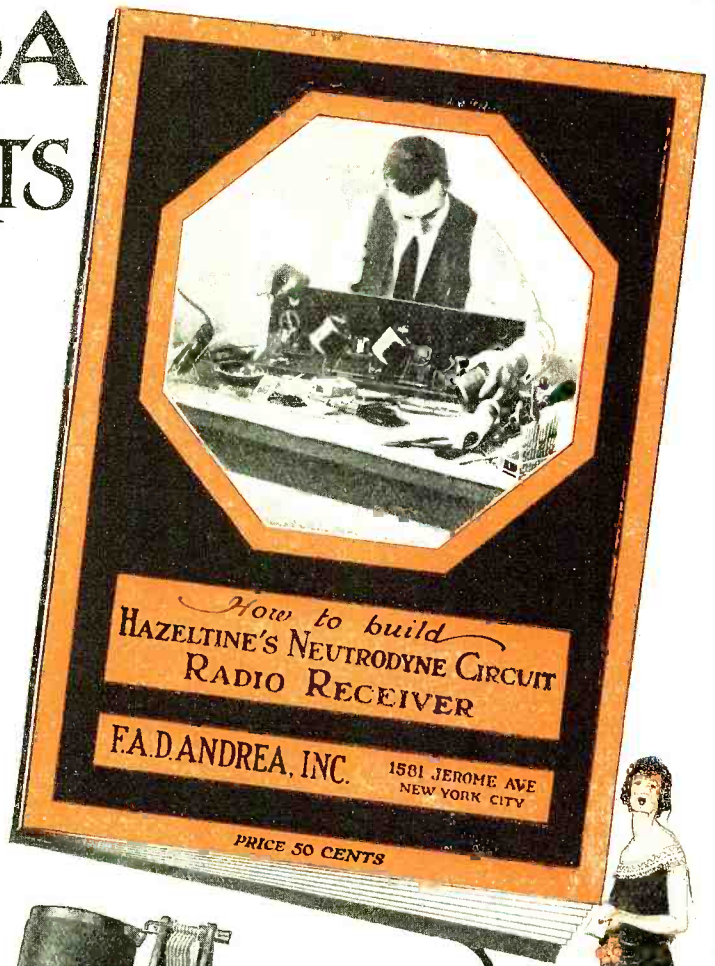

FADA "Neutroformers" consist of a variable air condenser and a very specially designed radio frequency transformer. Calibrating the "Neutroformers" in each set of parts insures practically identical dial settings of the completed Neutrodyne receiver.

FADA "Neutrolons" are very special variable condensers having a capacity of approximately 1 to 10 micro-microfarads. All high frequency losses are reduced to a low minimum in these FADA neutralizing capacities or "Neutrolons."

Send right now for the



"How to Build it" Book

F. A. Andrea, Inc.,
1581-A Jerome Ave.,
New York, New York.

Enclosed is 50c for a copy of "How to Build Hazeltine's Neutrodyne Receiving Set." If this book is not exactly as represented money will be refunded.

Name.....

Address.....

City..... State.....

F.A.D. ANDREA, INC.
MANUFACTURERS OF RADIO EQUIPMENT
1581-A Jerome Ave.  NEW YORK CITY

"American Beauty"

Electric Soldering Iron



The
Best Iron
Made

For Soldering all connections, parts, etc. Ready for use by attaching to any electric light socket. The cost of operation is insignificant.

Many thousands in use by amateurs, engineers, manufacturers, telephone companies and many others.

For radio, telephone and all light work our latest Model No. 3138 is ideal; also two larger sizes for doing heavier work.

For twenty-eight years our name and trade mark have been a guarantee of quality and dependability.

AMERICAN ELECTRICAL HEATER COMPANY
DETROIT, U. S. A.

Oldest and largest exclusive makers. Established 1894

TO THE RADIO DEALER.

Let us explain how you can make the sale of our publications a worth while, well paying part of your business. Every one that enters your store is a prospective buyer of RADIO NEWS. RADIO NEWS will sell with little effort on your part.

You may sell our publications on a single copy basis with a fine margin of profit or on a subscription basis with a generous commission allowance.

Write now and prepare for the Fall and Winter trade.

EXPERIMENTER PUBLISHING CO.,
53 Park Place, New York.

sistent with maximum amplification and minimum plate battery. The exact value of plate voltage to use depends upon the tube. WD-11 and WD-12 tubes can safely take about 60 volts, UV-201A about 60 to 90 volts, etc. The rating of the manufacturer is a safe guide.

This type of amplifier has two very great advantages: First, it is practically distortionless. It reproduces very faithfully all the signals impressed on it and the output is a faithful copy of the input. This is a very important consideration, for the broadcast listener desires to hear speech and music as it is actually sent out, and not garbled and distorted beyond recognition. The resistance amplifier faithfully reproduces speech and music. However, unless care is taken to have the negative potentials on the grid, it is possible that distortion will occur. Second, the resistance coupled amplifier does not oscillate or howl. Some amplifiers have a tendency to oscillate of their own accord at audio frequency, and as a result loud noises are heard which interfere with reception and which distort the incoming speech and music. The resistance coupled amplifier does not have this tendency and may be used as high as four and five stages without howling. For the very particular amateur there is nothing better than a distortionless resistance amplifier, which gives a very high quality signal; it is superior to anything else as far as actual quality is concerned.

REACTANCE COUPLED AMPLIFIERS

The reactance coupled amplifier is very similar in construction and design to the resistance coupled amplifier, as seen in Fig. 3, in which is shown the two-stage inductance coupled amplifier. The only difference is that in place of the plate coupling resistances R1 and R2, we have substituted the plate coupling inductances or reactances L1 and L2. Otherwise the construction is the same as for the resistance coupled amplifier. In this case the amplified voltages are developed across the reactances L1 and L2 and are then applied to the grid of the succeeding tube to be again amplified. For maximum amplification it is necessary that the reactance of L1 and L2 at every frequency be two or three times the resistance of the amplifier tube, just as for the resistance coupled amplifiers. This requires an inductance of the order of at least 10 to 20 henries. In the case of the impedance coupled amplifier, therefore, to secure this value of inductance it is necessary to use iron core coils.

The use of iron often results in some distortion being produced, although this may be made very small by getting well designed inductances. It has a very marked advantage over the resistance coupled transformer, in that because it is an inductance coupled affair the inductance is high, but the resistance of the inductance is small, relatively. Hence there is only a very small voltage drop across the inductance and the total effective voltage on the plate of the amplifier tube is practically the entire plate battery voltage. The amplification will then be greater for the same battery voltage, and excess battery supply is thereby avoided. Plate inductances are made by standard companies and well designed apparatus may be secured for this purpose.

All the other constants of the inductance coupled amplifier are practically identical with those employed in the resistance coupled amplifier. The grid condensers should be about 0.1 microfarad, the negative grid voltage should be between 1 and 3 volts, sometimes



AMRAD

Panels are Exclusively Formica

AMRAD is a name that is well known in the American radio industry.

Amrad has produced large quantities of equipment for the United States Government and for the public.

It means something that Formica panels are used exclusively in Amrad sets.

The fact that Formica works well with tools; that its finish is always perfect and uniform; that it improves with age, and does not warp or discolor, makes the material popular with manufacturers, dealers, and amateurs alike.

Formica service is the best in the business

THE FORMICA INSULATION COMPANY

4618 Spring Grove Avenue, Cincinnati, Ohio

Sales Offices

50 Church St., New York, N. Y.
422 First Ave., Pittsburgh, Pa.
1042 Granite Bldg., Rochester, N. Y.
415 Ohio Bldg., Toledo, Ohio

1210 Arch St., Philadelphia, Pa.
1819 Lyndale Ave., S. Minneapolis, Minn.
Sheldon Bldg., San Francisco, California
Whitney Central Bldg., New Orleans

414 Finance Bldg., Cleveland, Ohio
9 S. Clinton St., Chicago, Ill.
313 Title Bldg., Baltimore, Md.
47 King St., Toronto, Ontario

FORMICA

Made from Anhydrous Redmanol Resins
SHEETS TUBES RODS



BROADCASTING

TRANSMITTING delicate electrical currents has been highly developed. Receiving them as sent is vital to your enjoyment.

No matter how efficient your receiving set may be, it rests with the headphones you buy to transform these currents into sound. Beautiful, clear and distinctive tones of music or spoken words cannot be reproduced by inferior headphones.

Twenty-five years of research and painstaking manufacture by the Holtzer-Cabot Electric Co., has produced for you the supersensitive No. 2 Universal Headset.

This light weight, sanitary set reproduces positively and faithfully with an exceptional purity of tone and extreme sensitiveness.

Holtzer-Cabot No. 2 Universal
The supersensitive phone

Holtzer-Cabot No. 4 National

The quality phone at a minimum price
Be sure to send for a copy of our booklet "What you should know about Radio Reception."

THE HOLTZER-CABOT ELECTRIC CO.

125 Amory Street, Boston, Mass.
1161-65 South State Street, Chicago, Ill.
Department D

Holtzer-Cabot
BUSINESS ESTABLISHED 1875

HEAD-SETS

ONE THOUSAND AGENTS WANTED

WE want one thousand agents to sell subscriptions to RADIO NEWS, SCIENCE AND INVENTION and PRACTICAL ELECTRICS. We will pay a generous commission for this work and help you in every way. Our three publications are leaders in their fields, ready sellers and this is an offer well worth your while. A few spare hours a day will bring you a handsome return. Write regarding our proposition at once and be the first one to get started in your vicinity.

Experimenter Publishing Co.

HERBERT H. FOSTER, Sales Manager

53 Park Place

New York

applied through a $\frac{1}{2}$ -megohm leak, this to be determined by trial for any particular tube.

TRANSFORMER COUPLED AMPLIFIERS

The last type of audio frequency amplifier to be considered is shown in Fig. 4, namely a two-stage transformer coupled amplifier. In this case iron core transformers are used to couple one stage to the next, as shown on the diagram. This system has the same advantage over the resistance coupled amplifier that the inductance coupled amplifier has, namely, since the transformer primary windings have very low resistances there is a very small voltage drop through them and the entire plate battery voltage is practically applied to the plates of the amplifier tubes. Hence, maximum amplification is secured as far as the best value of plate voltage is concerned and plate battery is conserved. But it has a further advantage over both the resistance and inductance coupled amplifiers as far as actual amplification is concerned; both are limited in their ability to amplify.

By the nature of these systems the most they can amplify is the amount of the inherent amplification of the tube itself. Thus, suppose we have a WD-11 tube which has an amplification constant of 6. This means that the tube can amplify a signal six times and no more. The resistance and inductance coupled amplifiers, if properly built as outlined above, will not be able to amplify more than the theoretical six times, and generally it would be only four or five times. However, the transformer coupled amplifier amplifies the same four or five times in the primary of the transformer, and then steps this up by the amount of the transformer step-up ratio. Suppose we are dealing with a good standard make of audio frequency transformer which has a ratio of 4 to 1. Due to the amplifying properties of the tube itself we have amplified the incoming signal four or five times, already as much as either the resistance coupled or inductance coupled amplifier. Then we immediately amplify this amplified signal four more times because the audio frequency transformer has an amplification or step-up ratio of 4, hence the total amplification 16 to 20. Thus we see that the transformer coupled amplifier gives very much more amplification than either the resistance or inductance coupled amplifier.

Actually, the above theoretical maximum amplification is generally not secured, and in practice it is found that the maximum amplification is somewhat under that given by the transformation ratio of the transformer. It is, nevertheless, greater than that secured by either resistance or inductance coupled amplifiers. As a result, it is seen that the same amount of total amplification may be secured with less stages in the transformer coupled amplifier than with resistance or inductance coupled amplifiers. For ordinary loud speaker operation it is generally sufficient to use two stages of transformer coupled tubes. For the same amplification using resistance or inductance coupled tubes it would be necessary to use three stages. The saving when using transformers is immediately apparent.

While it is entirely possible to use three or even four stages of resistance coupled amplifiers without any difficulty, it is not possible to do so with transformer coupled amplifiers. In the first place, as with transformers, there is a tendency on the part of the amplifier to oscillate or howl, when amplification is very great, as the smallest bit of coup-

Loud, clear radio or "muffled" sounds?

The importance of using the proper transformer

TENS of thousands of radio owners, by the Acme method, now know what it means to have radio concerts that are truly loud and clear, perfect reproductions of the original broadcasted concerts. Even stations from 500 to 3000 miles away are now clearly heard.

The results have been marvelous. Loud, clear radio concerts are now received with sets which once seemed capable of producing only faint, weak or distorted, almost unintelligible sounds.

Radio and sound engineers, after long research have perfected two instruments which, together, insure maximum volume, clarity and distance. First they designed a special type of amplifying transformer which does not distort

over the voice and musical range. Its 4.25 to 1 ratio allows its use with any vacuum tube made.

This is the Acme A-2 Audio Frequency Amplifying Transformer. Used in one stage of amplification (consisting of a vacuum tube, the Acme A-2 itself and certain minor apparatus) it produces strong, clear sig-

nals in any head set. When two Acme A-2's are used, an Acme Kleerspeaker or other loud speaking device will give clear, undistorted music.

Gives any set greater range

Then they have perfected a second instrument which gives any set greater range. It builds up the strength of the incoming radio waves before they are acted on by the detector. So signals from far distant stations (which have never before been of sufficient strength to cause the detector to act) can now be secured—and with the aid of Acme A-2's turned into loud, clear, undistorted concerts. This second instrument is the Acme Radio Frequency Amplifying Transformer, and is made in three types, R-2, R-3 and R-4, for more than one stage of radio frequency amplification.



Distortion—like a clothespin on his nose—muffles the singer's voice

Send for booklet

In order to secure the best results with Acme Transformers, which are sold in all radio stores send for "Amplification without Distortion," which not only explains how to secure the best results with your own set, but also has wiring diagrams helpful in building a set. Amplification and distortion are clearly explained, and methods of remedying poor results are described. The book also explains how to get Audio and Radio Amplification on the same vacuum tube—the "REFLEX" System. Send ten cents for your copy. Acme Apparatus Company, Dept. 22, Cambridge, Mass., U. S. A.



The Acme A-2 Audio Transformer (shown) and Acme R-2, R-3, and R-4 radio frequency transformers sell for \$5 each. For prices on special transformers and coils for any type of business, send specifications to factory.

ACME

~ for amplification

ACME APPARATUS COMPANY, Dept. 22,
Cambridge, Mass., U. S. A.

Gentlemen:—Enclosed find ten cents (U. S. stamps) (U. S. Coin) for "Amplification without Distortion."

Name

Street

City State

RADIOGEM

The Dollar Radio Receiving Set

The Simplest Radio Outfit Made—Yet as Practical as the Most Expensive!

You need know absolutely nothing about wireless to operate and enjoy the RADIOGEM. It is so sturdy, so simply constructed that it is small wonder radio engineers who have tested it have pronounced the RADIOGEM a brilliant achievement. The RADIOGEM is a crystal radio receiving set for everyone at a price anyone can afford.

Why The RADIOGEM Can Be Sold For Only \$1

Here's the secret: The RADIOGEM Construction eliminates all unnecessary trimmings, cabinets and the like, which do not play any part in the operation of a set. You receive the RADIOGEM unassembled, together with a clearly written instruction book, which shows you how to quickly and easily construct the set, using only your hands and a scissor. The outfit comprises all the necessary wire, contact points, detector mineral, tube on which to wind the coil, etc., etc. The instruction book explains simply and completely the principles of radio and its graphic illustrations make the assembling of the RADIOGEM real fun. Remember the RADIOGEM is a proven, practical radio receiving set and will do anything the most expensive crystal set will do.

The RADIOGEM is the Prize Winner of the Age

Out of hundreds of radio models submitted recently in a great nation-wide contest, radio engineers, the judges, unanimously chose the RADIOGEM as the winner—the simplest radio-receiving set made! And the RADIOGEM costs you nothing to operate; no form of local electricity is required.

Send Postage Prepaid on receipt of \$1—stamps, money-order or check.

Order Your Radiogem To-day—
or send for Free Descriptive Circular

DEALERS

The RADIOGEM is the wonder item of the radio age. It is storming the country, for the RADIOGEM'S price is so low everyone is able to buy one. Write immediately for full particulars before that shop across the street beats you to it.



Hear the programs of the Broadcasting Stations on the RADIOGEM



\$1 without PHONE or AERIAL (Patent Pending)

What They Say About RADIOGEM

I am enclosing herewith \$1.00 to pay for the Radiogem. I had it carefully wound by your wireless operator and find that it works beautifully—fully as good as any crystal set we know of.

Radiogem received, which we assembled and were very much astonished at results obtained and the clearness and volume of tone produced.

The greatest distances I heard on one of your sets is 1000 miles, having heard W.V. at Schenectady, N. Y. I think your set is the best I have ever sold at any price.

On an aerial 150 feet long and 20 high one of my customers has heard WOC and WHB, KSD, WM on one of your sets using a Peerless headset.

Herewith P.O.M.O. amt. \$1.00 for another "RADIOGEM." The one received is O.K. Placed about 15 ft. of picture cord under front porch and grounded to a gas meter, and heard the Sacramento Bee and Sacramento Broadcasting Union much better than with my large crystal set.

Your RADIOGEM RECEIVER is a wonder. I have received every station in Philadelphia with it much louder than with a high-priced crystal set.

Your two Radiogem sets received last night, and one was wired up for testing. WOC is about 40 miles away, and their signals could be heard with headphones on table. After they quit KYW at Chicago about 170 miles east was heard. Every word could be plainly heard here. WMC at Memphis, Tenn., could also be easily heard and understood.

We find that this set does a great deal more than you claim for it. We took W.E.A.R. on our audion set last night; this being the Baltimore American Broadcasting station, and then out in the Radiogem and got excellent results. After the Baltimore concert was over, we continued to use the audion set and about ten o'clock were listening to W.E.A.R.—New York—and a little later we disconnected the audion set entirely and hooked up the Radiogem, very clearly hearing both piano music and announcement of name of station and its location.

You claim a radius of 20 miles over your "Radiogem" is sometimes a possibility. You should adhere to the truth. I constructed one for my mother, installed it with an aerial, and she listens not once in a while, but at her will, to Schenectady, Newark, New York, or Providence, R. I., and her home is Attleboro, Mass. I can't give your set too much praise.

(Names and Addresses on Request)

ling between tubes is sufficient to start it howling when the amplification becomes excessive. In the second place, tube noises are introduced. There are always present certain irregularities in tube operation, which become evident as a change in plate current, which ultimately causes a noise in the telephones. These changes are very minute and hence are not very noticeable in the phones when the amplification is kept below a certain point. As the amplification increases, these noises become more and more evident, and when too much amplification is used they may become so loud as to interfere with reception of signals. It is, therefore, not recommended that more than two stages of audio frequency transformer amplification be used. This is quite sufficient for most reception purposes.

Unless the best type of transformer is used, distortion is very likely to result. Transformers with high ratios do not respond equally well to all the frequencies in speech or music. They may increase some frequencies or diminish others in varying proportions. Hence the signal output may be very different from the signal input, and no advantage is gained in the long run by buying transformers whose only virtue is cheapness. The best audio frequency transformers have a ratio of about 3 to 1 or less.

To sum up the discussion of audio frequency amplification it may be fairly stated that the resistance coupled amplifier is preferable to the inductance coupled amplifier. As between transformer coupling and resistance coupling there are two chief considerations: For as nearly perfect quality as is obtainable, the resistance amplifier is the best; it gives the most faithful reproduction of broadcast signals obtainable, but will require more tubes for any given amount of amplification. The transformer coupled amplifier gives pretty good reproduction and is quite satisfactory for most purposes; it has the advantage of requiring the smallest amount of equipment for a given amplification. The resistance coupled amplifier would be suitable for reception where extreme accuracy in reproduction is required, as in signal or speech comparisons; this is recommended to those who are very particular. For practical purposes the transformer coupled amplifier will do very well.

The Clariphone

(Continued from page 683)

ing disadvantage of the application of this interference-eliminating device to the copying of radio messages, it would seem, is its action in reducing the strength of the wireless signals when atmospheric disturbances or other extraneous voices are not prevalent.

The Naval Radio Research Laboratory, until recently located at the Bureau of Standards, reported that "It has been found that an enormous amount of amplification is necessary to give a signal in the 'Clariphone' equal to the intensity of the signal received on the receiving set with one tube." This handicap was overcome, however, by the construction of a four-stage radio-frequency amplifier-detector and two-stage audio-frequency amplifier. This electric circuit afforded signals of the necessary intensity. Comparative tests were made between the signals received in the ordinary telephones using an oscillating detector, a Marriott's tuned telephone, and the Scott "Clariphone" with the amplifying circuit referred to above.

JUST THE BOOK YOU WANTED

"Radio News" Amateurs' Handbook

Volume No. 1

Check full of radio constructive and instructive articles from cover to cover. Written by foremost radio authorities, in plain everyday language which everyone can understand. Sections include articles on Receiving Sets and Sundry Apparatus, Transmitters and Accessories, Radio Theory, Vacuum Tube Data, and Practical Hints for the Amateur. A book which also serves as a ready reference and should find a place in the library of every amateur. It contains 224 pages and over 375 illustrations, diagrams, and photographs, bound in a multi-colored heavy board.

On sale at all leading radio stores. If your dealer cannot supply you, pin a dollar bill to this ad and write your name and address in the margin below, and book will be forwarded to you postpaid.

EXPERIMENTER PUBLISHING Co., Inc.

53 PARK PLACE, NEW YORK

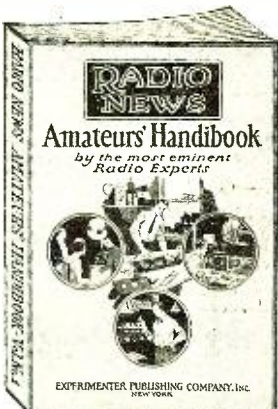

PRICE, \$1.00



The size you want— the insulation you need

YOU don't need to wait while your panel is cut to order when you get ready to build your radio set. Just go to your dealer and ask for a Celoron Radio Panel. He will give you, without a moment's delay, the exact size you want. And—what is more important—you get the proper insulation for successful results in radio receiving.

Celoron is recognized by radio experts as the best material for insulation purposes. Its high dielectric strength makes it the ideal panel material.

Used by leading manufacturers

Many of the leading manufacturers of radio equipment use Celoron in making their standard parts. It is approved by the U. S. Navy Department Bureau of Engineering and the U. S. Signal Corps.

Celoron Radio Panels come ready-cut in eight standard sizes, selected to meet the needs of the set-builder. Each panel is neatly wrapped in glassine paper to protect the handsome surface.

Celoron panels are readily worked with ordinary tools at home. They are easy to machine, saw, drill, and tap.

Ask a radio dealer for one of the following standard sizes:

- | | |
|-----------------|------------------|
| 1—6 x 7 x 1/8 | 5—7 x 18 x 3/16 |
| 2—7 x 9 x 1/8 | 6—7 x 21 x 3/16 |
| 3—7 x 12 x 1/8 | 7—7 x 24 x 3/16 |
| 4—7 x 14 x 3/16 | 8—12 x 18 x 3/16 |

We also furnish Celoron in full-sized sheets, and in tubes, and can cut panels in special sizes when desired. If your dealer hasn't yet stocked Celoron panels, ask him to order for you, or write direct to us, indicating by number the size you want.

Send for free booklet

"Tuning in on a New World" is the title of a booklet we have prepared especially for the radio fan. It contains a list of the leading broadcasting stations in the United States and Canada, an explanation of symbols used in radio diagrams, and several popular radio hook-ups. This booklet will be sent without charge, on request.

To radio dealers: Send for special dealer price list showing standard assortments

Diamond State Fibre Company

BRIDGEPORT (near Philadelphia) PENNSYLVANIA

BRANCH FACTORIES AND WAREHOUSES
BOSTON CHICAGO SAN FRANCISCO

Offices in Principal Cities

In Canada: Diamond State Fibre Company of Canada, Limited, 245 Carlaw Ave., Toronto

CONDENSITE CELORON STANDARD RADIO PANEL

Want two more hands?

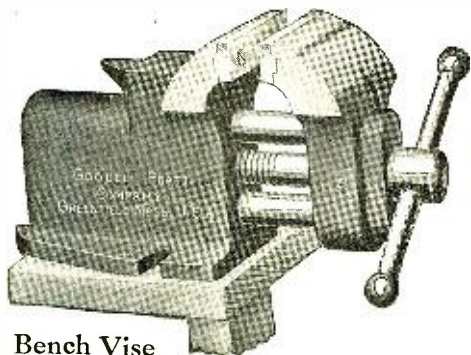

**Bench Vice
No. 168
Price, \$7.00**



Mr. Punch says:

"A work-bench without a good vise is almost as lacking in equipment as a saw without a handle."

THEN put this Goodell-Pratt Vise on your work-bench. It's the equivalent of having two more hands, for it will hold any piece of work tight and rigid.

The only bench vise made with two-guide-rod construction. These steel guide-rods are pressed into the movable steel jaws and run in long reamed holes back under the small anvil. Jaws open 2½ inches. Weight 10 pounds.

Iron parts are finished in red and black enamel; steel parts are polished.

Other tools for radio enthusiasts

If you like to tinker with radio equipment, you'll find in the Goodell-Pratt line of 1500 Good Tools the very tools made for that kind of work.

The design, workmanship, and finish of all Goodell-Pratt Tools make them splendid investments for men who love good tools.

Write for Catalog No. 15. It illustrates and describes the Goodell-Pratt line. You ought to have a copy.

GOODELL-PRATT COMPANY

Toolsmiths

Greenfield, Mass., U. S. A.

GOODELL PRATT

1500 GOOD TOOLS

FAVORABLE SIGNAL-STATIC RATIO

The results of these tests indicated that the device described in this article afforded a higher percentage of audible signals than either of the other two methods. Atmospheric disturbances, it was observed, were appreciably suppressed and when such an otherwise discordant factor was present, it did not interfere with reception of the radio communications. The officer in charge of the Naval Radio Research Laboratory picturesquely states: "Static in the 'Clariphone' resembles light, muffled hammer blows on a wooden block." To further quote this report: "One disadvantage in the 'Clariphone' is that when the instrument is properly tuned for best reception, the signal becomes very resonant and the dots and dashes tend to run together and make the signal difficult to read, although very little 'static' interference is present to hinder the signal reception. It is the inventor's belief that this can be remedied by inserting an extra part which he intends to do as soon as possible."

The present design of "Clariphone," consisting as it does of 10,240 bits of mechanism and weighing approximately 200 pounds, is costly to produce. The inventor tells the writer, that once quantity production of the instrument is effected, it is contemplated that the cost of manufacture will be reduced to a figure that may be measured by the purse-strings of the rank and file of radio enthusiasts. Meanwhile, the "Clariphone" will be given experimental application in Government and commercial radio laboratories, in contemplation of its wonderful possibilities. Speaking of these, to quote an official of the Navy Department: "The development of a proper input circuit, as outlined in this article, no doubt will bring to the radio world one of the most advanced methods ever tried for the elimination of 'static' or atmospheric disturbances."

PROGRAM FOR BROADCASTING WEATHER FORECASTS AND REPORTS BY RADIO—ILLINOIS SECTION.

90th Meridian Standard Time.

All Telephone Except Great Lakes.

NAJ, Great Lakes: (telegraph) 9.15 a.m. (4650 meters arc)—morning state forecasts, lake forecast, general forecast, general weather conditions, national weather-crop summary on Wednesday, April to October, inclusive; 4.00 p.m. (600 meters spark)—special warnings; 9.30 p.m. (1988 meters arc)—evening state forecasts, lake forecast, general weather conditions.

KYW, Chicago: (345 meters) 11.00 a.m. (12.00 noon after termination of local "Day-light Saving")—morning local forecast, state forecasts, lake forecast; special warnings at 2.15 and 4.15 p.m.; 9.25 to 9.30 p.m.—evening local forecast, state forecasts, lake forecast. Monday, "silent night."

WAAF, Chicago: (286 meters) 10.30 a.m.—morning local forecast, state forecasts, general forecast, general weather conditions, aviation forecasts, shippers' advices during winter season, national weather-crop summary and state summaries on Wednesday during crop season; 12.30 p.m.—repeats the 10.30 a.m. information, also weekly outlook issued on Sunday.

WDAP, Chicago: (360 meters) 9.30 a.m.—morning local forecast, state forecasts; 10.00 p.m. or later, at end of regular program—evening local forecast, state forecasts, lake forecasts, general forecast, general weather conditions. Monday, "silent night."

WOC, Davenport: (485 meters) 11.00 a.m.—morning local forecast, state forecasts, river forecast, general weather conditions,

LOUD SPEAKING CRYSTAL SET



At Last

You can add a loud speaker to any crystal set by using the STEINMETZ Amplifier costing only \$8.50. Guaranteed to operate on any kind of crystal set regardless of what type it is, or we will refund your money.

By using your crystal set with this amplifier music is brought in as clear as a bell and can be heard all over the room. Amplifier uses dry cell tube. Write for our complete catalog and also information on a highly efficient detector and two-stage amplifier at \$22.50.

STEINMETZ WIRELESS MFG. CO.
Manufacturers and Engineers
5705 Penn Ave. Pittsburgh, Pa.



Unequaled
Clearness
Through
New
Magnetic
Principle of
Construction.

*Circular
on request.*

Moss-Schury Mfg. Co., Inc.
Radio Division
2011-2015 Franklin St., Detroit, U.S.A.
Manufacturers of precision electrical devices

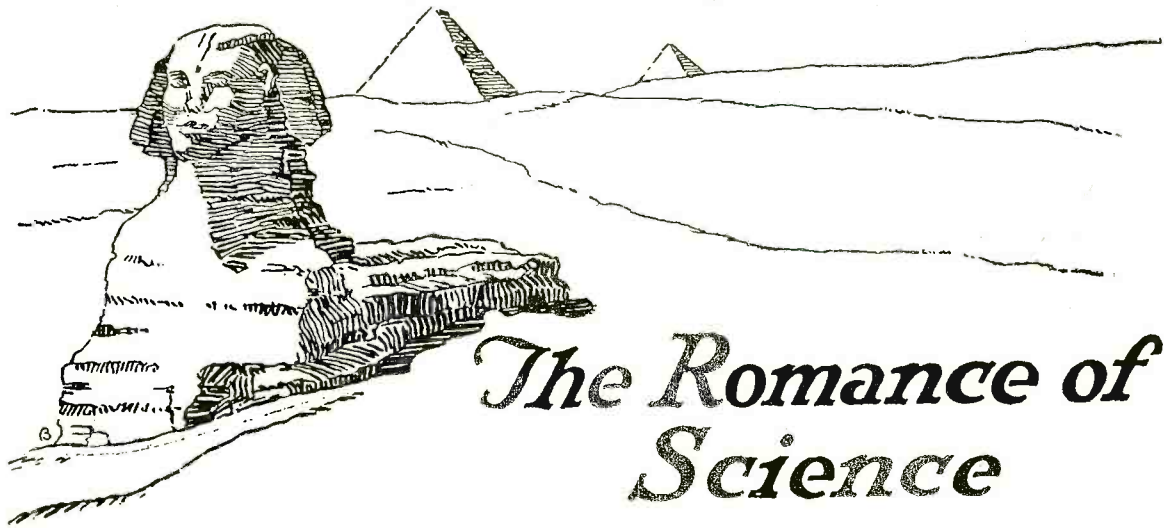

The Romance of Science

CONQUESTS of science were the real achievements of Egypt's rulers. Instead of physical prowess, they sought the laurels of intellectual supremacy. Battles became experiments. Physics, astronomy, alchemy became the chessmen of their leisure. Where other nations plunged into wars and devastation, the Egyptians gave over their vigils to the investigation of natural phenomena.

To symbolize this intellectual power and their ability to create, they conceived the Sphinx, and with unparalleled skill and persistence engraved their triumph on the face of History.

If you assemble your radio parts from plan or book, take time to drink in the romance of radio art. Know on what laws the perfection of your receiving set depends. To acquire such knowledge is not a boresome study, but an

absorbing recreation. As you read, you will understand the impelling appeal of science which has ever tempted Masterbuilders to create craftsman-like products which are more than adaptations of existing designs.

By understanding the scientific basis of radio phenomena, you will begin to appreciate what every radio engineer knows concerning condensers: — that there are no condensers equal to Cardwell's.

Cardwell rotor-grounded condensers afford entire absence of body capacity effects and permit fine tuning of the most distant stations. They have such infinitesimal losses, no laboratory has been able to measure them. Their mechanical ruggedness insures long usage and freedom from annoying difficulties. Not only will Cardwells often add a thousand miles to your receiving range but they permit the entire elimination of interference.

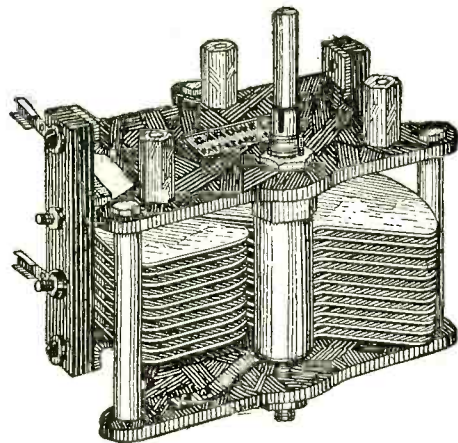

**For Egyptian Nights' Entertainment,
Read: "Cardwell On Condensers."
Sent on Request.**



Prices Vary From Three To Three Hundred Dollars

Sold Only Through Responsible Dealers

RADAK R4

Complete Regenerative Receiver

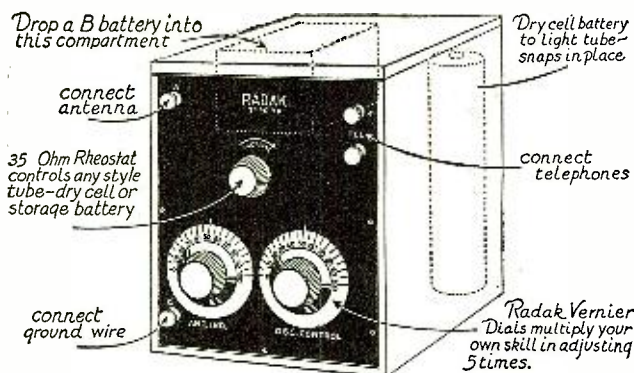

Licensed under Armstrong U. S. Patent 1,113,149

PRICE \$25.00

A newly designed and thoroughly tested circuit of superior capability, solid mahogany cabinet, genuine Formica panel, remarkable Radak Vernier dials, all batteries inside the cabinet with overall size of but 6 x 8 x 10 inches.

Where else will you find these earmarks of quality in a set selling for \$25.00? The new Radak "Governing Capacity" controls regeneration with surprising ease. Radak R4 is a self-contained set designed for use on dry cells and operating over a range of wave-lengths of 225 to 550 meters. Wherever you are, or wherever you go, you can take this set with you. Merely slip in a flashlight battery, a small "B" battery and a 3-volt vacuum tube, connect to a wire hung out the window, thrown over the limb of a tree or even laid on the roof if no antenna is available, and programs from considerable and often surprising distances may be received in a few minutes from the time you start. While easily carried to your summer home, camp, or on your vacation, the R4 is in no sense a portable or makeshift outfit, but its high quality of finish and workmanship will grace the most refined surroundings.

R4 Set complete, as illustrated and described, without accessories\$25.00

A4 RADAK 2 STAGE AMPLIFIER EXACTLY MATCHES THE ABOVE SET.....\$25.00

From the R4 at \$25.00 to the C64 five tube radio frequency set at \$220.00 THE BASIS OF RADAK SUPREMACY lies in the fact that Radak sets are an engineered entity not a mere assembly of parts. Complete bulletin of all models sent on request.

Manufactured by

CLAPP-EASTHAM COMPANY

107 MAIN STREET, CAMBRIDGE, MASS.

New York, N. Y.
395 Broadway

Cleveland, Ohio
Caxton Bldg.

San Francisco, Cal.
709 Mission St.

state weather-crop summaries on Wednesday; special cold wave warnings.

WJAN, Peoria: (280 meters) 9.15 a.m.—morning local forecast, state forecast, shippers' forecasts; repeated at 11.30 a.m. and 3.00 p.m.

WEW, St. Louis: (261 meters) 10.00 a.m.—morning local forecast, state forecasts, general weather conditions, river forecasts; special warnings at 5.00 p.m.

KSD, St. Louis: (545.1 meters) 10.40 a.m.—morning local forecast, state forecasts, general weather conditions, river forecasts and stages; special warnings at 12.40 p.m., 1.40 p.m.; 10.00 p.m.—evening state forecasts.

Amateurs receiving weather forecasts are requested to advise of the quality of service received.

U. S. Dept. of Agriculture Weather Bureau
Springfield, Ill.

CLARENCE J. ROOT, Meteorologist.

Detector and Amplifier Supplied With A. C.

(Continued from page 721)

It can be adapted to nearly any circuit that uses A. C., and may be used without the potentiometer with better results than if the potentiometer is used alone.

One section of the secondary of a Ford coil is used, connected across the phones; the center is filled with core wire. It is possible to use the secondary without taking it out, but it will not cut out as much hum. A condenser is connected in series with the phones. It is important to have the right size condenser because, while a smaller one will cut out more hum, it also reduces the incoming signals, and a larger one will not increase the signals, but will increase the hum.

Using the circuit, I can hear the Los Angeles Times, a 400-meter station, all over the room, and with a two-stage amplifier, all over the house. Every night during the listening period I get San Francisco, Salt Lake City and San Diego loud enough to understand. The tube I used first was an old Audiotron, but since then I have tried Radiotrons and Cunninghams with nearly as good results.

Contributed by William Goodall.

Outline of the Problem of Radio Control

(Continued from page 718)

neutral position when neither of the two magnets is actuated. In this position the aluminum pulley is not touching either of the small pulleys. With this combination of pulleys the desired steering speed was obtained. The small rubber pulleys were made of rubber tubing and were forced over a 3/8" shaft. The mean diameter of the pulleys was then about 1/2".

Steering is accomplished by means of a cord which winds up on one side and unwinds on the other side of the steering spool and is connected at its ends to the opposite sides of the front axle. The front wheels are normally kept in the straight ahead position by two springs. When the car is in motion the power of the steering apparatus is sufficient to overcome the unavoidable friction. The one big point which must constantly be kept in mind is the reduction of friction. The front wheels were mounted in the best possible manner. All the bearings were made of cast iron and carefully lined up, until everything ran smoothly. The car is propelled by a small shunt motor operating from

JUST THE BOOK YOU WANTED

"Radio News" Amateurs' Handibook Volume No. 1

Check full of radio constructive and instructive articles from cover to cover. Written by foremost radio authorities, in plain everyday language which everyone can understand. Sections include articles on Receiving Sets and Sundry Apparatus, Transmitters and Accessories, Radio Theory, Vacuum Tube Data, and Practical Hints for the Amateur. A book which also serves as a ready reference and should find a place in the library of every amateur. It contains 224 pages and over 375 illustrations, diagrams, and photographs, bound in a multi-colored heavy board. On sale at all leading radio stores. If your dealer cannot supply you, pin a dollar bill to this ad and write your name and address in the margin below, and book will be forwarded to you postpaid.

EXPERIMENTER PUBLISHING CO., INC.

53 PARK PLACE, NEW YORK

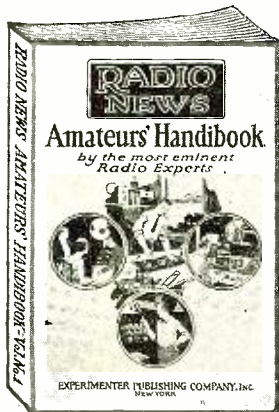

PRICE, \$1.00

ATWATER KENT

RADIO EQUIPMENT

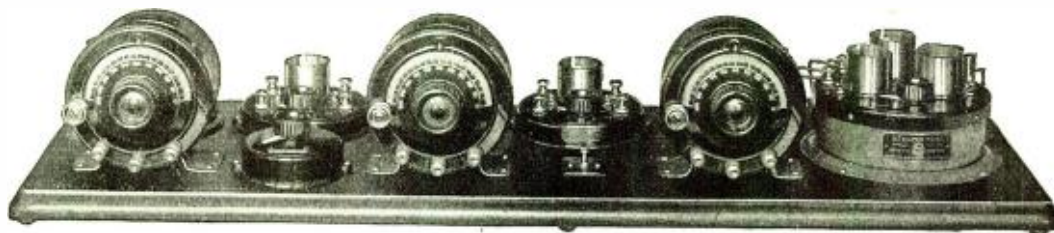

The Atwater Kent Radiodyne Receiving Set

THE Radiodyne Receiving Set is the latest achievement of the ATWATER KENT research Laboratories. With this set you will enjoy many surprises due to its remarkable performances in radio reception.

Unusual volume and clearness of tones are easily obtained from distant points. Despite its wide range this instrument is exceedingly simple to operate.

When the dial positions have once been noted on a Radiodyne Receiving Set, the operator can tune in the desired broadcasting station at will.

~ ~ ~

The ATWATER KENT Loud Speaker will give you a new conception of clear reproduction:—the true gift of the broadcasting artist is brought undistorted into your home. It is the result of painstaking research of many models, and almost endless tests and experiments.

ATWATER KENT Equipment embraces a variety sufficiently wide to meet the requirements of every user of radio:—it includes complete sets and every instrument necessary for the assembling of sets from tuner unit to loud speaker.



*The Atwater Kent Loud Speaker
Requires no Batteries*

*Literature describing the entire line of Atwater Kent
Radio Sets and Parts sent on request*

ATWATER KENT MANUFACTURING COMPANY, PHILADELPHIA, PA.
4943 STENTON AVENUE

Makers of
THE WORLD'S HIGHEST GRADE IGNITION
STARTING AND LIGHTING

WESTINGHOUSE

CRYSTAL CASE "A," "B" and "C" BATTERIES

For all radio requirements

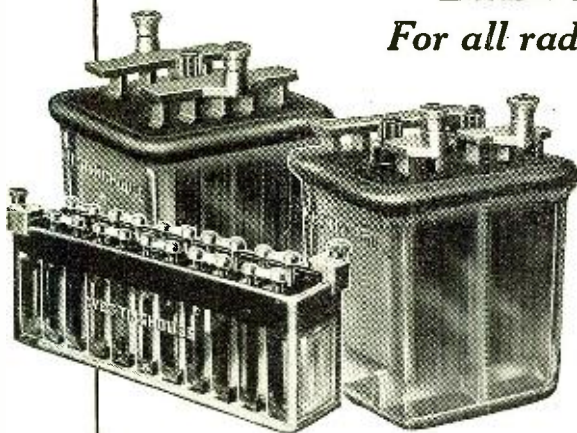

Better Batteries— Better Radio Reception

Every radio fan knows the importance of sustained battery voltage in a radio receiving set. A sudden drop in filament voltage, for example, is exasperating. Right here the name Westinghouse becomes significant. As in automobile batteries, Westinghouse Radio Batteries are the finest Westinghouse can build. The new **CRYSTAL CASE** types are especially efficient. Even-powered, slow-discharging, you'll quickly note their superiority for fine tuning, signal holding and sound volume. So economical, too! They last indefinitely and are easily recharged at a few cents' cost.

CRYSTAL CASE "A" Batteries—One-piece glass case with solid glass cell partitions and plate rests. Visible interior. 2, 4 and 6-volt sizes. **CRYSTAL CASE "B" Batteries**—The 22-MG-2 (22 volts) is a wonder for steady, noiseless, full-powered service. Rechargeable, of course. Larger types, too. Also "C" batteries in 6-volt units.

WESTINGHOUSE UNION BATTERY CO.
Swissvale, Pa.



RADIO FANS

Tune in on station
WEAF (New York)

every Thursday at 8.50 P. M. and listen to a story or article selected from

HEARST'S INTERNATIONAL

This is one of the most popular weekly features "on the air!"

FREE

Write for free copy of Radio Reprint No. 1—it contains a complete Cappy Ricks story by Peter B. Kync. Address Radio Editor, 3-A, Hearst's International Magazine, 119 West 40th Street, New York City.

PRECISION RESISTANCE UNIT



Insure
Clear and silent operation with Fixed Resistances. Correct resistances of known value must be used for clear, distortionless reception. Each Unit individually calibrated. Our interesting discount schedule mailed to jobbers on request.

DAVEN RADIO CO.,
144 Bleecker Street, Newark, N. J.

a 12-volt storage battery. This motor has a normal no-load speed of 1,200 R.P.M., but this is considerably less under load. In order to obtain the necessary power from the motor with the desired reduction of speed, helical reduction gears with a six to one ratio, were used. Thus, using 8" driving wheels and assuming the motor speed to be 1,000 R.P.M. under load, the driving axle would then turn 166.66 revolutions per minute. Since the circumference of the driver is a little over 2', the car's speed is about six miles per hour. This speed is, however, faster than the actual, as the car has to carry an abnormally large load.

The antenna system used on this car consists of a three-wire flat top in the shape of an inverted V; the total height is about 5'. The body which is of aluminum sheeting acts as the grounding system and together with the aerial is tuned to a wave-length of about 150 meters. This wave-length is used because at present it is free from interference caused by other transmitting stations. In order to have the control system practical, it must be sharply tuned to eliminate the possibility of disturbing signals.

The receiving set used in this car is diagrammatically shown in Fig. 4. In the circuit shown, a vario-coupler is incorporated to increase the sharpness of the tuning. The remainder of the circuit, with the exception of the relay circuit, is the ordinary detector and two-stage amplifier. The large amount of amplification is necessary on distant signals; less would no doubt do for demonstration purposes in the laboratory. However, the purpose of this work was to produce a practical radio control system the effectiveness of which would not be limited to short distances; thus the complicated apparatus was installed.

This work was submitted by Mr. Engstrom to the faculty of the Polytechnic Institute of Brooklyn in partial fulfillment of the work required for the degree of Electrical Engineer.

A Complete Radio Library at Amateur Price

(Continued from page 694)

behavior of electro-magnetic waves in terms of precise measurements, this book cannot be appraised by its cost mark.

"Elementary Electricity," the title of a 23-page pamphlet issued by the Signal Corps of the War Department, is the "ABC" of the subject treated. This vest-pocket pamphlet, with a blue paper cover, concisely and clearly outlines the theory of magnetism and electricity, describes primary and storage batteries, and indicates their workable connections. A page of diagrams elucidates the contacts of batteries. Electro-magnetism mechanical generation of electricity, characteristics of direct currents, characteristics of alternating currents, and measuring instruments, are the other titled sub-divisions in this compact treatise. For a mere song—the price of a milk shake at a soda fountain—the novice can obtain a copy of this pamphlet on the ABC's of electricity.

"Primary Batteries," is a 66-page treatise of interest to novices and amateurs in the radio game, recently issued by the Signal Corps of the War Department. From the simplest explanation of a battery-apparatus for the conversion of chemical energy into electricity energy—to mathematical formulas of measuring the electrical power which a cell is capable of supplying an electric circuit, this publication, designated as "Training Pamphlet No. 7," is fairly exhaustive of the subject treated. If you want to have a "speaking acquaintance" with the source of energy which makes operative your radio telephone receiving set, then send ten cents

TUSKA RADIO



Tuska Popular No. 225

3-bulb Regenerative Receiving Set. Piano finish mahogany cabinet. Amplifier switch. Concealed binding posts. Armstrong circuit, licensed under Patent No. 1,113,149. Price \$75, without bulbs, batteries or loud speaker.

Ask for special circular No. 11-F, describing this set.

*Your
entertainers
are ready*



SINGERS, bands, orchestras, speakers, organists, humorists—an unlimited host of performers are yours to command when you own a Tuska Radio. A simple adjustment of dials, and you can choose between them. Dozens of programs are in the air. Your Tuska will bring in whichever entertainer pleases you best and shut out all others.

Tuska owners are not obliged to tinker incessantly and add devices to correct construction faults. Their pleasure is unmarred by troubles. Every Tuska set is finished with exacting care by painstaking New England workmen—the best that live. Then it is examined and tested on

distant signals by inspectors who are keenly critical. Both manufacturing and testing are under the personal direction of C. D. Tuska, a pioneer radio engineer.

For a dozen years before general radio broadcasting began, Tuska-made instruments were famous among radio experimenters for skillful design, superb workmanship and high efficiency. In the past two years the demand for Tuska Radio has grown enormously. Each set in this increased production of to-day is as perfectly built as the finest Tuska instrument ever made—and yet, the prices are remarkably moderate for high-grade radio receivers.

Ask any first-class radio store to show you one of the models of Tuska Radio, priced \$35 upward.

THE C. D. TUSKA CO., Hartford, Conn.

Ogden, Utah, receives Troy, N. Y.

"In one evening, using Tuska 225 with one amplifier only, I received 19 stations, including San Francisco; Calgary, Alberta; and Troy, N. Y. Conditions were not abnormal, and the same stations were received again last night.

W. D. GARNER."



Picks up Davenport the first time he tunes

"I never had my hands on a set until my Tuska came Saturday. First evening, I tuned in Pittsburgh, New York, Richmond, Ind., and Davenport, Iowa. It certainly was great.

WM. PARSONS, Salisbury, Conn."

New Thrills from Radio



ALL-AMERICAN Amplifying Transformers

Out-Distance and Out-Class All Your Radio Associates

"All-American" Transformers will enable you to annihilate distance, defeat interference, and abolish extraneous noises. They faithfully amplify the tone-quality of both distance and nearby broadcasting stations with remarkable volume. "All-American" Transformers mean thrills and radio achievements worth talking about.

Equally adapted for use with new and old circuits and all tubes. Approved and officially adopted by leading makers of high class receiving sets. Standard in the industry.

Ask your dealer to supply you with "All-American" Transformers. Every instrument guaranteed to be electrically and mechanically perfect.

FREE

"All-American" Book of Tested Hook-ups.
Send 2 cent stamp for postage and give
dealer's name and address.

RAULAND MFG. Co.
200 No. Jefferson St., Chicago, Ill.

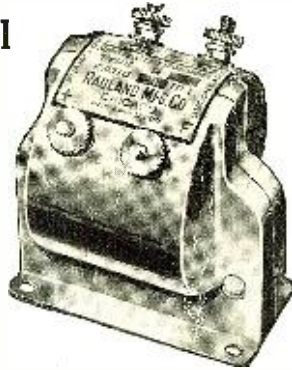

Audio Frequency
Transformer



Radio Frequency
Transformer

TO THE RADIO DEALER.

Let us explain how you can make the sale of our publications a worth while, well paying part of your business. Every one that enters your store is a prospective buyer of RADIO NEWS. RADIO NEWS will sell with little effort on your part.

You may sell our publications on a single copy basis with a fine margin of profit or on a subscription basis with a generous commission allowance.

Write now and prepare for the Fall and Winter trade.

EXPERIMENTER PUBLISHING CO.,
53 Park Place, New York.

to the Government Printing Office, Washington, D.C., for a copy of Training Pamphlet No. 7.

"How to build your own," to paraphrase the slogan of a particular brand of smoking tobacco, may be used to characterize a series of pamphlets issued by the Radio Laboratory of the Bureau of Standards. By titles, these circulars are: "Construction and Operation of a Simple Home-Made Radio-Receiving Outfit;" "Construction and Operation of a Two-Circuit Radio-Receiving Equipment with Crystal Detector;" and "Description and Operation of Electron-Tube Detector Unit for Simple Radio-Receiving Outfits." These papers, issued at a time when radio telephone broadcasting was at the crest of its popularity, received unprecedented recognition and the instructions contained within their covers have been serviceably applied throughout the United States. This series of pamphlets on how to build three types of wireless receiving sets was issued primarily for distribution by the United States Department of Agriculture to rural dwellers desiring to receive weather, market and crop reports. However, city dwellers and farmers alike have utilized the information contained in these circulars, copies of which may now be purchased at prices of five cents each for two of them and ten cents for the third pamphlet of the series.

When the electric-lighting wires are being tapped with increasing frequency as a source of energy for the operation of radio-telephone receiving outfits, the development of an electron-tube amplifier using ordinary 110-volt alternating-current lighting mains as a source of power for the filament and plate, is a subject of timely interest. This type of amplifier, which does not require the use of batteries, is adequately described, by text and illustrations, in Scientific Paper No. 450 of the Bureau of Standards. A copy of this pamphlet may be obtained by sending five cents to the Government Printing Office, Washington, D.C.

Radio-frequency amplification—to the extent of three and even four stages—is a subject of increasing importance in the reception of wireless communications. Hence, the Radio Laboratory of the Bureau of Standards has given circulation to a pamphlet entitled "Radio-Frequency Amplifiers," which outlines the three methods of coupling the output of one electron-tube into the input of another, thus affording a multi-stage amplifier of radio frequencies. These ways are, resistance coupling, tuned-plate coupling, and transformer coupling. A written request to the Government Printing Office for Scientific Paper No. 499, enclosing five cents, will bring a copy of this pamphlet.

"Wavemeters and Decremeters"—the latter a special design of wavemeter—is the title of a 58-page pamphlet issued by the Signal Corps of the War Department. The structural features of a wavemeter, directions for using this instrument at transmitters and receivers, how to use a wavemeter for measuring inductance or capacity, a description of special types of wavemeters, and a description of types of decremeters, are among the outlines contained in this paper. Upon application, requesting Radio Communication Pamphlet No. 28, ten cents will purchase a copy of this treatise.

A publication, bearing the title "Antenna Systems" and issued by the Signal Corps of the War Department, once considered "Confidential," is now released for circulation through the Government Printing Office, for a dime. Various types of antennae, distributed constants of an antenna, natural wave-length of an antenna, directional effect of an antenna, ground and counterpoise systems, and the methods of changing the wave-length, are among the topics briefly reviewed in the course of 20 vest-pocket size pages. Also a table of antenna constants is included in this treatise.

Build your own set with Gilfillan parts

THE work is interesting, instructive and not difficult. Then too, the finished set will give you splendid results—at low cost—especially if you have assembled it with *Gilfillan* standard high-quality parts.

Gilfillan Radio Parts are the perfect combination of scientific design, accurate workmanship and best materials; so when you select "*Gilfillan*" you're certain of the inbuilt dependability of that part.

If your dealer does not handle this superior line, write us for name of nearest dealer, descriptive folder and list.

Genuine Gilfillan Radio Parts can always be identified by this trade-mark. Look for it.



GILFILLAN BROS., INC.

1925 McGee St.,
Kansas City, Mo.

1815 W. 16th St.,
Los Angeles, Cal.

225 W. 57th St.,
New York, N. Y.

Licenses General Bakelite Co.

Two New Gilfillan Radio Parts



**PRIMARY INDUCTANCE
SWITCH**

15 point. Each point provided with positive stop, making rotating contact arm rest on center of point. Gives perfect contact. Moulded brown bakelite; black knob and dial.

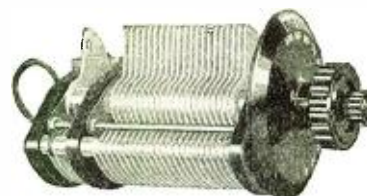

CONDENSER

With Vernier and pigtail connection. Obtainable in 43 plate, as above, and 23 plate sizes.

Other Gilfillan Parts

Varicouplers (2 sizes)	Tube Sockets
Variometers (2 sizes)	Tube Socket Adapters
Air Condensers (3 sizes)	Detector Amplifier Units
Audio Frequency Transformers	Detector Units
Potentiometers	Vernier Air Condensers
Primary Inductance Switches	Filament Rheostats
Panel Switches	Vernier Rheostats
	Moulded Knobs, etc.

**"A Little Well Built,
is better than a Lot Poorly Built"**

Build Right by using

Walnart Quality Radio Products

Every part that goes into a radio set should be the best obtainable. Better build a small single tube set of quality products, than try to build a bigger set, of poor parts.

Walnart's products have been on the market for years. Seldom do we have a part returned. In thousands of sets Walnart parts are giving 100% service day after day, year after year. We do not know of any greater recommendation for you than this.

We also manufacture Variable Grid Resistance and tube sockets. Complete catalog on request.



**Walnart
Inductance Switch**
10 Contacts in 1
\$1.00

Ask your dealer to show you these Walnart quality parts; if he can't supply, write us.



**Walnart
Variable Condensers**
Plain and Vernier

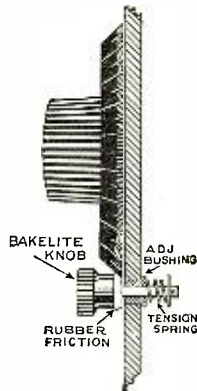

**Walnart
Vernier Adjuster**
The biggest little thing
in Radio
25c

WALNART ELECTRIC MFG. CO.

Dept. 604, 1249 W. Van Buren Street
Chicago, Ill.

Radio Communication Pamphlets Nos. 14, 11, 25, 27, 17, and 26 are detailed descriptions of various radio telephone and telegraph outfits in use by the Signal Corps of the War Department. Radio Communication Pamphlets Nos. 13, 20 and 30, are technical descriptions of apparatus used on board aircraft for communication purposes. "The Radio Mechanic and the Airplane," is the subject of a sketch outlining for the benefit of the radio mechanic the features of an airplane, thus enabling him to install wireless apparatus on aircraft. The purchase price of any one of these radio publications does not exceed fifteen cents, and in most instances a single copy may be had for five cents.

The nature of many of the radio publications obtainable from the Government Printing Office, Washington, D.C., is suggested by their respective titles, namely, "Antenna Radio Stations of the United States," "Amplifiers and Heterodynes," "Antenna Resistance," "Commercial and Government Radio Stations of the United States," "Commercial Traffic Regulations," "Elementary Principles of Radio Telegraphy and Telephony," "Ground Radio Telephone Sets," "High-Frequency Ammeters," "Measurement of Electrical Oscillations in Receiving Antenna," "Note of Resistance of Radio-Telegraphic Antennae," "Operation of the Modulator Tube in Radio Telephone Sets," "Principles of Radio Transmission and Reception with Antenna and Coil Aerials," "Radio Communication Laws of United States and the International Radio-Telegraphic Convention, Regulations Governing Radio Operators, and the Use of Radio Apparatus on Ships and on Land," "Radio Compass Bearings," "Radio Direction Finder, and Its Application to Navigation," "Sources of Elementary Radio Information," and "Visual Signaling, Lamp, Fireworks and Panel Liaisons Analyzed as to When, Where, and How Used."

With the exception of the book entitled "Commercial Traffic Regulations," which is obtainable at a purchase price of \$1.00, the price of any copy of the 18 radio publications named in the preceding paragraph does not exceed fifteen cents. The 38 publications—all of which may be obtained for a lump sum of \$5.85—are listed, together with their numbers and purchase prices on a sheet of paper, labeled "Important Radio Publications." A copy of this price list may be had, free of charge, upon application to the Government Printing Office. Or, any copy of the pamphlets referred to in this article is purchaseable at the specified price, by applying in writing or in person to the Superintendent of Documents, Government Printing Office, Washington, D.C.

Additional to the list "Important Radio Publications," which is subject to change, the Radio Laboratory of the Bureau of Standards names the following publications of interest to the wireless fraternity: "Formulas and Tables for the Calculation of Mutual and Self Inductance," "Insulating Properties of Solid Dielectrics," "A Direct Reading Instrument for Measuring the Logarithmic Decrement and Wave-Length of Electro-magnetic Waves," "Effect of Imperfect Dielectrics in the Field of a Radio-Telegraphic Antenna," "Additions to the Formulas for the Calculation of Mutual and Self Inductance," "Electrical Oscillations in Antennae and Inductance Coils," "Airplane Antenna Constants," "Dependence of the Input Impedance of a Three-Electrode Vacuum Tube Upon the Load in the Plate Circuit," "Variation in Direction of Propagation of Long Electro-magnetic Waves," "Determination of the Output Characteristics of an Electron-Tube Transmitter of Completely Modulated Waves," "Some Effects of the Distributed Capacity Between Inductance Coils and the Ground," "The

JUST THE BOOK YOU WANTED

"Radio News" Amateurs' Handibook

Volume No. 1

Check full of radio constructive and instructive articles from cover to cover. Written by foremost radio authorities, in plain everyday language which everyone can understand. Sections include articles on Receiving Sets and Sundry Apparatus, Transmitters and Accessories, Radio Theory, Vacuum Tube Data, and Practical Hints for the Amateur. A book which also serves as a ready reference and should find a place in the library of every amateur. It contains 224 pages and over 375 illustrations, diagrams, and photographs, bound in a multi-colored heavy board.

On sale at all leading radio stores. If your dealer cannot supply you, pin a dollar bill to this ad and write your name and address in the margin below, and book will be forwarded to you postpaid.

EXPERIMENTER PUBLISHING CO., INC.
53 PARK PLACE, NEW YORK

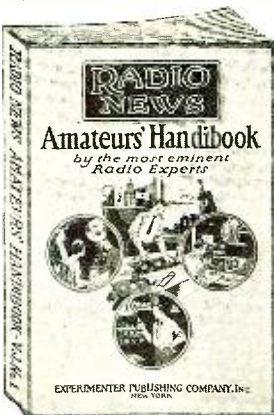

PRICE, \$1.00

SUPER-HETERODYNE

The World's Best Radio Receiver

BY PERFORMANCE

ADVANTAGES NO OTHER RECEIVER CAN EQUAL

- 1. UNIFORM EFFICIENCY** over the entire wavelength range of 160 to 850 meters. This means that all stations, Radio-Phone Broadcasting, Amateur and Commercial within this wavelength range, will be received with maximum intensity. This very desirable feature is not obtainable by any other practical method using Radio Frequency amplification.
- 2. SELECTIVITY** by this system, greatly exceeds that obtained in all other methods of reception. Using the Model "C" with a loop in the Suburbs of New York, WOR 15 miles distance, operating on 405 meters, can be completely eliminated, and PWX 1300 miles distance operating on 400, can be received on a loud speaker. This holds true on an average cool night. There is no telegraphic interference from 200 meter amateur stations or 600 meter ship stations.
- 3. SIMPLICITY** to change from one station to another, there are only two dials to vary. The two dials can be calibrated for all the various stations, as there is only one best position for each station.
- 4. AMPLIFICATION** is much greater than obtainable in any other standard receiver. Total is as follows: 1st the Heterodyne Amplification in the 1st Detector; 2nd, the Regenerative Amplification in the 1st Detector; 3rd the 3 stages of Tuned Regenerative Radio Frequency Amplification; working at a low advantageous frequency; 4th, the second Detector action, and 5th, the two stages of low ratio distortionless audio frequency amplification.
- 5. RECEIVING RANGE** other factors correct, the receiving range is in proportion to the effective radio frequency amplification applied. As this receiver has much greater effective radio frequency amplification than all others, the range is proportionally greater.

Complete Constructional Blue Prints Consisting of Two Sheets 50x21" and Two Sheets 27x21" and Two Sheets 30141-145. \$2.00 Postpaid.

Designers of the Highest Class Radio Apparatus in the World
Experimenters Information Service 531 West 46th Street :: New York City

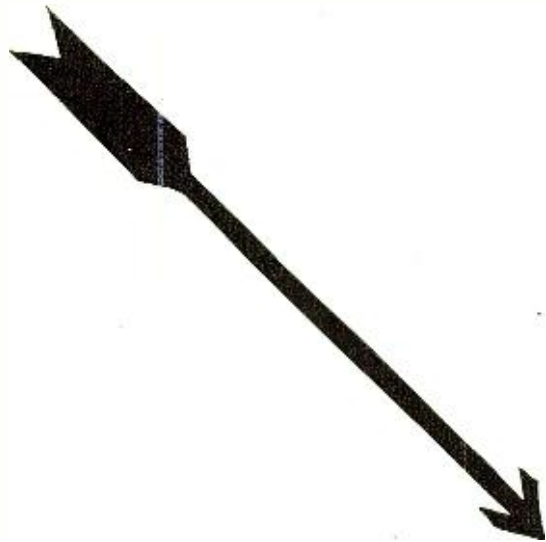

"THE ROLLS-ROYCE OF RECEPTION"

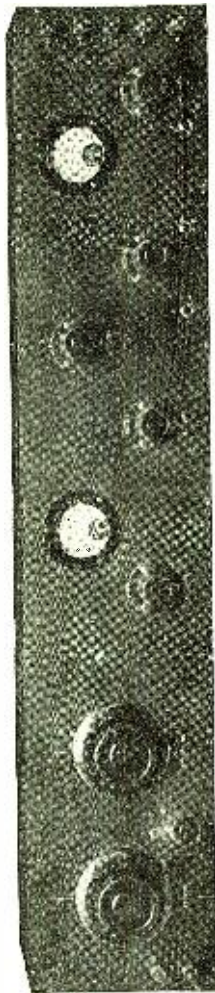

MODEL "C" SUPER-HETERODYNE

Wavelength Range 160 to 850 meters. Tubes, 2 Detectors, Oscillator, 3 Tuned Radio Freq. Amplifiers, 2 Audio Amplifiers.

The Super-Heterodyne is the most efficient method of short wave radio frequency amplification known. It is used extensively by the Commercial radio companies and various governments, when it is necessary to receive over extremely long distances, without interference from near-by stations. The remarkable results are due to the Super-Heterodyne action, which is briefly as follows: the incoming signal, which may be any wave from 160 to 850, is changed thru the use of a local oscillator, to a wavelength of 10,000 meters. At this wavelength an exact duplicate of the original signal is amplified at radio frequency with the very highest efficiency possible, rectified and amplified at audio frequency.

During this change a very high degree of selectivity is secured, due to the amplifier, which is designed to pass nothing but 10,000 meters. Accordingly while there may be ten or more signals in the loop, only one will be received at a time, the one that the oscillator heterodynes thru the amplifier.

POPULAR PACENT PRODUCTS

PACENT Products are popular with the man who sells them because they are popular with the man who uses them. This popularity is based on "making good." Every PACENT Product has made good since its introduction.



PACENT COIL MOUNTING EQUIPMENT—The genuine Duo Lateral Coil, Pacent, has been recognized by authorities as the most efficient. As auxiliary to the Duo Lateral Coil

there is now available a complete line of improved coil equipment including Coil Plug, Rectentacle, Micromount (three coil mounting), and other items, all incorporating many advanced features.



NO. 100 PACENT DUO PLUG—Price \$1.00. This is a quality plug made for the most exacting radio users. It accommodates two pairs of phones. Incorporates special toggle connector features. All parts finest materials and precisely made.



NO. 85 PACENT RHEOSTAT—Price \$1.00. Supplied in resistances of 6, 10, 20, 30 and 50 ohms. Simple to install. Trouble-proof. Silvered dial with each Rheostat.



NO. 80 PACENT SOCKET.—Price \$.50 for U.V.-199 tubes. High-grade insulations. Phosphor bronze springs. Special hexagon connection posts.



NO. 20 PACENT ADAPTER—Price \$.50 for U.V.-199 and C-299 Tubes. The various requirements of an adapter are ideally combined in this product. Will work efficiently in radio frequency circuits. Makes perfect contact. Phosphor bronze springs will not short circuit.

"Don't Improvise - - Pacentize"

Send for bulletins N-12, describing in more detail above and other Pacent Essentials.

Pacents Electric Co., Inc.

22 Park Place, New York.

Sales Offices: Chicago, Philadelphia, St. Louis, Minneapolis, Washington, D. C., San Francisco, Jacksonville.

Pacents

RADIO ESSENTIALS

14 RADIO FORMULAE AND DIAGRAMS FOR 50c.

PARTIAL CONTENTS



Measurement of Capacity of a Condenser. Measurement of Inductance of a Coil or Circuit. Two Methods—Two Diagrams. Measurement of Distributed Capacity of an Inductance. Diagram and Curve. Measurement of Fundamental Wavelength of an Antenna. Three Methods. Three Diagrams. Measurement of Wavelength of Distance Transmitting Station. Two Methods. Calibration of a Receiving Set. Two Diagrams. Measurement of Effective Antenna Capacity. Two Methods. Two Diagrams. Measurement of Inductance of Antenna and a Third Method of Measuring Effective Capacity of Antenna. Measurement of Antenna Resistance. Substitution Method.

With this packet of radio knowledge you need never worry about schematic wiring diagrams, measurements and radio tables. All formulas and diagrams are printed on heavy paper in black and blue; and contained in two-color printed envelope, 9x12 in.

FOR SALE AT ALL DEALERS

THE CONSRAD COMPANY, INC.

233 Fulton Street

New York City

High-Frequency Resistance of Inductance Coils," and "The Field Radiated from Two Horizontal Coils."

These publications, too, are purchasable from the Government Printing Office at prices ranging from five to twenty cents. The products of Uncle Sam's use of printer's ink, of course, are cumulative, the list of publications on radio telephony and telegraphy being constantly expanded. The popularity of wireless broadcasting and the heightened public interest in this subject have increased the volume of output, if they have not quickened the pace, of the Government printer. For instance, only recently the Radio Laboratory of the Bureau of Standards has brought forth a publication giving the results of significant experiments in the experimental use of 10-meter wave-lengths, or 30,000 kilocycles, for radio communication purposes.

C. W. and Radiophone Transmitters

(Continued from page 705)

out the undesired alternating ripples and retain the D.C. voltage. Some filters weed out some of the A.C. ripples only, the efficiency depending upon the constants of the filter circuit. One of the simplest, yet most effective filter circuits is given in Figs. 2 and 3. It consists of condensers C1 and C2, each of which should be between 2 and 4 microfarads each, the higher the better, and a choke coil of at least 20 henries or higher. This choke coil may be connected either as one unit, as in Fig. 2, or as two units, as in Fig. 3. In order to obtain such high inductances it is necessary to employ iron cores and the best design for such iron cored inductances has been given by Prof. F. S. Dellenbaugh in the August issue of "QST," in which designs for inductances up to 100 henries was given. The constructor would do well to follow these designs as they are the result of considerable experimentation at the Massachusetts Institute of Technology. The condensers must be able to withstand the high plate voltages which are used on the tubes, and hence should be of the mica dielectric type, such as made by reliable manufacturers.

Electrolytic rectifiers may also be used, but they require constant attention and are rather bulky; data for the construction of such rectifiers was given in RADIO NEWS and other publications.

RADIO FREQUENCY CIRCUIT

The most suitable circuit should give the best results with a minimum of apparatus. Although there are a number of circuits which will give excellent results, many of them require considerable equipment. The so-called Hartley circuit in either the series or shunt feed arrangement is a very suitable circuit and the connections are shown in Fig. 4, detailed description of which is given in the following: Fig. 4 illustrates the series feed arrangement, while Fig. 5 illustrates the shunt feed arrangement. The only difference between these two methods of connection is that, since in the shunt feed circuit the plate supply is in parallel with the output circuit of the tube there is a short circuiting effect taking place on the output circuit by the plate supply, and to avoid this it is necessary to place a radio frequency choke coil R in series with the positive D.C. plate lead, which prevents any radio frequency from backing into the D.C. supply and hence prevents this short circuiting effect. The circuit requires, therefore, the following apparatus: A variable inductance coil L, a grid condenser Cg, a grid

Hear What You Like— Hear It Clearly and Well—



GOLDCREST
Model 42
\$135.00

This is a beautiful solid mahogany console unit completely self-contained and is equipped for a loud speaker behind the grill. It can be used as a table in your living room.

The Model 42 is a four tube receiver employing a reflex circuit to be used with either loop or outdoor antenna. It functions as a six tube receiver with three stages of radio frequency amplification and has a battery switch control. A jack is placed after the first stage of audio frequency amplification for head phone use. This instrument operates with 1½ or 6 volt tubes.

All of our three and four tube instruments can be inserted in this console.

Every program within the long range of CLEARSTONE Receivers furnishes real entertainment with no annoying indistinctness despite heavy static.

The astounding tone clarity is matched by volume, sensitiveness and simplicity of control in

Clearstone Receiving Sets

Every instrument is designed and completely manufactured in our own plant, directly from the raw materials.

These facts enable us to absolutely guarantee construction, efficient operation and satisfaction to every purchaser. All CLEARSTONE Radio products combine distinctive appearance with simplicity and ease of operation.

MR. JOBBER: Send for our interesting proposition and discounts.

MR. DEALER: Send for our literature and mention your nearest jobber's name.

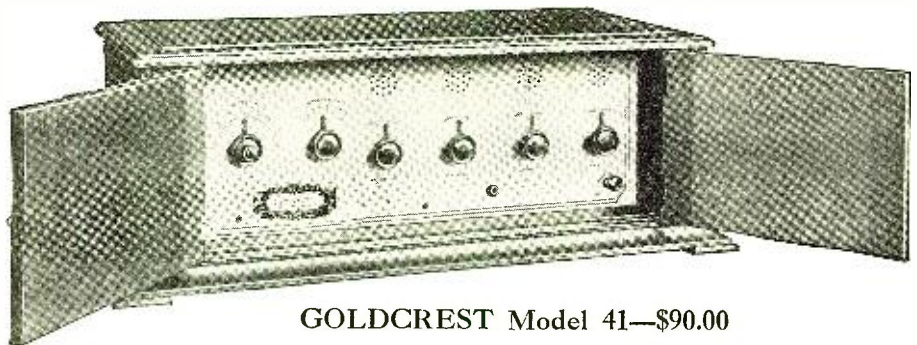

GOLDCREST Model 41—\$90.00

The GOLDCREST Model 41 is a four tube instrument which has three stages of radio frequency amplification, a detector and two stages of audio frequency amplification. This unit functions on a loop or outdoor antenna.

The beautiful and distinctive solid mahogany cabinet with the engraved gold paneled instrument makes a completely self contained unit when 1½ volt tubes are used.

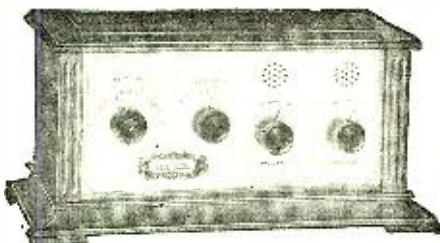

GOLDCREST Model 20—\$40.00

Unusual clarity of tone and remarkable volume. All types of tubes can be used in this model. The unit functions as three tube receiver with one stage each of radio and audio frequency amplification. The handsome solid mahogany cabinet and engraved gold panels with black lettering presents a beautiful contrast of colors that compels admiration.



CLEARSTONE Model 60—\$60.00

This remarkable instrument in the past year has made many friends because of its wonderful performance, distinctive appearance and unusual simplicity of operation.

In a competitive test at the St. Paul Dispatch Laboratory, Model 60 won first place as the best of thirty standard makes of instruments.

Model 30— \$55.00
Model 31— \$70.00

Model 32—\$115.00
Model 40— \$75.00

Model 61— \$75.00
Model 62—\$120.00

Write us for folders on complete line

The Clearstone Radio Company

Cincinnati, Ohio

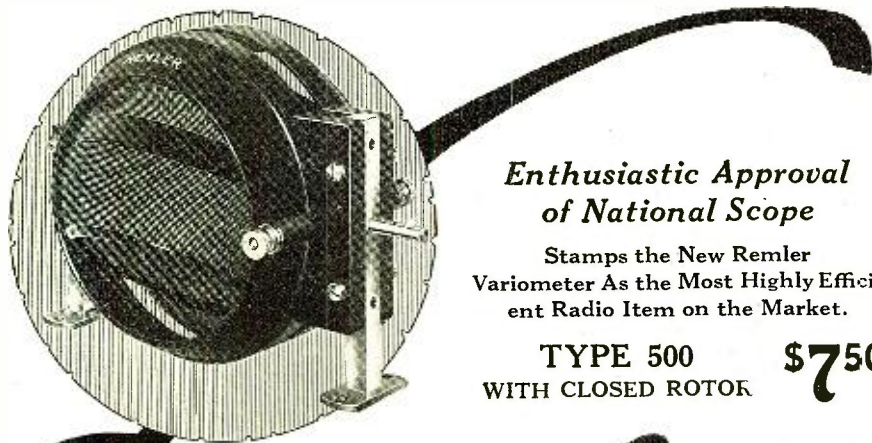

**Enthusiastic Approval
of National Scope**

**Stamps the New Remler
Variometer As the Most Highly Efficient
Radio Item on the Market.**

**TYPE 500 \$750
WITH CLOSED ROTOR**

Remler VARIOMETER:

**With Internal Pigtail Connections
Wave Length Range 180 to 570 Meters Positively Guaranteed**

Seldom, if ever, has there been more genuine enthusiasm shown over any radio apparatus as has been demonstrated by everyone who has examined and placed in operation this new and improved Remler Variometer.

Its low minimum and high maximum wave length—the *greatest ever obtained in a variometer* and the wave length variation is exactly proportional to the reading of the dial scale. When used with any variocoupler it will cover the entire range of amateur and broadcast wave length. A wave length range of 180 to at least 570 meters is guaranteed when used with a Remler vario-coupler. Pigtailed connections are used between stator and rotor resulting in perfect contact and quiet operation. All metal parts are buffed and nicked; green silk wire is used on both stator and rotor. The general appearance and quality of the bakelite molding is the best obtainable, making it a leader in appearance as well as performance.

If your dealer cannot supply you, send the attached coupon direct to us with express or postal money order. Write for complete descriptive circular.

Remler Radio Mfg. Co.,
182 Second St., San Francisco, Calif.

Gentlemen:—Please send me by return parcel post one new and improved Remler Variometer Type 500 for which I enclose Seven dollars and fifty cents (\$7.50). If for any reason whatsoever I am not satisfied with this Variometer, I can return it to you express collect and you will refund my seven dollars and fifty cents in full.

Name

Address

Remler Radio Mfg. Co.

Home Office:

182 Second St., San Francisco

154 West Lake Street,
Chicago

30 Church Street,
New York City

leak Rg, and possibly an antenna series condenser Ca. In the case of the shunt circuit there is required further the radio frequency choke coil R.

ANTENNA INDUCTANCE

The antenna current carried by the coil in a set of the order of 50 watts to 200 watts is fairly high, and unless the coil is designed for low resistance the losses will be considerable, thus reducing the efficiency of the set. For this coil it is therefore best to use coils wound with copper strip whose losses and resistance are low. Some oscillation coils now on the market are ideal for this purpose as they are especially designed for just such circuits as the one here described and have the proper winding for it. Furthermore, it is very easy to make adjustments and alter taps on such coils. Any helix about 6" or 7" in diameter with about 30 to 40 turns of copper strip or copper tubing will do very well. Heavy Litz cable will likewise do, provided there is enough surface to dissipate the heat which may develop by the heavy current. The use of a copper strip wound coil has the important added advantage of being practically an air core coil, with no solid dielectric, and hence dielectric losses and distributed capacity are a minimum.

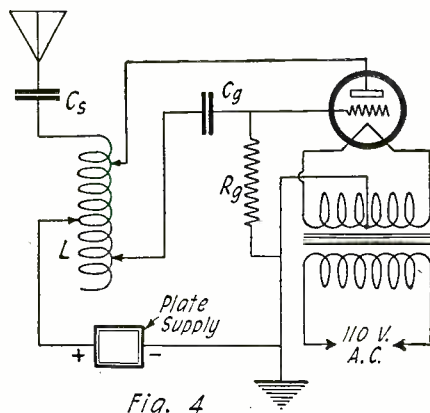

Fig. 4

The Hartley Transmitter Circuit Employing the Series Feed Arrangement.

The grid condenser Cg should have a capacity of 0.002 microfarad. This should be a mica condenser. The grid leak Rg should be a resistance of 5,000 ohms, wire wound resistances being best. Carbon or similar resistances are absolutely unsatisfactory for this purpose as the magnitude of current is sufficient to heat and alter its resistance too much. The use of an antenna series condenser Cs is frequently necessary in order to enable reaching the low watts required for amateur transmission. This should also be a mica condenser, the capacity being about 0.0005 microfarad. The use of a series condenser is to be recommended for getting down to the fundamental wave-length of the antenna. It is a well known fact that the radiation resistance of an antenna is a maximum at the fundamental wave-length of the antenna. It is generally impossible to reach this wave-length on account of loading it up with inductance, and to get down to the fundamental, therefore, requires the use of a series antenna condenser.

Where the shunt feed circuit is used, as in Fig. 5, two additional pieces of apparatus are required: a radio frequency choke coil R and a plate stopping condenser Cp. The object of the radio frequency choke is to prevent the plate supply from short circuiting the radio frequency circuit since they are both in parallel with the tube. A coil satisfactory for this purpose should have a very high impedance to the currents of the frequency of the R.F. circuit. Such a coil would be one whose distributed capacity and inductance gave it a natural period equal to that of the R.F. oscillations, for then the

THE CRYSTAL THAT MADE GOOD OVER NIGHT

Just 4 months ago Anchorite was an unknown crystal—today Anchorite is being shipped in nearly every state in the Union and Canada.

THERE'S A REASON

Anchorite is the best crystal in America for crystal sets—for reflex circuits and for any other radio work where a 100 percent crystal is necessary. It is the only crystal in the world that will pick up outside stations on a crystal set distinctly without distortion and static noises.

ANCHORITE SELLS FOR 25c.

And there is no crystal sold at even 4 times the price that is its equal.

OUR IRON CLAD GUARANTEE—Anchorite is sold to you on a money back guarantee—if it does not do everything we say—return the crystal and your money will be refunded.

Address All Correspondence to
THE ANCHOR CO.

Send 25c in silver and a crystal will be sent you postpaid. 420 Wood St. Pittsburgh, Pa. DEALERS Write for exclusive sale rights.

Insure your copy reaching you each month. Subscribe to Radio News—\$2.50 a year. Experimenter Publishing Co., 53 Park Place, N. Y. C.

Radio Catalogue Free—

**Write us
a post card—
Address Dept. 2-R**

and we will send you free this 52 page catalogue of radio sets and parts. It also contains explanation of radio terms, map and list of broadcasting stations and much radio information, including an explanation of successful hook-ups and circuits.

You will be amazed at the low prices Ward's quote. A complete tube set having a range of 500 miles and more, including tubes, head set, batteries, and antenna equipment, as low as \$23.50.

This catalogue contains everything for the expert and amateur. Complete sets and every improved part for building sets, all the most up-to-date devices—at the lowest possible prices.

Headquarters for Radio

Montgomery Ward & Co. is headquarters for Radio, selling everything direct by mail without the usual "Radio-profits." Why pay higher prices? Ward quality is the best and the prices will often save you one-third. Everything sold under our Fifty Year Old Guarantee,—Your Money Back if You Are Not Satisfied. Write today for your copy of this complete 52-page Radio Book.

Write to our house nearest you. Address Dept. 2-R
Chicago Kansas City St. Paul Portland, Ore. Ft. Worth

Montgomery Ward & Co.

The Oldest Mail Order House is Today the Most Progressive



Use KESTER self fluxing WIRE SOLDER



Kester Solder is simple, safe and sure, because it supplies its own flux from tiny pockets inside the hollow wire of virgin tin and lead solder. (See phantom view below.)

As the heat is applied and just before the solder melts, these pockets open—one at a time—and the scientifically prepared flux flows only where it is needed, thus assuring a neat and substantial job in a rapid and economical manner.

Solder connections in Radio work are better. Those who have had discouraging results with ordinary solder or have not attempted to solder can easily use this simple form. Pick up Kester Solder and any form of heat, and solder away, quickly, neatly and economically.

Phantom to the right shows why Kester Solder automatically fluxes.

For general soldering and heavier electrical and Radio work, use Kester Acid-Core Wire Solder. For delicate electrical and Radio soldering, use Kester Rosin-Core Wire Solder.

Sold in convenient sizes to meet every requirement.

"Requires Only Heat"



Manufacturers

CHICAGO SOLDER COMPANY
4245 Wrightwood Avenue, CHICAGO

Live Dealers in these lines sell KESTER Self-Fluxing Solder

Hardware
Automotive

RADIO

Electrical
Mill Supplies

If Your Local Dealer Cannot Supply You—Write Us Direct

TO THE RADIO DEALER.

Let us explain how you can make the sale of our publications a worth while, well paying part of your business. Every one that enters your store is a prospective buyer of RADIO NEWS. RADIO NEWS will sell with little effort on your part.

You may sell our publications on a single copy basis with a fine margin of profit or on a subscription basis with a generous commission allowance.

Write now and prepare for the Fall and Winter trade.

EXPERIMENTER PUBLISHING CO.,
53 Park Place,
New York.

coil would have a maximum impedance at that frequency and prevent any R.F. current from flowing through the plate supply. It is difficult to get just such a coil. However, for work around 200 and 300 meters a coil having an inductance of about 2 to 3 millihenries will generally be found to be satisfactory, and it is suggested that different values of inductance be tried in this range until the best value is found, which will be when the maximum output is secured with the minimum input to the plate. If choking action is poor, the plate input goes up and efficiency decreases. A good form of radio frequency choke is a square

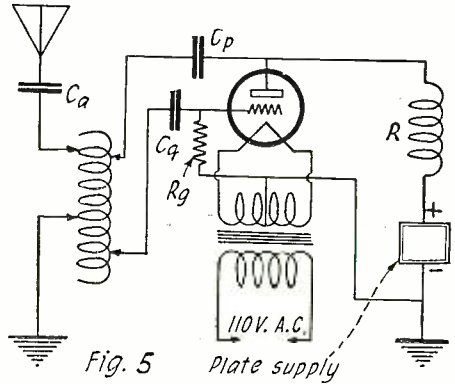

Fig. 5 The Hartley Circuit With a Shunt Plate Supply.

section coil, similar to the honeycomb type. Such a coil may easily be wound in accordance with the specifications of Fig. 6. The form may be wood having an inside diameter of about 1" to 1½", wound as indicated with between 150 and 200 turns. It would be a good idea to wind 250 total turns and take out taps between 150 and 250 turns at intervals of about 25 turns. This would permit adjusting the choke to the best value.

The object of the plate condenser Cp is to prevent short circuiting the generator supply to ground through the inductance coil L. This condenser must satisfy one important condition. It must have a very low reactance to radio frequency currents so that they may be by-passed with small drop in voltage. At the same time they must be able to withstand the total plate voltage. Hence they should be mica condensers specified by the makers to withstand this voltage. In order that they by-pass the radio frequency currents they should have a capacity of at least 0.001 microfarad, higher capacities being preferable when only telegraphy is employed.

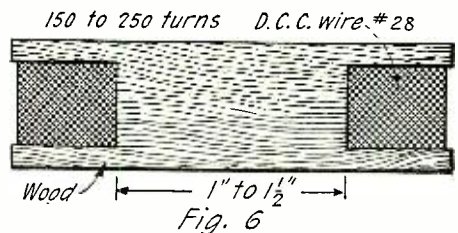

Fig. 6 Necessary Details for the Construction of a Radio Frequency Choke.

The tuning of the circuit is accomplished by means of the antenna and ground taps. However, maximum output at maximum efficiency is secured by adjusting the grid and plate taps. These taps vary the values of radio frequency voltage applied to plate and grid until the best ratio is found. At the same time adjusting the plate tap is equivalent to altering the ratio of transformation of the oscillation transformer between antenna and plate and thus help to adapt the tube to the antenna circuit, as explained in the last article of this series. All four taps should be adjusted and varied

Sensations of Modern Radio!

FRESHMAN PRODUCTS

Ever since Radio first became generally popular, Freshman Products have been universally recognized for their precision-like accuracy, mechanical perfection, scientific correctness and unusual durability. Freshman Products are used and endorsed by hundreds of thousands of radio experts and fans throughout the world.

Highest Quality Mica Condensers



Through the accuracy and dependability of Freshman Condensers, hook-ups and circuits have been perfected which have completely revolutionized the art of Radio Reception.

These little Storer's of energy and rectifiers of Radio Current are the very heart of a well-built radio set.

The proper fixed condensers will make all the difference in the world in the reception, clarity and selectivity your set affords.

Capacity	Each	Capacity	Each
.0001	\$.35	.0025	\$.50
.00015	.35	.003	.60
.00025	.35	.0035	.70
.0002	.35	.004	.75
.0003	.35	.005	.75
.00035	.35	.006	.75
.0005	.35	.007	1.00
.0006	.40	.008	1.00
.0008	.40	.01	1.00
.001	.40	.015	1.50
.0015	.40	.02	2.00
.002	.40	.025	2.50

The FRESHMAN is so designed that constant equal pressure is exerted on the condenser plates over the entire area. They are the only condensers that do this and therefore the only condensers that avoid noises, which are due to variable pressure on the plates.

All Freshman Products at your dealers—otherwise send purchase price and you will be supplied without further charge.

NEW TYPE Variable Resistance Leak

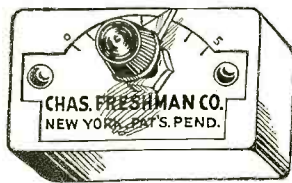

Only the Knob Shows on the Panel

This device is especially built for use as a tuning instrument. Its construction is such that it will withstand unusual usage. Fully guaranteed. *Absolutely no pencil markings.* Can be mounted on any panel in a few seconds. It will enable you to get stations you have never heard before.

Complete with either .00025 or .0005 Freshman Condenser ... **\$1.00**
Without Condenser **.75**

Troublesome Static Overcome



ANTENELLA NOW ONLY \$1.25

No Aerial or Antenna Needed

Eliminates aerial, outside wiring, lightning arresters, and other inconveniences inductive to static. Plug Antenella in any lighting socket and you can enjoy Radio in any room in your house. No current consumed.

Resistance Leaks

The Largest and Most Complete Line in the World



Every tube and every circuit requires a different leak resistance. You do not know what value is necessary until your circuit is tested. Freshman

Variable Resistances give an unbroken range of 180 degrees from 0 to 5 megohms. Absolutely no pencil markings.

Base Mounting Type with either **\$1.00**
.00025 or .0005 Freshman Cond.
Without Condenser **75c.**



FRESHMAN "FIX-O" FIXED RESISTANCE LEAK COMBINATION 4 IN ONE

Freshman Condenser .00025 }
Leak Mounting }
Freshman Resistance Leak }
Safe-T Handle }

Price Complete **65c.**



FRESHMAN FIXED RESISTANCE LEAK

with SAFE-T Handle

The only Resistance Leak using no carbon, graphite or lamp black. Guaranteed to remain permanently constant.

Furnished in any value of Resistance from 1/4 Megohm up **30c.**



FRESHMAN NOISELESS

TESTED MICA CONDENSER and LEAK MOUNTING

The Freshman Condenser is so designed that constant equal pressure is exerted over the entire area of the condenser plates and the mounting is part of the condenser itself, which makes this new product the only True and Perfect Leak Mounting on the market.

Combination Condenser .00025 and Leak Mounting **40c.**

Chas. Freshman Co. Inc.
Radio Condenser Products
106 Seventh Ave. New York

Ask your dealer or write direct for our FREE DIAGRAMS of the Neutrodyne, Flewelling and other circuits.

Save on All Radio Supplies!

Armstrong Regenerative Set

Licensed under the Armstrong Patent No. 1118149 for amateur experimental and scientific use only.



Order Direct From This Advertisement

Receiving Radius 600 Miles

\$23²⁵

FREE Radio Catalog! Send Coupon

A Wonderful Bargain!

HERE is a money saving Radio Outfit that will bring the news of the world—concerts, lectures and stock reports—into your home. Would ordinarily cost \$35.00 to \$40.00. Sold complete with head set, tube, batteries, aerial and ground wires, for only \$23.25! Connections simple and plainly marked. Easy to tune. Long receiving radius. Order NOW! Shipping weight, 12 pounds. Shipped from CHICAGO or PHILADELPHIA Store.

57RN9366.....\$23.25

Get New FREE Book!

Save money on your radio supplies, and get guaranteed quality! Our big FREE Book shows hundreds of bargains in complete sets and parts. Many new hookups, complete list of broadcasting stations. Contains "How to Build an Aerial." Invaluable to expert and amateur. MAILED FREE! Ask for Radio Catalog No. 82R64.

Sears, Roebuck and Co. Chicago - Philadelphia
THE LARGEST MAIL ORDER HOUSE IN THE WORLD

RADIO

Sears, Roebuck and Co. Philadelphia
Chicago - Philadelphia

Send me FREE Radio Book No. 82R64.

Name _____

P. O. _____ State _____

Rural Route _____

Street & No. _____ Box No. _____

alternately until the best adjustments are secured, and this is obtained when the maximum antenna current is secured with the least possible input. As in the low power set described in the last issue of RADIO NEWS, meters should be placed in various parts of the circuit to enable proper adjustments.

The same type of set and equipment is suitable for higher power sets up to 200 watts. With a 50-watt tube it is necessary to use only 1,000 volts maximum on the plates of the tubes, whereas when a 200-watt tube is employed, it will be necessary to go as high as 1,500 to 2,000 volts D.C.; this requires the suitable plate transformer for stepping up the A.C. voltage to these values before rectification. The constants of the R.F. circuit are practically the same.

When we come to the subject of radio telephony, certain modifications are necessary in design, and these will be our next considerations in the following articles.

Correspondence from Readers

(Continued from page 727)

non-oscillating stage where there is any great amount of interference.

As to the superiority of single circuit receivers over three-circuit receivers, he mentions the fact that he can hear Fort Worth and Havana regularly. I do the same, Mr. Brackenridge, with single circuit or with three circuit from my home in Portland, Oregon. I also can hear WJZ, KDKA, WOR, WDAP and other Eastern stations that are as good as your best distances. The intensity is about the same with either set. I live four miles from the region where the broadcasting sets are located and, WITH THE TRIPLE CIRCUIT I CAN HEAR THEM THROUGH THE LOCAL BROADCASTING.

I have had about eight years' experience with various circuits and have actually used each long enough to understand how to handle it. I recommend that Mr. Brackenridge use a triple circuit for about three months exclusively and then he will be in a position to judge their relative merits.

Come Mr. Brackenridge, confess: How much experience have you had with the various forms of the triple circuit?

Yours for the abolition of the re-radiating receiver.

GARRETT W. LEWIS,
70Z & KDZJ
Marysville, Cal.

REGARDING THE AMATEURS AND INTERFERENCE

Editor, RADIO NEWS:

After reading the correspondence from readers' section of your magazine I thought I would make bold enough to drop you a line. I am one of those much discussed (and cursed) BCL's, and own a six-tube set with a lot of knobs and silver dials. I have listened to the row between the amateurs and the BCL's for a long time and think that half of it is "bunk" and the other three-eighths is "sham." When I first bought my set I listened to the DX stations every night and once in a while a station would come butting in with a lot of code and spoil it all. Naturally I was sore. After reading all about the amateur interference question in the radio periodicals I thought it was some of the spark-coil hams pounding away. I made a lot of fuss and kick about it until I found out that it was a government station butting in on my concerts. I felt kind of small after the way I had talked about the amateurs. I now have had my set for a year and a half and I can honestly say that not once in all the time of my operating was I interrupted by

LEAD-IN INSULATOR

—Hard Rubber

Necessary in every antenna installation. Neat in appearance, permanent when once installed. The M & M Lead-in Insulator is the solution of the Lead-in problem. Weather-proof, water-proof, excellent insulation. 4 inch size for windows, 10 inch size for walls and casings.

Prices 4 in. 50c., 10 in. 80c. at your dealers.

Dealers. Your jobber stocks our insulator.

Jobbers. Write for our proposition.

The M. & M. Co.

500 Prospect Ave., Cleveland, Ohio

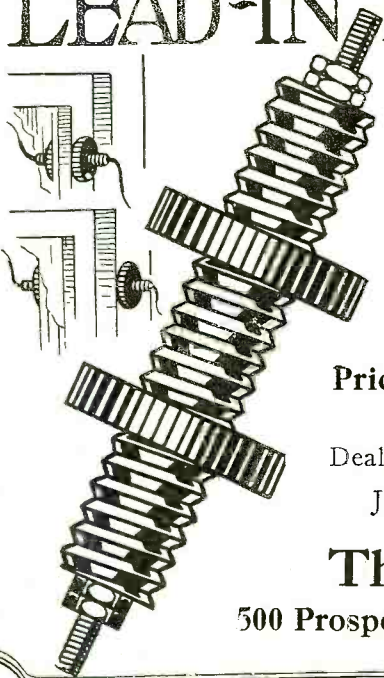

SUPREME!

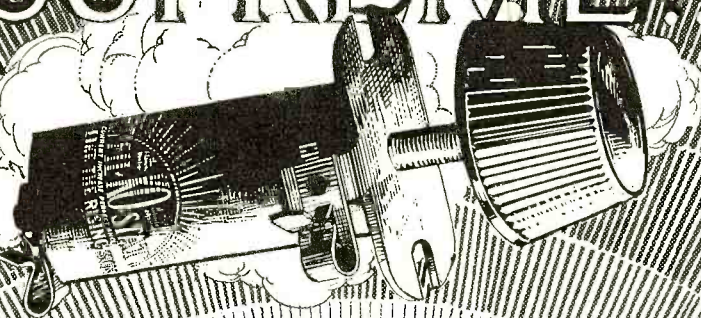

FIL-KO-STAT

SUPREME because it was designed to be supreme! That's the secret of FIL-KO-STAT superiority. Built to permit *infinite* adjustment of electronic flow in the vacuum tube—whereas other devices were drafted into radio service because, before the FIL-KO-STAT, there was no real *filament* control.

Put a FIL-KO-STAT in your set to-day. The maker's guarantee *assures* your satisfaction—and FIL-KO-STAT satisfaction means noise shut out—distance brought in—stations you never heard before.

FIL-KO-STAT has no screws to tamper with—no adjustments to puzzle—no discs to break or chip—no wires. It is *not* a powdered carbon rheostat—FIL-KO-STAT resistance element is 70% metallic substance. Its full resistance is 30 Ohms—only *two* terminals and you use them for *all* tubes, including 5-watt transmitting tubes. Triple tested and adjusted in the laboratory to the ideal "off" position for any of them.

GUARANTEED BY THE MAKER



Recommended and Sold by Dealers in High Class Radio Supplies

RADIO STORES CORPORATION

SOLE INTERNATIONAL DISTRIBUTORS

DEPT. RN 12—218-222 WEST 34TH STREET, NEW YORK
CHICAGO MINNEAPOLIS KANSAS CITY LOS ANGELES

Price

\$2

In Canada 215

FOR ALL TUBES

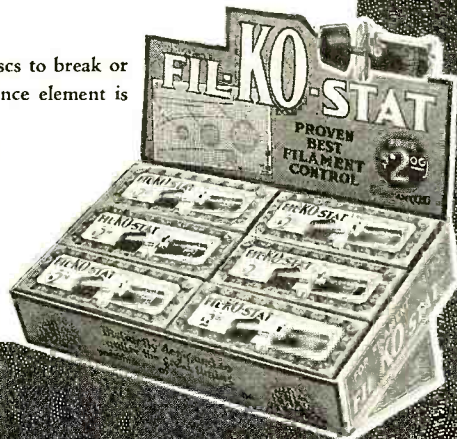

Erla Solderless Connectors Revolutionize Apparatus Assembly

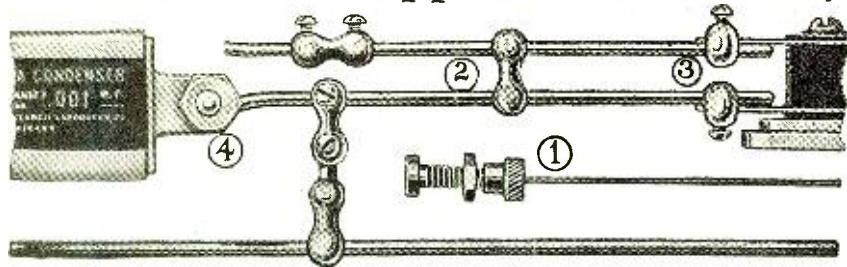

Manufactured with jeweler's precision, Erla phone plugs, handling two sets of phones at a time, are unequalled in quality and value. List, 75c



Providing utmost sensitiveness with perfect stability, the Erla fixed crystal rectifier is uniquely adapted for reflex work. List, \$1



Erla tested capacity condensers are unequalled in rigid unvarying accuracy, so vital to success in reflex work. Eleven sizes, 35c to \$1 ea.

Manufacturers—Erla solderless connectors create important savings in the assembly of receiving sets. Standardized operations are performed by unskilled workers in a fraction of the time required by soldering. Write for sample test shipment at maximum quantity discount

Every connection in radio apparatus assembly, including the difficult attachment of variocoupler taps to their respective panel contact points, is now successfully accomplished without the troublesome, dangerous use of soldering irons.

Those who have been dissuaded, through lack of mechanical ability, from building their own receiving apparatus, can now proceed with absolute confidence of success.

All possibility of injuring delicate, costly apparatus through soldering heat or the spilling of solder or acid paste is completely overcome. Moreover, minutes now suffice for work formerly requiring hours of patient, painstaking labor.

In disassembling and rebuilding apparatus, the advantages of Erla solderless connections are equally marked. No soldered joints need be broken. A simple turn with a screw driver, and the job is done.

In addition to saving untold trouble, time and labor, Erla solderless connections effect a final, direct economy through eliminating the cost of a soldering iron and its accessories.

Made in four types, as follows—1. Variocoupler, 5c ea.; 2. Bus Bar, 5c ea.; 3. Jack, 4c ea.; 4. Condenser, 3c ea.; Sold by progressive radio dealers everywhere. Or write us direct, giving your dealer's name.

Electrical Research Laboratories
Dept. C 2515 Michigan Ave., Chicago



an amateur. All the people who are making such a fuss should find out who to knock before they start. All the amateurs whom I have come in contact with have been only too glad to help me with any little trouble and have been courteous in the extreme. I think if there should be any adjusting done it should be in the government stations, not among the amateurs. Your readers should look into the interference question more thoroughly and try to find out who is at the bottom of it, then tell us your experience.

CHARLES S. LEWIS,
808 Kirby Building,
Cleveland, Ohio.

CODE

Editor, RADIO NEWS:

Upon reading the article sent to your magazine by Mr. H. S. Gowan concerning the use of the word "Code" to designate radio telegraphy, I should like to inform Mr. Gowan that he has no cause to feel that this term may indicate any impoliteness or that it is in any way a misuse of the terms.

The general use of the word code by the public to designate radio telegraph communication is absolutely correct. The use of this word by radio telegraph operators to designate what is properly termed "Cipher," does not change the meaning of the English language, but simply sets forth a careless misapplication of the word by radio operators.

If Mr. Gowan will consult Webster's Dictionary (unabridged), he will find code defined as "A system of signals for communication by means of telegraph, heliograph, flags or other signaling devices; as the Morse code, the International code, etc." Also find the definition of cipher as "A private system of characters or other mode of writing contrived for safe transmission of record or private communication."

RAYMOND M. JENKS,
278 Main Street,
Easthampton, Mass.

WHAT EXPERIMENTERS WANT

Editor, RADIO NEWS:

Just bought the October RADIO NEWS. Like your editorials—they show some thinking.

Your last line, "Get off the beaten track," should be taken seriously by the manufacturers; 90 per cent of them are "copy cats." Why don't they employ experts to help them turn out more efficient stuff?

I don't believe in turning out freak sets and parts, but I do believe that most of the manufacturers are about three years behind the advance in radio.

Where, for instance, can you find an experimenter's set? That is, a set with the main essentials (variocoupler, two variometers, two condensers, rheostat, socket, potentiometer, series-parallel switch, etc., and room on the panel to add a few more if desired). Connections to be made to plainly marked binding posts on the rear of the mounting board. Then the million or more hook-up fiends can indulge in their favorite sport by merely wiring the binding posts. The variometers to be made so they can be easily split. The cabinet to be double hinged so that top and back will both unhinge and lay flat on the table, making it easy to get at the binding posts or to add apparatus if desired.

Another instance. Where can you get a variocoupler that is easy to put on a panel? Why don't they turn out a variocoupler mounted on a sub-panel, tapped by tens and units with switches, that can be just slipped back of the main panel with only the shafts projecting through?

Still another instance. Why don't they make variable condensers with anti-capacity shafts?

14 RADIO FORMULAE AND DIAGRAMS FOR 50c.

PARTIAL CONTENTS



Measurement of Capacity of a Condenser. Two Methods. Two Diagrams.
Measurement of Inductance of a Coil or Circuit. Two Methods. Two Diagrams.
Measurement of Distributed Capacity of an Inductance. Diagram and Curve.
Measurement of Fundamental Wavelength of an Antenna. Three Methods. Three Diagrams.
Measurement of Wavelength of Distance Transmitting Station. Two Methods. Calibration of a Receiving Set. Two Diagrams.
Measurement of Effective Antenna Capacity. Two Methods. Two Diagrams.
Measurement of Inductance of Antenna and a Third Method of Measuring Effective Capacity of Antenna.
Measurement of Antenna Resistance. Substitution Method.

With this packet of radio knowledge you need never worry about schematic wiring diagrams, measurements and radio tables. All formulas and diagrams are printed on heavy paper in black and blue; and contained in two-color printed envelope, 9x12 in.

FOR SALE AT ALL DEALERS

THE CONSRAD COMPANY, INC.

233 Fulton Street

New York City

How Lively Is Your "B" Battery?

THIS IS NUMBER THREE OF A SERIES

Some people buy Eveready "B" Batteries oftener than other people. This is because each fan has different tastes and desires in radio receiving. Those that demand maximum volume—and to get it use many tubes, forcing them to the limit with high voltages on the plates—are eager and frequent buyers of these batteries.

Others renew them less often. They are the ones that are content with smaller volume and employ fewer tubes at lower plate voltages.

Furthermore, every radio fan, regardless of the tubes he uses, has his own ideas as to when it is time to strengthen the signals with fresh "B" Batteries. Some will long enjoy concerts that others would not consider loud enough. Just what is "too weak" is purely a matter of personal opinion.

These, then, are the things that determine how long you use your "B" Batteries—

1. *The number and kind of tubes.* The more tubes you use and the greater their power, the more current flows from the "B" Battery and the shorter is its life.
2. *The "B" Battery voltage.* The higher it is, the more current flows from the battery.
3. *The amount of negative grid bias ("C" Battery voltage) on amplifiers.* The greater the bias, the smaller the "B" Battery current.
4. *The life put into the battery in the first place by the manufacturer, and the freshness of the battery when you buy it.*
5. *The signal strength you wish.* The smaller the volume of sound you can enjoy, the longer you can use your "B" Batteries.

The life of any "B" Battery you can buy is affected by the above factors. Subsequent advertisements will set forth each factor in detail.

Eveready "B" Batteries predominate. There is more life in them—they last longer! Blocks of large cells, packed with energy, made especially for radio use, delivered fresh to your dealer, give you the most power for your money—power you can use loudly and swiftly, or softly and slowly, as you wish—Eveready for Everybody.

"the life of your radio"



The Metal Case Eveready "B" Battery, No. 766. The popular 22½-volt Eveready Battery in a new handsome, durable, waterproof metal case. At all dealers, \$3.00.

Eveready "B" Battery No. 767. Contains 30 large size cells, as used in the popular No. 766. Voltage, 45. Made especially for sets using detector and one or more stage of amplification. The most economical "B" Battery where 45 volts are required. At all dealers, \$5.50.



Eveready Radio Battery No. 771. The Eveready "Three." The ideal "C" Battery. Voltage, 4½ — three terminals permitting the use of 1½, 3, or 4½ volts. The correct use of this battery greatly prolongs the life of the "B" Battery. At all dealers, 70 cents.

Manufactured and guaranteed by

NATIONAL CARBON COMPANY, Inc.
Long Island City, N. Y.

EVEREADY

Radio Batteries

—they last longer

Note: This is Number 3 of a series of informative advertisements, printed to enable users to know how to get the most out of their receivers and batteries. If you have any battery problem, write to G. C. Furness, Manager Radio Division, National Carbon Company, Inc., 122 Thompson Ave., Long Island City, N. Y. Write for special booklets on "A," "B," and "C" Batteries.



Bristol One Stage Power Amplifier

A unit that can be used as a third stage without howling. The usual objections against a third stage of audio frequency amplification are entirely eliminated by the use of the new "impact" circuit.

The Bristol One Stage Power Amplifier does not require separate "A" or "B" battery. It uses common tubes such as U.V. 201A, 216A and V.T.2.

A remarkable achievement—a third stage audio that works RIGHT—install one today and give that distant station a chance to come in like the locals.

Ask your dealer or send for bulletin 3006-S.

Give your loud speaker a treat.

THE BRISTOL COMPANY Waterbury, Conn.

BRANCH OFFICES:
Boston New York Pittsburgh Philadelphia Detroit Chicago St. Louis San Francisco

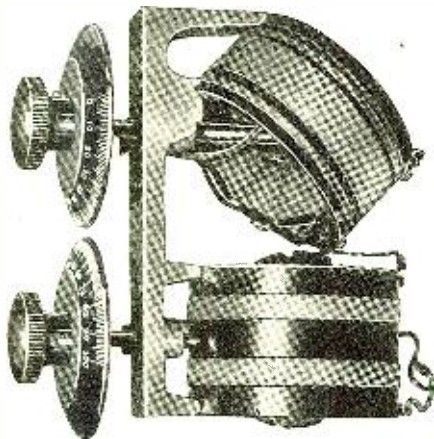

TRIP-L-KOIL

THE GREATEST RADIO DEVELOPMENT TO DATE. This new spider-web tuning coil

DOES AWAY WITH
VARIOMETER
VARIOCOUPLER
VARIABLE CONDENSER

Designed for single circuit regenerative sets. Affords utmost ease of operation and gives the selectivity of a two-circuit set. Tunes from 200 to 600 meters. Complete wiring diagram with each coil.

Patent Applied For

POSITIVELY AMAZING IN RESULTS. 142 stations were heard by an amateur AFTER ADDING THE "TRIP-L-KOIL" TO HIS SET. So designed that but two panel holes are necessary for mounting. No dials included.

SELLS FOR

9

DOLLARS

Go TODAY to your dealer. If he hasn't a "Trip-L-Koil" for you, see that he orders one. Or, write us direct, and we will give you prompt service. And if the "Trip-L-Koil" isn't all we represent, *your money will be returned.*

DESIGNED AND MADE BY

WHEELER-GREEN ELECTRIC CO.
ROCHESTER, N. Y.

ORDER OF YOUR DEALER OR DIRECT OF US

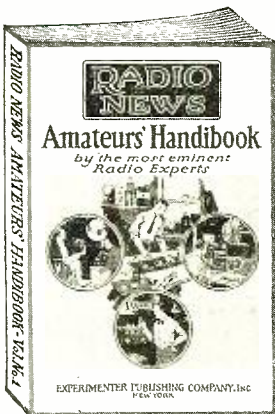

JUST THE BOOK YOU WANTED

"Radio News" Amateurs' Handibook

Volume No. 1

Chock full of radio constructive and instructive articles from cover to cover. Written by foremost radio authorities, in plain everyday language which everyone can understand. Sections include articles on Receiving Sets and Sundry Apparatus, Transmitters and Accessories, Radio Theory, Vacuum Tube Data, and Practical Hints for the Amateur. A book which also serves as a ready reference and should find a place in the library of every amateur. It contains 224 pages and over 375 illustrations, diagrams, and photographs, bound in a multi-colored heavy board.

On sale at all leading radio stores. If your dealer cannot supply you, pin a dollar bill to this ad and write your name and address in the margin below, and book will be forwarded to you postpaid.

EXPERIMENTER PUBLISHING CO., INC.
53 PARK PLACE, NEW YORK

PRICE, \$1.00

To sum up, why don't radio manufacturers show the same initiative, the same keen desire to improve their products that the automobile manufacturers show? What would the present day auto be if the automobile people were content to copy Mr. Haynes' original model? Can't the radio industry show more enterprise, and the spirit of American inventive genius?

There are too many gypers in the business trading poor apparatus for good money, and not enough well financed corporations, that can and will give the public what it wants.

A CHICAGO FAN.

IT PAYS

Editor, RADIO NEWS:

In regard to your section of fair dealing of radio manufacturers I refer you to the Connecticut Telephone and Electric Co. Last season I bought a head set of 3,000 ohms resistance. I lent them to another "Bug" and he returned them to me in a terrible condition. With two steps "doin' their darndest," I could scarcely hear even static. I sent them back to the company minus clamps and a few parts I thought unnecessary to send, as my box was small, and told the company to repair receivers and put a new covering on the head band and also replace cord.

They were returned to me with new receivers and other parts together with the parts I didn't send. There was no charge except for cord, clamps and head-band covering plus postage. This I consider another example of fair dealing.

FLOYD N. KENNEY,
Athens, Ohio.

AMATEUR RADIO IN CHINA

Editor, RADIO NEWS:

Having subscribed to your magazine, I noticed that you publish no news about the situation of radio amateurs in China, so I thought that some information might be of interest to your readers.

The first matter to consider is that all means of communication in China, including wireless telegraphy and telephony, are strictly reserved to the Government. This rule excludes the personal use of apparatus, such as radio sets.

Owing to the general disorder in China, this fact is being considered as a formality and while I am writing this letter we have about 35 amateurs, some of whom are novices, in town. I was first interested in radio two years ago, when Capt. S— volunteered to give lectures on this subject to the Scouts of the First Tientsin Troop, of which I am a member. This was when the Scouts' wireless class was formed, which was the first co-operation of Radio enthusiasts in Tientsin. Next came the Tientsin Amateur Radio Association. This was also started by Capt. S— in the early winter of 1922. After a few meetings, the membership extended to practically all the amateurs in Tientsin, including the Scouts, who entered as junior members. As the Chinese Government considers broadcasting dangerous in a political sense, we have none of it in Tientsin, so most of us are proper brass pounders, in spite of the fact that only three or four of us possess transmitters which are of the early spark coil type. I am one of the fortunate ones and you may be sure I was glad when they heard me a mile and a half away.

The Association possesses a ¼-kilowatt quenched spark gap transmitter, but it is in a state of experimentation and was used for a few nights only. At the last meeting of the T.A.R.A. it was decided definitely to procure a phone set in the autumn, to broadcast around the town, as the music we get by radio is only occasional, when the Peking-Tientsin Radiophone stations, which are now



Registered Trade-Mark

THE DAY-FAN

Tuned Radio Frequency Transformer

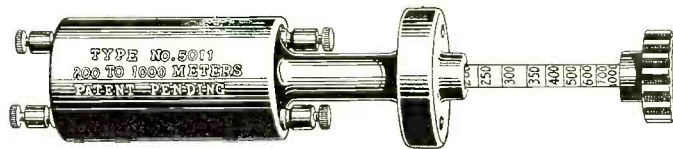

Is one of the most talked of products in radio circles today.

for
Instantaneous adjustment to any
public broadcasting wave length.

You are not getting all that is possible from a Receiving Set unless you are using the principles underlying the DAY-FAN Tuned Radio Frequency Transformer

Write for booklet free of charge.

The Dayton Fan and Motor Company
Established 1889
Dayton, Ohio.

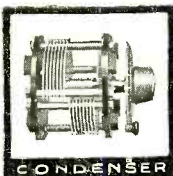

CONDENSER



VARIOCO - ER



the Most Successful Non-Magnetic Instrument

only \$7.50



\$7.50

The New 1924 Models are Now Ready

Even better than the 1923 Speaker that brought delight to thousands of radio homes. Two types, for single or double phone connections, same price. For use with your own phones. Heavy iron sound channels. Horn of heavy aluminum, with beautiful black indestructible finish. Fifteen inches high. Hear the Moon Loud Speaker at your dealer's. If he hasn't got it, order direct from us on our guarantee of satisfaction or refund.

Dealers—Write for Proposition.

Wilson Utensil Co.

Dept. R Dayton, Ohio

in the hands of Chinese and were built for them by the Western-Electric Co., put on a few phonograph records to amuse the operators.

As regards the receiving side, we (by I mean the amateurs in Tientsin) can be divided into three groups. The first and largest one consists of those who know very little about radio, but are much interested in constructing their own sets, usually crystal sets. The second is the one who has had a good deal of practice with crystals and has passed on to tubes, having acquired a deeper knowledge of the subject by a regular reading of books and magazines. The third group has the least members—they are either professionals and engineers or scientists. They all have proper tube receivers, mostly built by themselves.

All the above is written about the amateurs in Tientsin, but I will say a few words about other places of which I know very little, but where the conditions are similar to the above described.

Capt. S—, going on leave to England, and passing through Shanghai, took an active part in the formation of a Radio Club there, and as this organization is much larger than the similar one in Tientsin, it very soon succeeded in fixing up musical broadcasting programs, thus getting ahead of Tientsin. In other parts of China amateurs are limited to big centers and colleges.

The only messages we listen to are the commercial stations and ships. There are not more than 10 or 15 stations in operation during the day, or night, so there is not much QRM at all, this fact permitting the use of non-selective, single coil, crystal sets or loose couplers.

To conclude, I will say something to excuse our comparatively poor state of progress. The chief reason is that there are none of the necessary parts with which to build the sets, and every part must be home-made. These are difficulties which often completely stop the building of a set for a fortnight or so. Only about a month ago two electrical stores obtained radio goods, but unfortunately they sell them at an extremely high price. But in spite of that, we all hope that the conditions will turn in favor of the amateur and that he will be as prosperous here, in this country, as the fellow amateurs overseas.

D. TIEDERMANN,
Russian Consulate Building,
Tientsin, China.

HOVEY IS RIGHT

Editor, RADIO NEWS:

I was quite surprised to see that you had reproduced my peculiar circular letter on page 256 of September issue of your splendid RADIO NEWS. That letter sure started things. I have received a large number of letters from manufacturers of sets and parts, highly commending my system of Radio sales, and offering to send me sets and parts for demonstration on my Radio Car. I have received something else, too, and that is a grist of letters from every corner of the United States from fellows who say "That is a scheme I have been thinking about. Can I come to Oklahoma and go it with you on the game?" Now I am not answering this big grist of letters for the simple and excellent reason that out of about eighty of these fellows just one was thoughtful enough to enclose a stamp for reply. So I am asking you to give space to this "shot" which will probably answer all of them, for they are all evidently readers of RADIO NEWS.

All I have got to say to you fellows is this: Yes, the scheme is good. The plan in full was published. It cost you nothing. Now if you haven't got the brains and the pep to get that plan going right where you live, for God's sake what good would you be to me out here in Oklahoma? What are

Reflex Reception Revolutionized

The uniformly satisfactory results obtained by owners of crystal sets have fully demonstrated the superiority in reflex reception of

M. P. M. Million Point Mineral

Unsolicited testimonials from all over the country show marvelous records up to twelve hundred miles, both with and without amplification.

These crystals will not corrode, burn out or lose their sensitiveness; and clear, musical reproduction is assured. If you are not getting the results you should from your reflex set, ask your dealer for M.P.M. or send us \$.50 for two unmounted, or \$.70 for two mounted; and, in addition to crystals, we will send you diagram of a reflex circuit that we guarantee will give absolute satisfaction.

M. P. M. SALES
COMPANY

Dept., N.



247 So. Central Ave.
Los Angeles
Calif.

THE WORLD'S GREATEST
RADIO CRYSTAL

DX—PHANTOM—CIRCUIT
No Aerial—Ground—Loop required—Just a piece of wire laid on floor or ground brings in near and far stations wonderfully free of static and interference. With one tube and 50 feet of wire laid on floor user writes: "I had Chicago, Minneapolis, Denver at 9 a.m. Night reception COAST to COAST. P. Ewing, Hardin, Montana." Vesco simplified circuit is easily operated, but one control for tuning in. Dry cell tube may be used for portable set. Inexpensive to make as few parts are needed. Quickly constructed by the inexperienced from our complete instructions sent postpaid for 25c., including hook-up of two-stage amplifier. Stamps accepted.
Box 117 VESCO RADIO SHOP, Oakland, Calif.

NOVO

"B" BATTERIES

WITH INSULATED BINDING POSTS
& DETACHABLE WIRE CONNECTOR

NOVO M'FG CO.

424 W 33rd ST. NEW YORK - 531-50 DEARBORN ST CHICAGO.

MAGNAVOX Products

EVERY condition in the art of radio reproduction is most successfully met by Magnavox apparatus.

Reproducers

- R2 with 18 inch horn \$60.00
- R3 with 14 inch horn \$35.00
- M1 with 14 inch horn; for dry battery sets . \$35.00

Combination Sets

- A1-R consists of Magnavox Reproducer with 14 inch horn and 1-stage Amplifier . . . \$59.00
- A2-R same with 2-stage Amplifier . . . \$85.00

Power Amplifiers

- A1-One-stage . . \$27.50
- AC-2-C-Two-stage 55.00
- AC-3-C-Three-stage 75.00

Radio users will be sent new 32-page Magnavox Radio Catalogue on request.

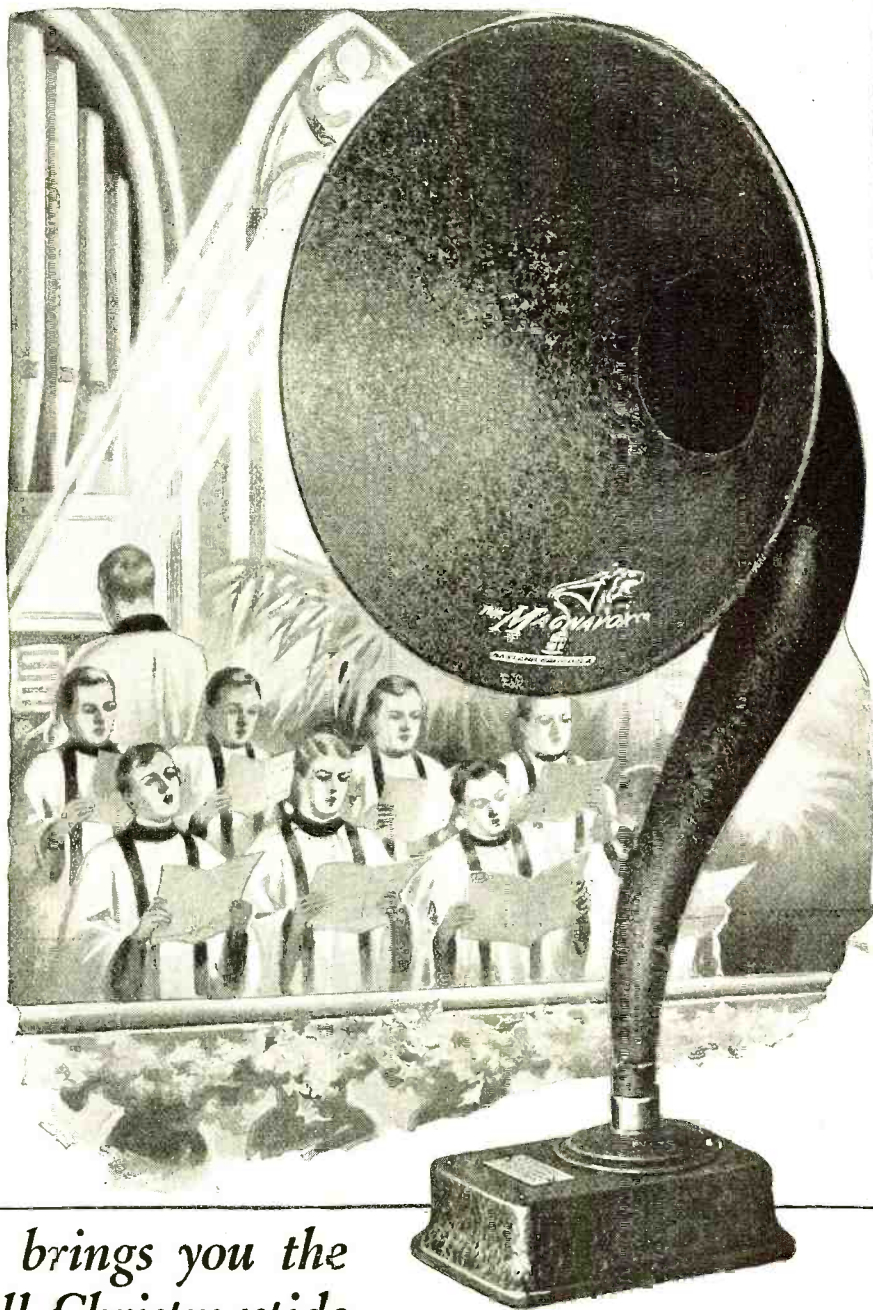

Magnavox brings you the Voice of All Christmastide

THE Art of Radio Reproduction is enjoyed by every Magnavox owner. Despite the ever-increasing quality and variety of Broadcast Programs, many a receiving set gathers dust unlamented because of insufficient sensitivity or an unsatisfactory "loudspeaker."

Every Magnavox owner is a master of the art of radio reproduction—the results obtained by the use of Magnavox Reproducers and Power Amplifiers cannot be equalled with apparatus constructed in the ordinary way.

The special attention of dry battery receiving set owners is called to the new Magnavox Reproducer M1, illustrated above.

Magnavox Products can be had of good dealers everywhere.

THE MAGNAVOX COMPANY
Oakland, Calif.

New York Office—370 Seventh Avenue
Perkins Electric Limited—Canadian Distributors
Toronto, Montreal, Winnipeg

MAGNAVOX PRODUCTS

There is a Magnavox for every receiving set

It's the Contact that counts



Adapter No. 429 for 199 Tubes, 75c



De Luxe No. 400 Price 75c



Small-space, No. 401 35c, 3 for \$1.00



Na-ald W.D.II No. 411 Price 75c

A CAREFUL examination will show that each contact in Na-ald sockets and adapters is of a wiping nature on a broad surface, and so designed that strong tension is permanent, no matter how often the bulbs may be removed or how much the connecting prongs in the tubes vary.

Na-ald sockets are moulded of Bakelite, with uniform cross-section and cure, and other engineering features incorporated to avoid plate to grid losses and to insure that each tube develops its fullest efficiency.

The new Na-ald dials combine rare beauty of design with highest efficiency in use. These dials are moulded from genuine Condensite in such a way that absorption losses are reduced to a minimum. Knobs are so shaped that fingers do not conceal clear numerals and graduation on the bevel of Na-ald dials.

Na-ald Circuit Booklet packed with each Na-ald product

Write for "Why a Bakelite Socket?" and other descriptive literature

Alden Manufacturing Company

Manufacturers of sockets and dials for every radio requirement
Dept. K. 52 Willow Street
SPRINGFIELD, MASS.
Cable Address, Aldenco

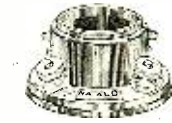

Na-ald Special Socket No. 499 for U.V.199 Tubes. Price 50c

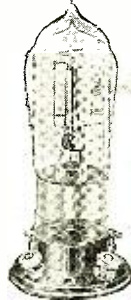

Two-in-One Socket for W.D.II and 200 Tubes No. 450. Price 50c



No. 3783-3/16" insert 3784-1/4" insert. 3/8" Dial. Price 75c. 2 and 3" Dials 35c. 3 for \$1.00

you made of anyway? The plan can be worked anywhere. Wake up and work it and show what you are made of. Don't expect me to furnish a boat to go fishing in, and then expect me to row the boat, bait your hook, and even catch the fish for you. Quit dreaming and do something yourselves, and for the love of Mike and all his kids, when you write to anyone asking favors, show that you appreciate a reply from a busy man at least to the value of a two cent postage stamp. Hoping this broadcast comes in clear to you, I am signing off.

O. H. Hovey.

BROADCASTING AND THE SALE OF SHEET MUSIC

Editor, RADIO NEWS:

For some time I have been watching this silly controversy which was stirred up by the Society of Authors, Composers, and Publishers, as against broadcasting stations, and I must say that my own sympathies are entirely with the broadcasters. Perhaps the fact that I am an ardent radio fan has prejudiced me in this regard. However, herewith is a list which may shed a little light on the situation insofar as music is concerned.

Our family is very much like thousands of others. We have had a piano for a good many years, but due to the fact that we are inclined to be stay-at-homes, we didn't get much opportunity to hear the new music. About a year and a half ago I became seriously affected by one of the most virulent forms of radio-itis, thereby being forced to listen to all the new tunes. Here is the result: During the last year we have heard, enjoyed, and purchased the following pieces of sheet music:

- "Land of the Sky Blue Water" (heard Cadman himself play it).
- "Carolina in the Morning."
- "March of the Wooden Soldiers."
- "Love Tales."
- "Ten Little Fingers and Ten Little Toes."
- "My Sweetie Went Away."
- "Nobody Lied."
- "Carolina Mammy."
- "Yes, We Have No Bananas."
- "Swinging Down the Lane."
- "I Love Her, She Loves Me."
- "Roses of Picardy."
- "Stella."
- "Apple Sauce."
- "Runnin' Wild."
- "Barney Google."
- "Marcheta."
- "Smilin' Through."

It's really too bad the way the broadcasting of popular music must be hurting the royalties of the above-mentioned Society.

Sincerely yours,

JOHN W. LAWTON.

Brockway Variable Condenser

Revolutionary Construction—Unique and Simple

EASIER TO ADJUST

than a vernier. Two full revolutions of the dial (720 degrees movement) allow a wide range for fine adjustment, making accurate tuning quick and easy.



SAVES SPACE

behind panel for other instruments. Mounts entirely on front. Consists of only two spring bronze plates, separated by mica dielectric, mounted in genuine bakelite.

New Exclusive Feature—Plates are scientifically formed to properly control the capacity curve. Gives higher efficiency in RADIO FREQUENCY, REFLEX, NEUTRODYNE and OTHER CRITICAL CIRCUITS.

Reduces radio frequency losses to minimum, thus receiving at greater distances. Improves any circuit requiring 11 to 43 plate condenser.

If your dealer hasn't the Brockway in stock, ask him to order for you. Or, we will send one postpaid on receipt of price with dealer's name and address.

PRICE \$3.50

BROCKWAY LABORATORIES COMPANY, Toledo Factories Building, Toledo, Ohio

MONTRÖSE CONDENSERS

The Condenser with the Genuine Bakelite End Pieces	
11 Plate Vernier	\$2.20
23 Plate Vernier	2.55
43 Plate Vernier	3.35
Vernier Condensers Include Dial	
3 Plate Plain	.75
11 Plate Plain	1.20
23 Plate Plain	1.55
MONTRÖSE MANUFACTURING CO.	
1200 Bedford Avenue	Brooklyn, N. Y.

YOU DON'T NEED TUBES

to get out of town. If you want new stations on your crystal set WRITE ME TODAY. Mine works 400 to 1,000 miles without tubes or batteries! Thousands have bought my plans and now get results like mine. CHANGES OFTEN COST LESS THAN A DOLLAR. Send self-addressed envelope for further information. LEON LAMBERT, 595 South Volusia, Wichita, Kansas.

Fertile Florida

(Continued from page 695)

the Everglades. The President golfs in Florida, followed by a distinguished gallery of office seekers, and democratic critics waiting to see if what he drinks at the nineteenth hole agrees with his expressed opinions on the eighteenth amendment. These are but a few examples; they could be multiplied indefinitely.

The fact that the concentration of greatness at a half dozen points within easy reach of each other presents an unusual opportunity has not escaped the attention of persons who travel for business purposes. A good many seeds planted in Florida sprout into business deals elsewhere. Wherever there is a man of influence there is always someone trying to get to him through the crowd of real estate dealers who get there first and stay longest. But though

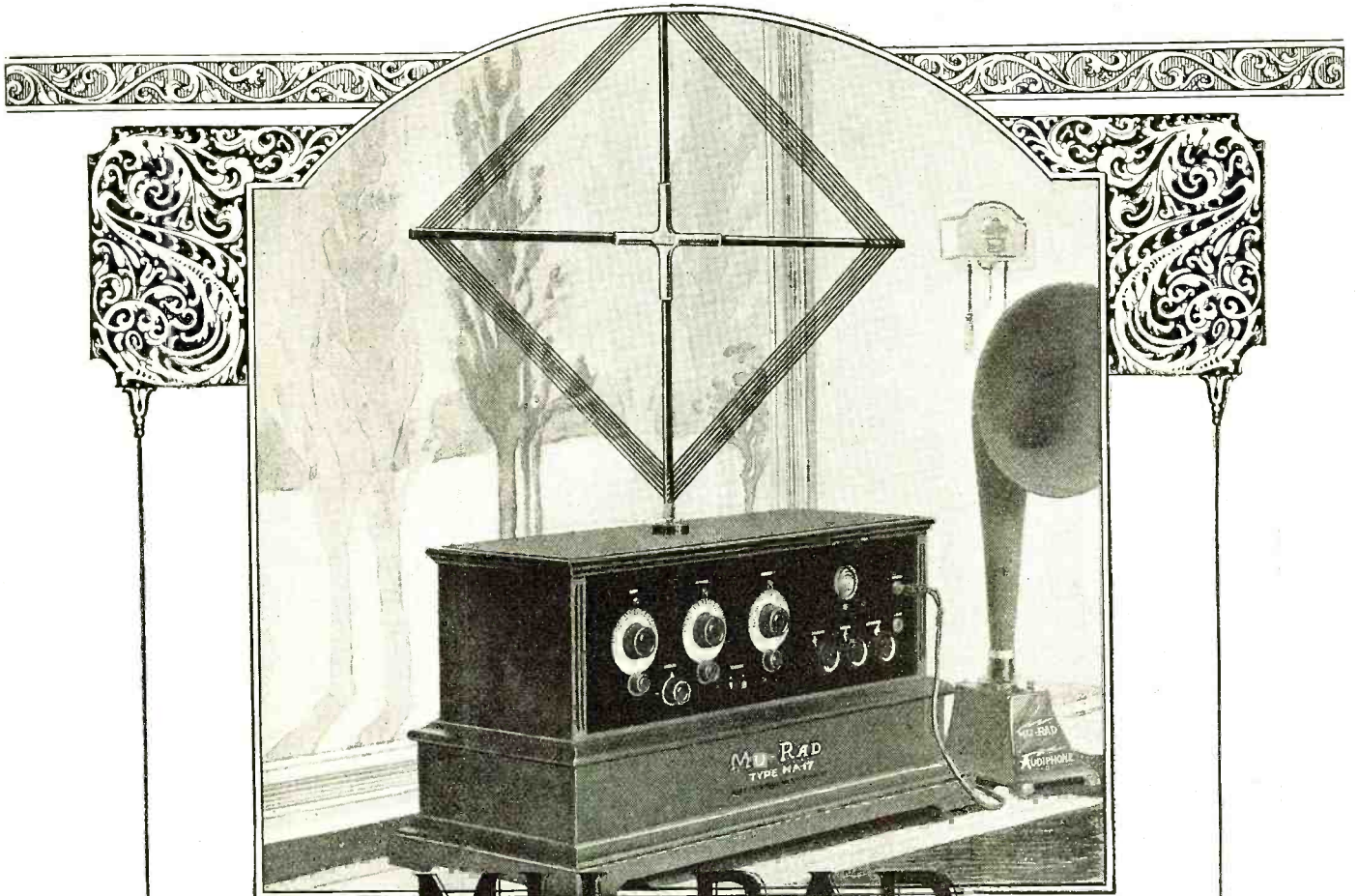

MU-RAD RECEIVERS

NEW MU-RAD RECEIVER MA-17

MU-RAD, in the vanguard of the radio art, once again blazing a new trail of progress. Years of scientific achievement anticipated in this *super set*, the MU-RAD MA-17. A new sensitivity, greater distance, fuller volume, with the absolute simplicity and substantial construction of the famous MU-RAD MA-13. Most recently discovered principles are embodied and developments of the future thoughtfully considered in the designing of the MU-RAD MA-17.

Three stages of radio and two of audio frequency amplification and detector. One tuning dial and two selecting dials, each independent of the other. Plug-in type r. f. transformers to care for changes of tube type or wave lengths. Panel-mounted volt-meter for quick reading of A and B batteries. Solid mahogany, Adam Brown hand-rubbed finish cabinet with loop fitted into top and compartment in base for "B" batteries. Guaranteed for 1000 miles reception using only a 2-foot loop.

DISTRIBUTORS OF THE MU-RAD DEALERS COOPERATIVE POLICY

MU-RAD LABORATORIES, INC.
801 FIFTH AVE. ASBURY PARK, NEW JERSEY

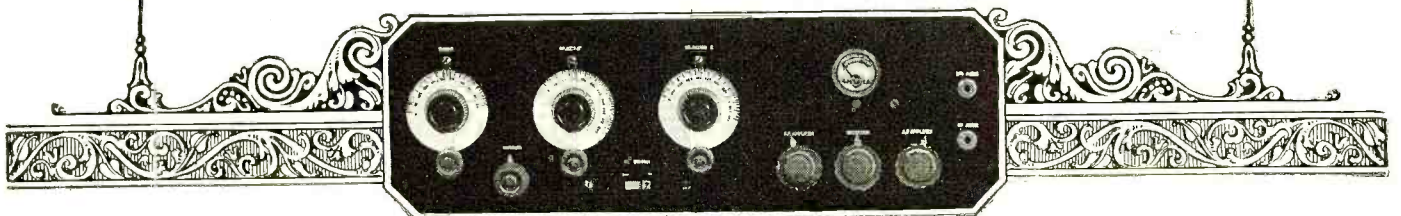

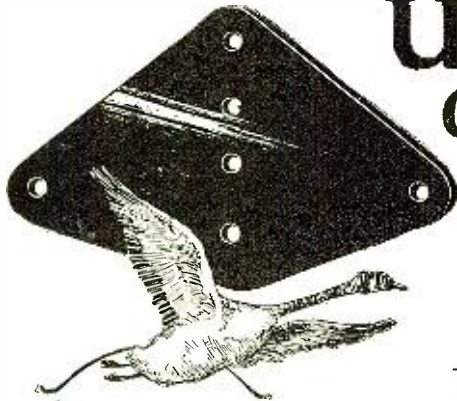

U.S. TOOL CONDENSERS

WITH THE PERFECT
END PLATES OF
LAMINATED
CONDENSITE
CELORON

Moisture need not be absorbed but only retained on the surface of insulating material to allow the escape of radio frequency currents. Moisture vanishes from the surface of *Condensite - Celoron*, like "water off a duck's back." Also has the highest dielectric and tensile strength.

MANY cheaper materials might do as well for ordinary purposes as *Condensite-Celoron*. But our high respect for the good opinion of the radio public warrants our giving this added value. Just one of the scrupulous details by which we make certain that every *U. S. Tool Condenser* gives unflinching satisfaction. In the long run it pays to be particular and insist upon **U. S. TOOL CONDENSERS**.

U.S. TOOL COMPANY INC.
118 Mechanic St.
Newark, N.J.

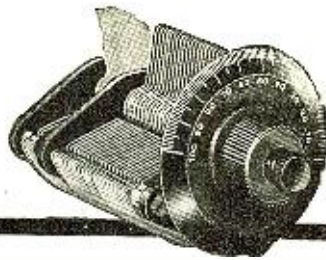

I went up and down the coasts and back and forth through the interior for three months last winter, I was unable to find anyone who had discovered the radio opportunity in Florida.

Jacksonville, which is the gateway to the Land of Flowers, has a broadcasting station operated by a newspaper. If you read that newspaper you can find out all about the programs, but I asked a number of radio users outside of Jacksonville about it and they said they never heard of it. Some told about the programs from Atlanta and Fort Worth and some mentioned Denver, but Jacksonville seems to be of only passing interest because, following the lead of the "amateurs," the radio fans want distance, even if they have to sacrifice distinctiveness to get it. Chicago and Seattle folks no doubt listen in for Jacksonville regularly.

Here and there are found technical amateurs who hear and work other amateur code stations. Their work is little known by the public. Apparently they have had little to do with the broadcasting situation. One of the best is an Orlando boy who, in spite of the discouragement caused by the malicious destruction of his aerial by persons unknown, kept on and achieved notable results. Another, on the west coast, maintained communication with a military post, connecting it with Washington for several days when the wire systems were wrecked by a storm.

Miami has broadcasting and the station has received many acknowledgements, but in spite of careful inquiry among casual acquaintances I was unable to discover any who could tell me anything about the programs or how well they came through. The general public seemed less interested in the station than were fans further up the coast.

Two years ago I had some correspondence with a Florida concern that had a novel idea. It was going to operate sight-seeing boats on a river. It was not going to run them up the river, where I supposed the scenery was, but down toward the ocean. They wanted the best radio equipment that could be purchased for the purpose of bringing in the broadcasts. I gave them the best advice I could, and the names of many reliable manufacturers, and heard no more, aside from a grateful acknowledgement, until last winter. The boats were for sale. I could not ascertain whether radio failed or whether the scenery was disappointing in the direction of the three-mile limit.

There were quite a few antennae along the east coast. I saw one on one of the roads connecting the coast and Lake Okeechobee. On the most traveled highway in the state I counted 133 houses between one aerial and the next. On a cattle ranch of 2,500,000 acres down the Kissimee River, is a little village for the manager and the cow-boys. It is named Kicco and pronounced "Kiss-o," not "Kick-o." It is a gem in the wilderness, with pretty cottages, a big company store, cold storage, electric lights, a good school, an athletic field and an aviation field where visiting airplanes land, but it has no radio in spite of its isolation. Another ranch down the river had a receiving set and an excellent aerial.

Over Gainesville way, near the State University, radio was not enough in evidence so that the man in the street could give any information. At Okeechobee City, and Moore Haven, on Lake Okeechobee, radio was not a factor in either business or pleasure. At St. Petersburg there was some talk of buying the government station and using it for broadcasting, as the government was offering it for sale, but there seemed to be no immediate action in prospect.

There were no aeriels visible from the highway at the residences of Ford, Edison, Bryan. There was none that I could see at the home of Kirk Monroe, the famous writer who has been the idol of boys of three

USE THE UNIVERNIER

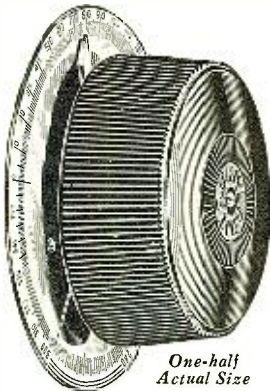

One-half Actual Size

1. To obtain and maintain accurate adjustments.
2. To make your set 100% more selective.
3. To bring in more DX stations.
4. To eliminate most body capacity.
5. To improve the appearance of your set.
6. To obtain continuous vernier adjustment throughout entire range of your set.
7. To make plain condensers and other tuning apparatus more efficient than the so-called vernier types.

The Univernier is a knob and silver plated 360° scale with a self-contained mechanism which reduces motion of the shaft to the knob 12 to 1.

As easily installed as the ordinary knob. Makes variocouplers, variable condensers, variometers, tickler coils, variable radio frequency transformers, potentiometers, and many rheostats all vernier in action. Eliminates trouble from unbalanced instruments. A necessity on neutrodyne and other hookups.

Highest Radio Authorities agree that the use of the Univernier is the only logical and correct method for obtaining vernier adjustment of radio apparatus.

MADE IN TWO SIZES: No. 251 for 1/4" shafts.
No. 188 for 1/16" shafts.

LIST PRICE \$1.25

At your dealers or post-paid upon receipt of the above amount.

DEALERS and JOBBERS Write for Discounts.

WALBERT MANUFACTURING COMPANY

935 Wrightwood Avenue

Chicago, Ill.

FREE Complete Price List
AITKEN RADIO CO.
504 Superior St., Toledo, O.

PROLONGS LIFE OF TUBES
AMPERITE
CURRENT ADJUSTER
ELIMINATES RHEOSTATS
AUTOMATIC FILAMENT EXPELS ALL TUBE TROUBLES
FROM YOUR DEALER OR
RADIALL COMPANY
99 WARREN STREET NEW YORK \$1.10 WITH MOUNTING



Multi-Plug \$2.00

“Better Workmanship and a Finer Finish”



Sta-Put Plug 40c



Shur-Grip Plug \$1.00

You will be interested in the design of our new Multi-Plug and our new miniature single plug. With the old reliable Sta-put and the handsomely finished Shur-grip they complete the best line of Radio plugs in the world.

See them at your dealers.



Sta-Put Jr. 50c

**MANUFACTURED BY MARTIN-COPELAND COMPANY
PROVIDENCE, RHODE ISLAND**

**MAR-CO
RADIO PRODUCTS**



CONTINENTAL

"New York's Leading Radio House"

CROSLEY-XJ

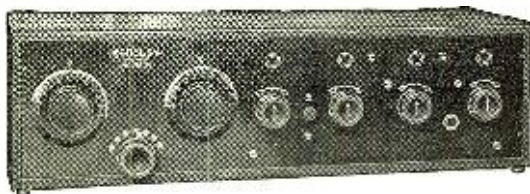

New Broadcast Receiver

**Better—
Costs Less**
Crosley Products meets the demand of every Radio user both in cost and quality.

This set consists of one stage of tuned radio frequency amplification, detector, and two stages of audio frequency amplification.

This set is very similar to the well known Crosley Model X. It is equipped with new parts including the new Crosley Condensers having moulded plates, mould composition sockets, and new Miltistats in moulded cups.

A good set at a popular price means quick turnover.

2659-Q

CONTINENTAL RADIO and ELECTRIC CORPORATION

SIX and FIFTEEN WARREN STREET, NEW YORK, U. S.

RADIO SE-AR-DE PRODUCTS

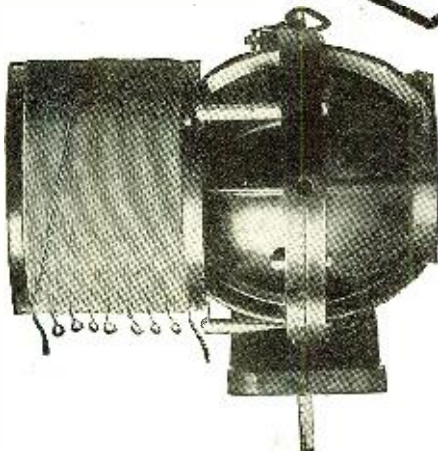

SE-AR-DE Molded RADIOMETER

Build Your Own Single Circuit Tuner

CATALOGUE No. 165

\$13.00

Range 180—3100M
" 300—3280M

R. MITCHELL & CO.

255 ATLANTIC AVENUE

BOSTON, MASS.

USE VAN'S LIQUID COPPER

for shielding back of panels, etc., eliminates body capacity. Van's Liquid Copper takes the place of sheet copper or aluminum. Easily applied with a brush—no cutting, drilling, soldering or waste. One bottle covers 400 square inches; mailed to you for \$1. Send a Dollar bill today.

VAN LABORATORIES

4845 N. Lowell Ave.

Chicago

Operate your radio from your lamp socket with a

Gould Unipower Battery

For complete information address

GOULD STORAGE BATTERY CO.

30 East 42nd Street

New York

generations and who, if he would write a radio story, would start numberless youngsters in the radio game. The only place in which radio was being used to assist in the tremendous operations of producing and moving the fruit and vegetable crops, so far as I discovered, was at Sanford during the celery season and at Hastings when potatoes were being shipped. The Department of Agriculture maintained a receiving station at the former city for a month and then moved it to the latter. It brought in market reports from Washington and from marketing centers.

From the standpoint of radio, Florida is a big fertile field, capable of untold cultivation and yield, but scarcely touched as yet. Even the real estate agents have not discovered that radio can be used in selling property, and that proves, if nothing else does, that radio has not made an impression on the state. Approximately 110 per cent of the regular residents of Florida sell real estate, or try to. If the entire area of the state should change hands every season, some of them would still die of starvation for the lack of commissions unless they had other resources. You can't hire a taxi in Florida without buying a house and an orange grove, unless you can prove to the driver that you have not a cent in the world above the actual fare. Eventually every visitor buys something and prices are always rising. If the real estate agents ever take up radio, the factories will have to work night and day to keep them stocked up. But so far radio with them is nothing more than an interesting newspaper item. When I told them that an old friend of mine had used four periods of fifteen minutes each on a New York broadcasting station at an expense of \$160, and had traced more than \$10,000 in sales directly to this advertising, they were interested.

In Miami I asked a radio dealer why he did not get some receiving sets into the homes of prominent people, to give the game a start. He said he had planned such a campaign, had \$50,000 worth of business in sight, had his capital arranged for, and then was told that the man who was going to supply the cash had met sudden reverses and was unable to go ahead with the matter. In Kissimmee I inquired why there were so few sets and the dealer said that he had sold one the winter before, a high priced one, and that neither he nor the district distributor had been able to make it work satisfactorily. In spite of what failure meant in a town where everybody would hear of it, the sale ended in a fizzle that cost the dealer a lot of money, and set radio back several years. But a farmer who made his own set was getting fine results.

There are difficulties in Florida that may account for the lack of vigorous promotion. Chief among these are atmospheric conditions. The dealers, practically all of whom carry radio apparatus only as a small line in connection with electrical or other business, lack confidence in their ability and that of their patrons to get satisfactory results. Yet there are radio users in the state who get results. I met some of them. The operator at the government station in Hastings was making no complaint, but was bringing in Washington and, in off hours, pulling in concerts for the entertainment of his friends. If practical demonstrations could be given, with the prospective customers operating the receivers themselves instead of watching the dealer twirl the knobs, and if the gospel of getting the program from the nearest station should be preached instead of the technical amateur's ideal of trying to get the one that is farthest away, there is no doubt that sales would be made in large numbers and customers satisfied.

Your Kellogg Radio Christmas

Here is a way to get a wonderful receiver of Kellogg parts that most radio fans will tell you, are the most reliable, durable and efficient on the market. In several million families this year, each of us will be buying cigars, neck-ties, safety razors, books—racking our brains to think of something to please each member of the family.

Forget all this trouble and work, and plan a radio Christmas. Ask the boy or dad to make up a list of reliable parts for a simple set; then each one buy one part for someone in the family, and "the night before Christmas" will find a receiving set in your living room that will bring you, not only Christmas carols, church services, but a further great variety of entertaining, instructive and news features that you can select at will, if you have efficient Kellogg parts carefully put together.

Such assembling is an easy matter with Kellogg radio equipment. There are thousands of circuits, some very efficient, both as to distance and selectivity, that require only a condenser, coupler [or variometer], tube socket, fixed condenser, grid leak, tube, dials, and a few other inexpensive parts. You don't need to buy an expensive cabinet to have a good radio set.



If your dealer does not handle Kellogg, send us his address. We will send you our radio hand book, which you will find helpful if you are a radio fan, and one that will surely arouse your interest if you are not.

Start today on your Christmas receiving set, and make every member of the household happy.

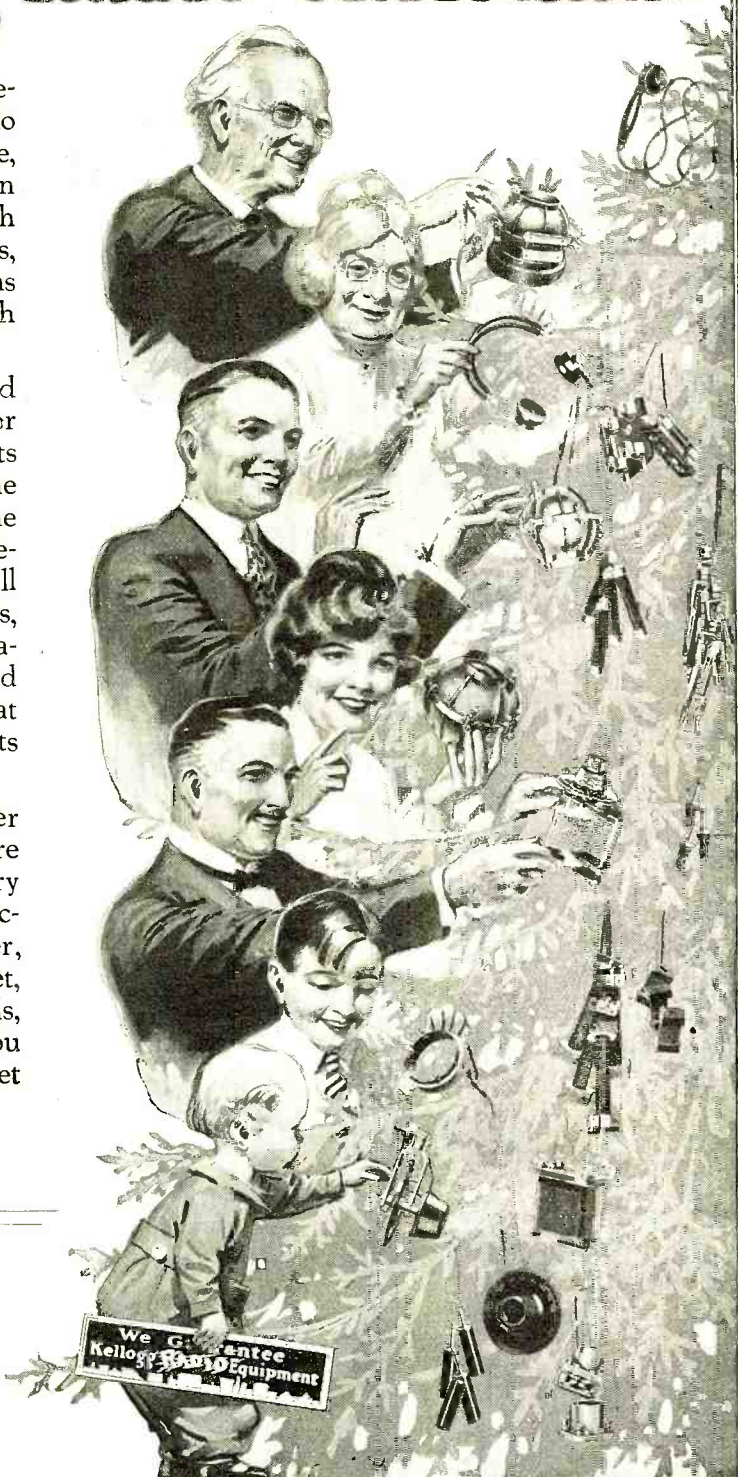

KELLOGG SWITCHBOARD & SUPPLY COMPANY

CHICAGO, ILLINOIS

Connecting
Detaching

The Plug You'll Welcome

A real innovation in a Radio Plug—made by a concern whose reputation and standing, as the leading authorities in the electrical instrument field, has been unquestioned for 35 years.

To YOU—it means the convenience of being able to connect or detach your phone cables instantly—without tools or broken fingernails. To connect merely shove in the cables—to disconnect press the triggers and pull the cables out. Perfect contact always. Saves time in transferring from one set of cables to another—and consequently often the number of plugs required. Initially designed for this concern's own exclusive use in its experimental laboratories—but now obtainable by you. No up-to-date outfit to-day is complete without it.

At All Dealers—\$1.00 Your order will be filled direct by mail if your dealer cannot supply you.

WESTON ELECTRICAL INSTRUMENT CO., 173 Weston Avenue, Newark, N. J.
Branch Offices in All Principal Cities

Electrical Indicating Instrument Authorities Since 1888

WESTON

STANDARD - The World Over

"Where ignorance is bliss 'tis folly to be wise"

—but that is no excuse for not using the acknowledged best audio transformer—

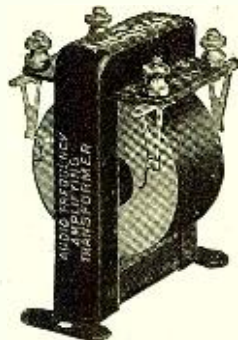

The AMERTRAN

—REG. U.S. PAT. OFF.—

—acknowledged by professional radio engineers to be the STANDARD OF EXCELLENCE for audio amplification.

The reason for this is apparent in the Amplification Chart shown in our Circular No. 1005.

Turn ratio, 5:1. Amplification ratio, 30-40 times audibility in the flat part of the curve.

American Transformer Company

Designers and builders of radio transformers for over 22 years.

PRICE \$7.00
Ask your electrical dealer, or, sent carriage charges collect. (Wt. 1 lb.)

177 Emmet Street Newark, N. J.

The magnitude of the opportunity is beyond computation. There are fishermen who live in boats, called "camps," on Lake Okeechobee and its tributary for several months a year. Whole families live in one boat, only going ashore on Saturday night with the exception of the crew of the "running boat" that takes the catch to the icing plant. I visited one of these while a catch of catfish valued at \$150 was being cleaned. I was told that this was the average daily catch. A fellow who went around to these camps with a radio receiver and let these folks get their fingers on it would hardly be permitted to take it away when a day's income would pay for it.

From Okeechobee north, there is a wilderness that is in practically the same condition as when Columbus discovered America, but here and there are ranch houses and camps where money is not lacking and where entertainment to break the monotony is sorely needed. The sportsman and tourist get all excited about its alligators, big birds, wild turkeys, deer, bear, rattlesnakes and Seminole Indians, but folks who spend their lives there would be glad to hear a voice from afar.

On the Kissimmee, run a few stern-wheel steamboats. A trip on one of these is the greatest back-to-nature experience available to the tourist today. When the Roseada passes the canal at Southport, on Lake Tohopekaliga, the passengers enter a new and strange world. There is always the certainty that they will be out of communication with the outside world for at least a day or two at a time. If they are care free they will be glad of it, but if they have interests that may demand attention, they need radio. This primeval paradise will be the mecca of sportsmen and nature lovers in years to come. The boats shall be radio equipped, and could be, if the opportunity were properly developed. There are boats on Lake Okeechobee carrying passengers en route across the state, and a number of coastwise crafts that should have radio equipment also.

Moore Haven, almost isolated on the lake shore with only a branch line railroad with infrequent service, and the lake and canal boats, ships tomatoes and beans not only by carloads but by trainloads. Its inexhaustible muck, fifteen feet deep in places, and capable of being used either as soil, fertilizer or fuel, produces crops whose principal fault is that they are almost too big to handle. It emerged from a flood last winter and went about its business with a courage that would conquer easily any little difficulty such as is encountered in radio. Radio would be valuable, for in handling a crop as perishable as tomatoes the state of the market at the time of shipment is of tremendous importance.

Sanford's celery crop runs into the millions. Hastings growers collected for the trainload of potatoes they shipped one day when I was over there \$114,000. These two points are the only ones except the Navy stations and Army posts, I believe, that have government radio service and they have it only during the principal shipping month. They should have radio market reports all the time, and radio entertainment for evening hours. In Gainesville a colored lady on whom the local grocer had taken what seemed to be a long chance, bobbed up serenely one day with a check for \$1,300, that she had just received for cucumbers, and cleaned the slate. Would that "cullud pusion" have invested in a nice, new shiny aerial with a receiver at the bottom to stimulate the envy of the neighbors? Leave it to 'Liza Jane! I saw a police court justice extract from a "good luck doctor" a twenty dollar bill that he had collected from a lady field hand for a charm made from a small bundle of rags. Such ladies could buy radio

(Continued on page 790)

CARTER Inductance Switch \$2.00
List
Positive Contact Each Point.
1-15 indicator on dial. Pigtail connection eliminates friction contact. Soldered terminal and contact, one piece. Only one hole to drill in panel. Ask your dealer. Catalog o. New Carter Improved Radio Products on request.
CARTER RADIO CO., 207 So. State St., Chicago

"DV" (Deep Vein) Radio Crystals
Every crystal long distance tested—Guaranteed. Prices right to Dealers and Users. Live representatives wanted in every large city.

W. E. Skinner
General Distributor
Minneapolis, Minnesota

JUST OFF THE PRESS

12th Edition

WIRELESS COURSE IN 20 LESSONS

By S. GERNSBACK, A. LESCARBOURA and H. W. SECOR

Very Greatly Enlarged

Price

\$2.00

Post paid

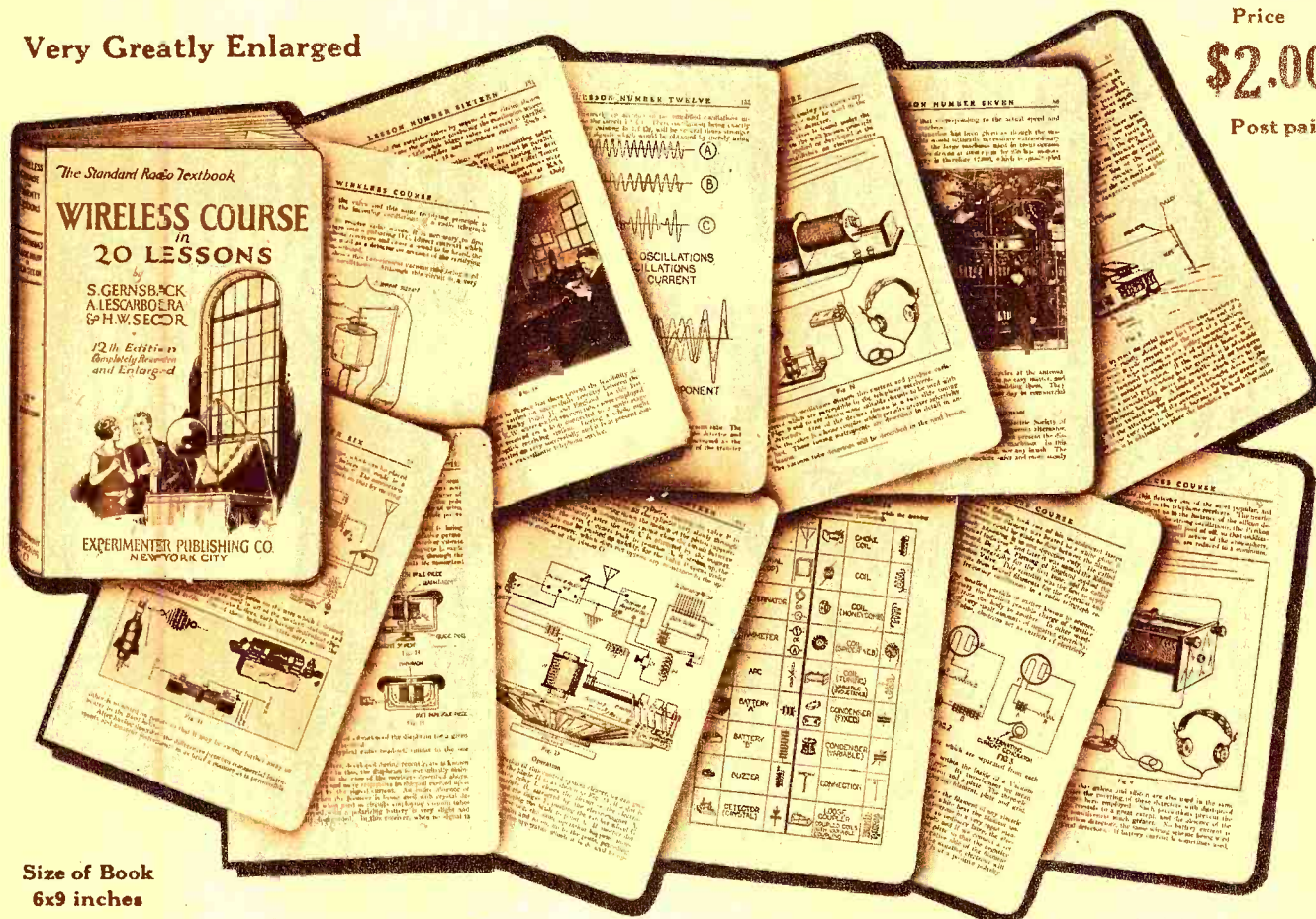

Size of Book
6x9 inches

264 pages. 500 illustrations, diagrams and photographs. Binding de luxe; black leatherette cover, genuine gold stamped; red edges; round corners; semi-flexible covers; multi-colored jackets.

This new edition contains over 100 pages more than the previous editions, of which over 100,000 were sold. It is printed in a larger type, on better paper and has better and more illustrations.

- Lesson No. 1: Principles of Electricity: History and Explanation of Electricity, etc.
- Lesson No. 2: Principles of Magnetism: The History and Explanation of Magnetism, etc.
- Lesson No. 3: Dynamos, Motors, Generators, and Wiring: Explanation of Construction and Operation of each of the above, etc.
- Lesson No. 4: Principles of Wireless Telegraphy: History and Explanation of the Wave Transmission and those concerned in the development of early radio, etc.
- Lesson No. 5: Amateur Transmitting Sets and Apparatus: Apparatus and Circuits used by Amateurs in the early days of radio telegraphy, etc.
- Lesson No. 6: Transmitting Sets (Continued): Apparatus and Circuits of Transmitting Apparatus, etc.
- Lesson No. 7: Commercial Transmitting Systems: Apparatus and their operation, etc.
- Lesson No. 8: Aerials and Underwriters Installing Regulations: Explanation of the Antenna System and Constructional details of the various types used. Official regulations, etc.

- Lesson No. 9: Radio Receiving Apparatus: Description of the Various Types of Receiving Apparatus with an explanation of their operation, etc.
- Lesson No. 10: The Detector: An explanation of the various types of detectors used for reception purposes, including circuits, etc.
- Lesson No. 11: The Vacuum Tube as a Detector: Principles of operation of the vacuum tubes, etc.
- Lesson No. 12: Regenerative Receiving Set: Description and explanation of various vacuum tube circuits, etc.
- Lesson No. 13: The Vacuum Tube as an Amplifier: Operation of the types of amplifiers as in conjunction with tuners. Loud Speakers, etc.
- Lesson No. 14: Practical Vacuum Tube Circuits: An explanation of various up-to-date Circuits used in Radio, etc.
- Lesson No. 15: Super-Regenerative Receiver: Operation of the Super-Regenerative Receiver, etc.
- Lesson No. 16: Vacuum Tube Transmitter: Vacuum Tube Transmission and Broadcasting Systems, etc.
- Lesson No. 17: Radio Compass—The Wavemeter—Radio Control: The Radio Compass. Principles and operation of the Wavemeter and Radio Control, etc.
- Lesson No. 18: Learning to Operate—The Codes—The Wireless Law: Methods of learning the International Code. Appendix: Detailed regulations of the wireless law, etc.
- Lesson No. 19: History of the Development of Radio: A progressive history of radio and those concerned in its progress, etc.
- Lesson No. 20: Mathematics of Wireless Telegraphy and Appendix: Formulas for the Calculation of Wave-length, Inductance, Capacity, and other measurements, etc.

Sent postpaid upon receipt of \$2.00

If your Dealer cannot supply you, order direct from us, giving Dealer's name and address

Experimenter Publishing Co., 53 Park Place, New York, N.Y.

GUARANTEED

For One Year

NEW REDUCED PRICES

\$350
Standard
Type

\$450
Tunable
Type



2000 Ohms
"RICO" Phones
Also made in large Ohmage

DUE to a very large increased production in the manufacture of our Rico head sets, we are now in position to let the public share in our greatly reduced cost.

Not only have we decreased the price on all of our phones, but we have actually made a number of improvements such as

superior tungsten steel magnets; a better head band; a heavier and better quality cord; sherardized non-rustable diaphragm; and a number of other minor improvements.

"RICO" phones are fully guaranteed and we will positively replace any part or set that becomes defective within a year.

NEW PRICES

No. 6—"Rico" standard head phones, 2000 ohms	\$3.50
No. 7—"Rico" standard head phones, 3000 ohms	4.00
No. 20—"Rico" De Luxe TUNED (adjustable) head sets, 2000 ohms	4.50
No. 30—"Rico" De Luxe TUNED (adjustable) head sets, 3000 ohms	5.50
No. 40—"Rico" De Luxe TUNED (adjustable) head sets, 4000 ohms	7.00

Dealers and Jobbers Write or Wire for Territory That Is Still Open for Proposition.

SEND NO MONEY

COUPON R.N.12

Radio Industries Corp.,
131 Duane Street, New York City.

Gentlemen:—Please send me by Parcel Post.....
"Rico" Phones..... for which I will
pay the postman the amount of.....

Name

Street

City

State

RADIO
INDUSTRIES
CORPORATION

131 Duane Street, New York City
Cable Address Ricotrade, New York

"RICO" TUNED (Adjustable) RECEIVERS

The greatest development in radio telephone receivers in a decade. Rico tuned receivers (patents allowed) are the only practical tunable receivers on the market. Each phone has a pure para rubber gasket which is compressible (see upper right illustration on opposite page) so as to move the diaphragm to and away from the pole piece. By means of this arrangement it is possible to achieve a super-sensitivity not possible with other phones. Rico tunable phones can be adjusted for crystal work or for three stage amplification on a tube set, at your wish.

Order from us or direct from your dealer. Fastest selling phones in America.



TO TUNE: TIGHTEN or LOOSEN CAP SLIGHTLY

"RICO" PRODUCTS

"RICO" Tuned (Adjustable)
"Melotone" Loud-Speaker



The highest grade, lowest priced, and most popular loud-speaker on the market today. This speaker is equipped with "Rico" TUNED "adjustable" loud-speaker unit. Comes fully equipped with fibre horn, heavy cast base, nickel goose neck and 5 foot cord. This low priced speaker compares well with the most expensive ones. Length of horn 11½"; total height 9".
No. 250 Melotone Loud-speaker \$6.00

"RICO"
Double Phonodapter



Double
Phonodapter
75c

"RICO" Fibre Horn
Loud-Speaker

Complete
\$10.50

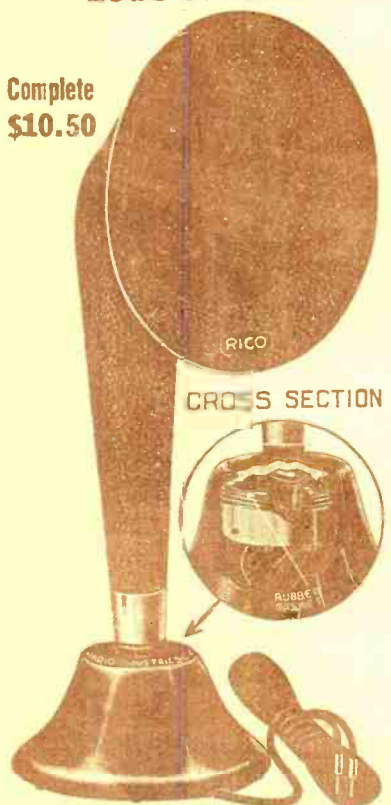

Our highest grade loud-speaker. Horn made of heavy fibre and substantially built. Height 23"; 10" bell. Equipped with No. 25 tuned loud-speaker phone. A wonderful speaker! A wonderful value!
No. 115 Loud-speaker, complete \$10.50

"RICO" Tuned (Adjustable)
Loud-Speaker Phone



This is the famous "adjustable" loud-speaker phone. A twist of the wrist adjusts sound from low to high. No rattle is possible. Maximum volume. Illustration full size.
No. 25 Loud-speaker phone \$3.50

RICO

GOODS
ARE
GOOD
GOODS
BACKED
BY

RICO

Guarantee

CAPACITY EQUALS
43 PLATE
CONDENSER



THE "RICO" STRAIGHT LINE
CONDENSER

This condenser marks a revolution in condenser building. It is the simplest and most practical type of condenser as yet developed for broadcast and amateur work. This condenser has been developed by our engineers after considerable research work and has been pronounced perfect by experts.

SOME OF THE OUTSTANDING POINTS:

- 1—Large capacity (.001 Mf.)
- 2—Replaces a 43-plate condenser.
- 3—Uses a minimum of space, size 3½" x 2½" x 1¾".
- 4—For panel mounting or for table mounting—universal in its scope.
- 5—One complete revolution of dial adjusts condenser from minimum to maximum.
- 6—Vernier effect.
- 7—Absolute straight line curve.
- 8—Accumulates no dust between plates as is the case with air condensers entirely enclosed.
- 9—Light weight. Condenser only weighs 3 oz.
- 10—Less than 1-10th amount of parts as used in old style mesh plate condenser.
- 11—Can never get out of order.
- 12—Impossible to short circuit.
- 13—Works in any position, vertical or horizontal. No counterweights needed.
- 14—Lowest in price for high class condenser.
- 15—Compactness. Size only 3½" x 2½" x 1¾" over all.

The Rico Straight Line Condenser must be seen to be appreciated. Made of the best materials that money can buy. Stands in a class by itself. All metal parts finished in nickel plate.

We will refund your money if this condenser is not all we claim for it.

No. 450 "Rico" Straight Line Condenser complete with moulded dial \$1.75
No. 451 the same condenser but without dial (what is for ¼ inch) \$1.50

"RICO"
Single Phonodapter

50c

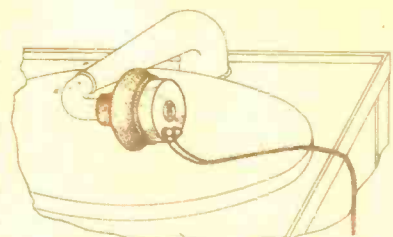

"Rico" PHONODAPTER fits any standard phonograph

This adapter fits Columbia, Victor and Sonora phonographs. Is made entirely of pure rubber with brass tube insert.

Kindly study our illustration carefully, you will find that the "RICO" Phonodapter presents many unique advantages over other similar adapters. In the first place, the entire adapter is made of pure rubber and will stretch over any make of phone. It has, however, been especially developed for the "RICO" Loud Speaker Phone.

RADIO
INDUSTRIES
CORPORATION

131 Duane Street, New York City

Cable Address: Ricotrade, New York.

SEND NO MONEY

COUPON R.N. 12

Radio Industries Corp.,
131 Duane Street, New York City.

Gentlemen:—Please send me by Parcel Post,.....
"Rico"..... for which I will
pay the postman the amount of.....

Name

Street

City

State

Look for the Gold Cover!

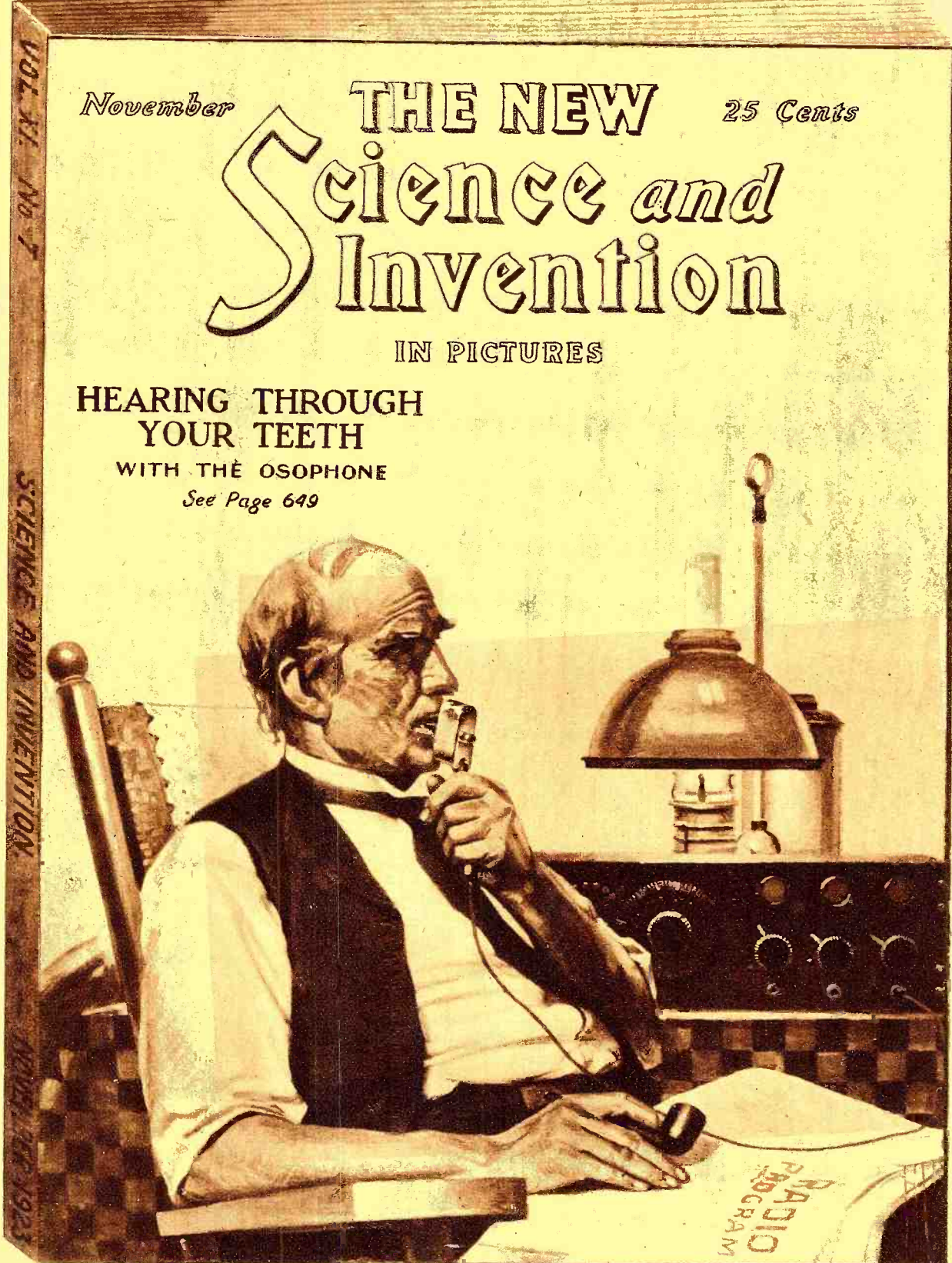

The **NEW SCIENCE** and **INVENTION**.

On All Newsstands November 20th

SOMETHING ENTIRELY NEW!

A scientific magazine without text—only illustrations and short captions. Every issue creates a sensation. This is the first scientific magazine ever printed with pictures and captions only. Order from your dealer now, otherwise you will surely be disappointed in not getting your copy. **LOOK FOR THE GOLD COVER!**

Over Twice As Much Radio As Ever Before

INCIDENTALLY, SCIENCE AND INVENTION will appear in a new make-up which will make its reading far more fascinating and interesting than it has ever been in the past.

25c A Copy - - \$2.50 Per Year

EXPERIMENTER PUBLISHING CO.

53 PARK PLACE, NEW YORK

Radio Poems

A NEOPHYTE'S EXPERIENCE

I started out with radio right, you bet,
Took the book's advice, got a crystal set.
Connected it here and stuck a wire there
And hoisted another one high in the air,
But my friends laughed and said, "You
forget,"
"That ten miles is all you can hear, you
rube,
For you don't know the code yet by ear, you
boob,
Get a set of the hour, one right up-to-date
Sixty horsepower with a loop in the plate
Circuit, you know, vacuum tube."
So I innocently took my friends' advice
And I bought me a set, the "Super-Nice."
The tubes burned out, the batteries went
dead
It wouldn't work, but my cheerful friends
said,
"Don't give up, you'll learn in a trice."
But my most earnest efforts were in vain
From howling it would not abstain.
I wiggled the tickler till it gave me the itch
And shorted the condenser on its phase-
angle-pitch.
That set really gave me a pain.
So I wrecked the cursed thing with one
mighty slash.
Then I studied and learned the darn code;
I was rash.
Now each night, with delight, I listen-in and
enjoy
With my first love, my old crystal set, and,
O Boy!
How I love the du da da da dash!

Contributed by James S. Hearst.

TO MY PHONOGRAPH

If I was a bit revengeful—I could land on
ye hard today—
Settin' here in yer corner—with not very
much to say,—
Ain't been half of a coon's age—sence you
was the O'ry Star—
Till—in steps the family Radio,—an' now—
look where ye are!
I recollect how ye soaked us—on prices of
simple song—
Socked on the tariff an' war-tax,—an' levied
'em good an' strong—
Looked mighty over-bearin' in yer polished
mahogany case—
Till—in stepped the family Radio,—an' golly
—look at yer face!
Ain't been the half of a coon's age—sence ye
had the world by the tail—
Cost half as much as my flivver—with never
a bargain-sale,—
Sung to the keeful buyer—in terms of a
hoss or cow—
Countin' on vaultin' higher, but—what's yer
opinion now?
There's powerful searchin' lesson—in yer
meteoric career —
Kep' all the world a-guessin' on where ye
would go from here.—
So longed fer—an' so demanded—so lovin'ly
talked about—
Don't it hurt—to be second-handed,—with
the bottom a-drappin' out?

Uncle John.

A RADIO SONG

Yes! We Have No Coherers
Yes! We have no coherers,
We have no coherers today.
We have "supers," reflexes,
And Weagen: "X"s,
And all sorts of hook-ups so great.
We had the old-fashioned magnetic,
The older electrolytic.
Yes! We have no coherers,
But we've static in the same old way.
With apologies to the original author.
Contributed by Henry Kaufmann.

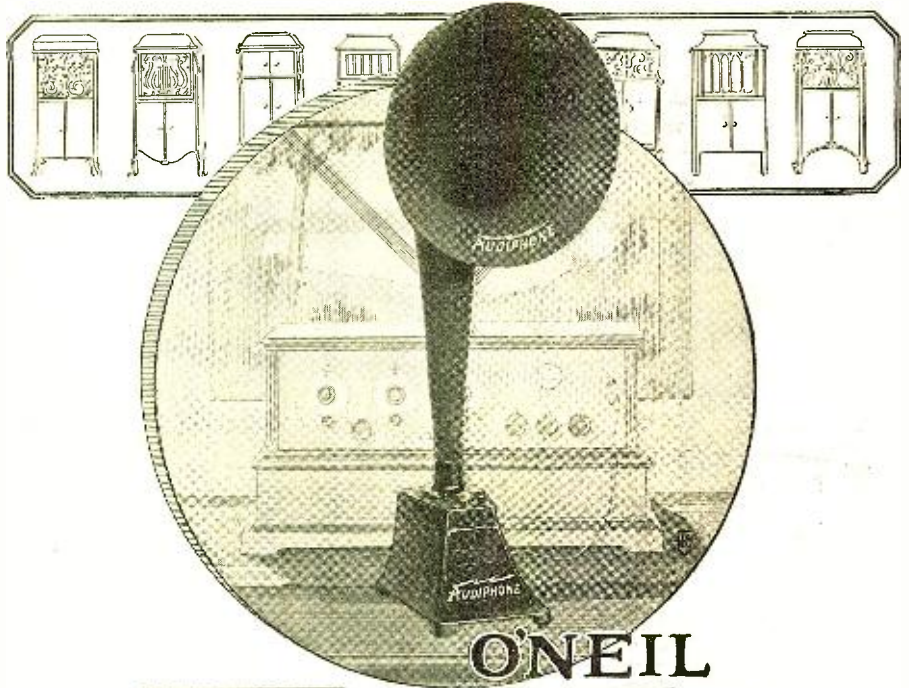

O'NEIL AUDIPHONE

Knowledge stored up during many years of phonograph reproduction and electro acoustic experience now released to the radio world through the AUDIPHONE.

"NO radio receiver is better than its reproducer—the loud speaker." The AUDIPHONE puts the human touch into the electrical elements of your receiver. Sturdy loud speaker construction with strong magnetic field absolutely eliminates blast and distortion so prevalent in ear-phone types of loud speakers. Programs created anew in your home exactly as broadcasted from the radio studios. The patented, External adjusting feature enables you to regulate the AUDIPHONE to your individual receiving conditions. Startlingly r-e-a-l amplification without extra batteries, transformer or induction coil. Write for illustrated booklet and send us the name of your dealer.

Complete
with 5 foot
phone cord.

PRICE

\$25

Dealers, Jobbers, and Distributors:
Write for attractive proposition.

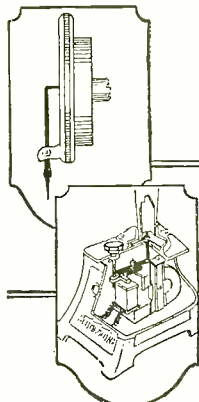

Note the similarity of construction between the phonograph reproducer (illustrated in the upper panel) and the reproducer of the O'Neil AUDIPHONE (below): both have a mica diaphragm set in a sound-box chamber and actuated by an elbow stylus bar—the principle of sound production is the same, resulting in perfect reproduction.

O'Neil Mfg. Co.

719 Palisade Ave., West New York, N. J.

Tube Efficiency Is Trebled With Erla Synchronizing Transformers

Vacuum tube acting as relay or single-duty amplifier



Vacuum tube doing double duty as amplifier of received and reflexed r. f. currents, with Erla synchronizing radio transformer



Vacuum tube doing triple duty as amplifier of reflexed audio as well as received and reflexed radio frequency currents, with Erla synchronizing radio and audio transformers

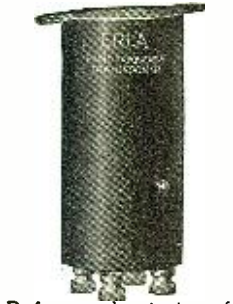

Perfect synchronization of received and reflexed r. f. currents make Erla radio transformers indispensable in reflex work. List, \$5



Rectified radio frequency and reflexed audio frequency currents are accurately synchronized by Erla audio transformers. List Price, \$5



Providing utmost sensitivity with perfect stability, the Erla fixed crystal rectifier is uniquely adapted for reflex work. List, \$1

Jobs—Unexampled sales opportunities are created by Erla leadership in research and manufacturing. Write for liberal terms and discounts

Responsible for the unduplicated efficiency of Erla reflex circuits is a basic Erla discovery of vital and far reaching importance.

Discordance and instability in reflex circuits, it has been ascertained, are due directly to failure of transformers properly to synchronize received and reflexed currents having the same phase characteristics, in their simultaneous passage through amplifying tubes.

Obviously, if the lag between such currents were as much as 180°, the net result of their opposing forces would be zero, resulting in an absolute canceling of signal strength. Any intermediate lag, on the other hand, results inevitably in the generation of amplified distortion.

Erla scientists solved this problem by designing radio and audio transformers of an entirely new and special type, positively assuring perfect synchronization of received and reflexed radio frequency, as well as rectified radio and reflexed audio frequency currents.

This achievement, enabling vacuum tubes successfully to do triple duty, as simultaneous amplifiers of radio frequency, reflexed radio frequency and reflexed audio frequency currents, marks one of the most important advancements of recent years.

For complete details, ask your dealer for Erla Bulletin No. 14, describing and illustrating perfected Erla one, two and three-tube reflex circuits. Or write us, giving your dealer's name.

Electrical Research Laboratories
Dept. C 2515 Michigan Ave., Chicago



ONE THOUSAND AGENTS WANTED

WE want one thousand agents to sell subscriptions to RADIO NEWS, SCIENCE & INVENTION and PRACTICAL ELECTRICS. We will pay a generous commission for this work and help you in every way. Our three publications are leaders in their fields, ready sellers and this is an offer well worth your while. A few spare hours a day will bring you a handsome return. Write regarding our proposition at once and be the first one to get started in your vicinity.

Experimenter Publishing Co.

HERBERT H. FOSTER, Sales Manager

53 Park Place

New York

receivers on the same basis and get more luck than they ever saw in their lives.

In a lumber camp I met a young mechanic with a brand new wife, Ford and life insurance policy. Such enterprising young men should have radio receivers as a sort of stabilizing element to keep wife and the car from getting too far away while they are at the mill.

There are many isolated lumber camps in Florida. Some of them, as well as many road building camps, are full of convicts. After the harrowing of the public's sympathy by last winter's revelations of brutality practiced on Florida convicts, it should not be difficult to interest charitably inclined persons in providing radio receivers for prison camps.

All these radio markets are open among the permanent residents of Florida, but like them, the radio man should perhaps look at the tourist crop as the most important. It is said that the fruit and vegetable crops, the lumber, phosphate, fish and other products, pay the expenses of Florida, private and public, and that the \$40,000,000 left there annually by the tourists represents the state's profits. The tourists are good spenders, they are there during the best radio season, and they should be led to lay down some of their cash for radio equipment. The houses on wheels that are seen trundling along every highway and resting at every auto camp lack radio equipment so far. It is about all that they do lack. The deficiency should be supplied. The tourist hotels should be equipped with radio. Some of them are, but they do not seem to be making as much of it as they might. Stock market reports, produce reports, weather forecasts and news dispatches would attract profitable trade to the hotels that got them first.

Almost everybody in Florida in the winter comes from somewhere else. All the winter visitors are glad to receive news items from home. The news broadcast by enterprising newspapers should be made as complete as possible with this in mind, and its receipt in every tourist center should be ensured by organization, for the benefit of radio as well as of the tourists.

A good demonstration of radio efficiency in Florida in the tourist season would reach as many of the most influential people as demonstrations in the other forty-seven states.

Complete List of Broadcasting Stations

(Continued from page 728)

Call	Location	Wave-length in meters
WCAK	Houston, Texas	360
WCAL	Northfield, Minn.	360
WCAM	Villanova, Pa.	380
WCAO	Baltimore, Md.	360
WCAP	Washington, D. C.	469
WCAR	San Antonio, Texas	360
WCAS	Minneapolis, Minn.	246
WCAT	Rapid City, S. D.	240
WCAU	Philadelphia, Pa.	286
WCAV	Little Rock, Ark.	360
WCAX	Burlington, Vt.	360
WCAY	Milwaukee, Wis.	261
WQBA	Allentown, Pa.	280
WCBB	Greenville, Ohio	240
WCBD	Zion, Ill.	345
WCE	Minneapolis, Minn.	360
WCK	St. Louis, Mo.	360
WCM	Austin, Texas	360
WCX	Detroit, Mich.	517
WDAD	Lindsburg, Kan.	360
WDAE	Tampa, Fla.	360
WDAF	Kansas City, Mo.	411
WDAG	Amarillo, Texas	263
WDAH	El Paso, Texas	268
WDAI	El Paso, Texas	360
WDAJ	Syracuse, N. Y.	246
WDAK	College Park, Ga.	258
WDAK	Hartford, Conn.	269
WDAI	Jacksonville, Fla.	360
WDAO	Dallas, Texas	360
WDAP	Chicago, Ill.	360

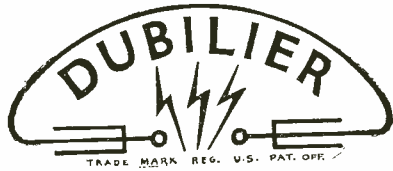

The name DUBILIER a guarantee in itself—

Although all Dubilier products are guaranteed, the name Dubilier on a Micadon, Variadon, Duratran or Ducon, is in itself a sufficient protection.

The name Dubilier stands for the highest standards in design and manufacturing.

Dubilier devices are patented, and the specific features that make them superior are found only in them.



The Dubilier Ducon
(socket plug)

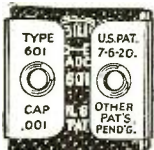

Dubilier Micadons
(fixed condensers)



The Dubilier Duratran
(radio frequency-
transformer)



The Dubilier Variadon
(variable mica con-
denser)

Dubilier Condenser & Radio Corp.
48-50 West Fourth Street, New York

DUBILIER DEVICES

PEERLESS and DAVIS

Double Headphones

Test them against other good makes that cost twice as much.

This test will clearly prove why Peerless and Davis quality headsets are the biggest sellers in their field.

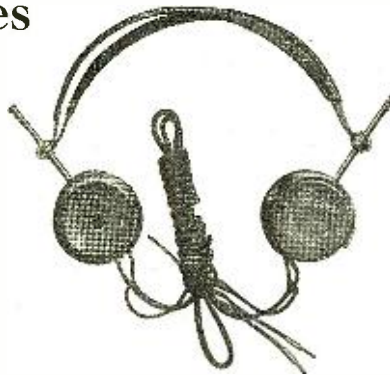

PEERLESS

Universal Range Double Tuning Coil

150-550 Meters

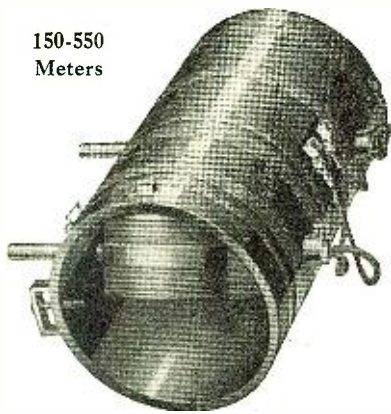

A Complete Tuning Coil.
Three fine instruments in one.
Takes the place of
Variometer
Variocoupler
Variable Condenser
at one-third their cost.

Ask Your Dealer

United Radio Corpn.
Rochester, N. Y.

Export Office: 50 Church St., New York



MARKO "A" BATTERY

90 AMP. HRS.

IN RUBBERLITH CASE

Highly Ornamental As Well As Efficient

The Rubberlith case is a composition case with a high gloss giving the appearance of ebony. It is moulded in one piece, including handles and cells—no jars to break—and is practically indestructible. A worthy addition to your set.

ALL SIZES, FROM 2 VOLT BATTERIES UP, CARRIED IN MAHOGANY FINISH CASES

SOLD BY

MANHATTAN ELECTRICAL SUPPLY CO., 17 Park Place, New York, N. Y.
STANLEY & PATTERSON, 23 Murray St., New York, N. Y.
J. H. BUNNELL & CO., 32 Park Place, New York, N. Y.
PACENT ELECTRIC CO., 22 Park Place, New York, N. Y.

ALSO RADIO SUPPLY STORES AND ALL MARKO SERVICE STATIONS

MADE BY

MARKO STORAGE BATTERY CO.

1402 ATLANTIC AVENUE, BROOKLYN, N. Y.

Branch, Jefferson at Bedford Ave., Brooklyn, N. Y.

210 W. 54th St., New York, N. Y.

RHAMSTINE*

The Rhamstine* Victophone replaces the reproducer on your phonograph and transforms it into an ideal loud-speaker. Post paid **\$7.50**

J. THOS. RHAMSTINE*

500 Woodbridge E. Detroit, Mich.
*Maker of Radio Products

"MASTER" Radio Products

Manufactured by Radio Division of
UNION CONSTRUCTION COMPANY

Oakland, California

Choice Jobbing Territory Still Open.
Write for particulars

Call	Location	Wave-length in meters
WDAR	Philadelphia, Pa.	395
WDAS	Worcester, Mass.	360
WDAU	New Bedford, Mass.	360
WDAX	Centerville, Iowa	268
WDAY	Fargo, N. D.	244
WDDB	Lancaster, Pa.	258
WDBF	Youngstown, Ohio	261
WDM	Washington, D. C.	360
WDT	New York City, N. Y.	405
WDZ	Tuscola, Ill.	278
WEAA	Flint, Mich.	280
WEAB	Fort Dodge, Iowa	360
WEAE	Blacksburg, Va.	360
WBAF	Morrestown, N. J.	360
WEAG	Edgewood, R. I.	231
WEAH	Wichita, Kan.	244
WEAI	Ithica, N. Y.	286
WEAK	St. Joseph, Mo.	360
WEAJ	Vermilion, S. D.	360
WEAM	North Plainfield, N. J.	252
WEAN	Providence, R. I.	272
WEAO	Columbus, Ohio	360
WEAR	Baltimore, Md.	360
WEAS	Washington, D. C.	360
WEAU	Sioux City, Iowa	360
WEAY	Houston, Texas	360
WEB	St. Louis, Mo.	360
WEV	Houston, Texas	360
WEW	St. Louis, Mo.	261
WFAB	Dallas, Texas	476
WFAB	Syracuse, N. Y.	234
WFAF	Poughkeepsie, N. Y.	273
WFAG	Cameron, Mo.	360
WFAH	Port Arthur, Texas	360
WFAJ	Ashville, N. C.	360
WFAM	St. Cloud, Minn.	360
WFAN	Hutchinson, Minn.	360
WFAT	Sioux Falls, S. D.	360
WFAV	Lincoln, Neb.	360
WFI	Philadelphia, Pa.	395
WGAJ	Tulsa, Okla.	360
WGAF	Pensacola, Fla.	360
WGAG	Shreveport, La.	360
WGAR	Fort Smith, Ark.	360
WGAU	Wooster, Ohio	226
WGAW	Altoona, Pa.	261
WGAY	Madison, Wis.	360
WGAZ	South Bend, Ind.	360
WGF	Des Moines, Iowa	360
WGI	Medford Hillside, Mass.	360
WGL	Philadelphia, Pa.	360
WGR	Buffalo, N. Y.	319
WGV	New Orleans, La.	350
WGY	Schenectady, N. Y.	380
WHA	Madison, Wis.	360
WHAA	Iowa City, Iowa	283
WHAB	Galveston, Tex.	360
WHAD	Milwaukee, Wis.	280
WHAG	Cincinnati, O.	222
WHAH	Joplin, Mo.	360
WHAK	Clarksburg, W. Va.	360
WHAL	Lansing, Mich.	248
WHAM	Rochester, N. Y.	360
WHAO	Savannah, Ga.	360
WHAP	Decatur, Ill.	360
WHAQ	Washington, D. C.	242
WHAR	Atlantic City, N. J.	231
WHAS	Louisville, Ky.	400
WHAV	Wilmington, Del.	360
WHAY	Huntington, Ind.	360
WHAZ	Troy, N. Y.	380
WHB	Kansas City, Mo.	411
WHD	Morgantown, W. Va.	360
WHK	Cleveland, O.	360
WHN	Loew's State Theatre, New York	360
WIAB	Rockford, Ill.	360
WIAC	Galveston, Tex.	360
WIAD	Ocean City, N. J.	254
WIAF	New Orleans, La.	234
WIAH	Newton, Iowa	360
WIAI	Springfield, Mo.	253
WIAJ	Neenah, Wis.	360
WIAK	Omaha, Neb.	278
WIAO	Milwaukee, Wis.	360
WIAQ	Marion, Ind.	226
WIAS	Burlington, Iowa	360
WIAU	Le Mars, Iowa	360
WIAY	Washington, D. C.	224
WIK	McKeesport, Pa.	360
WIL	Washington, D. C.	360
WIP	Philadelphia, Pa.	509
WJAB	Lincoln, Nebr.	360
WJAD	Waco, Tex.	360
WJAF	Muncie, Ind.	390
WJAG	Norfolk, Neb.	360
WJAM	Cedar Rapids, Iowa	268
WJAN	Peoria, Ill.	280
WJAO	Topeka, Kan.	360
WJAR	Providence, R. I.	360
WJAS	Pittsburgh, Pa.	360
WJAT	Marshall, Mo.	360
WJAX	Cleveland, O.	390
WJAZ	Chicago, Ill.	448
WJD	Granville, O.	229
WJH	Washington, D. C.	263
WJX	New York, N. Y.	360
WJY	New York, N. Y.	405
WJZ	New York, N. Y.	455
WKAA	Cedar Rapids, Iowa	360
WKAC	Lincoln, Neb.	275
WKAD	East Providence, R. I.	240
WKAF	Wichita Falls, Texas	360
WKAN	Montgomery, Ala.	226
WKAP	Grandston, R. I.	360
WKAQ	San Juan, Porto Rico	360
WKAR	East Lansing, Mich.	280
WKAS	Springfield, Mo.	360
WKAV	Laconia, N. H.	254

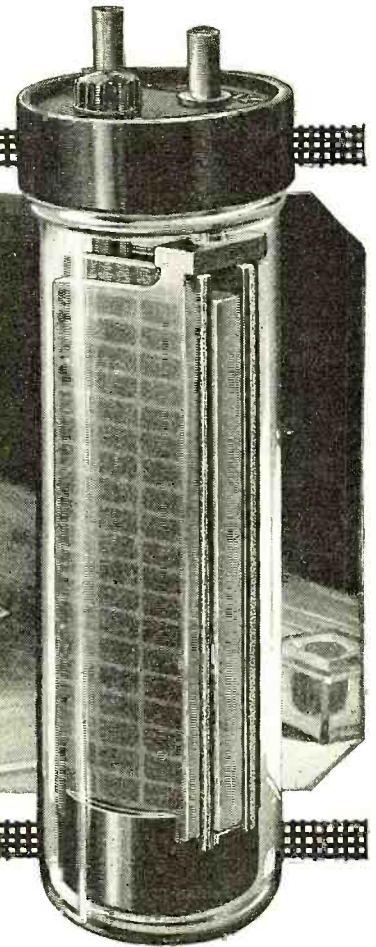

A Peanut Tube Battery that Lasts for Years

Do you want a better battery for your peanut tube set—a battery which needs only recharging to keep it working always at top-notch efficiency—and which cuts out noise in your 'phones?

Then you want the new Willard CTR Rechargeable Radio Battery—the latest Willard Radio Battery achievement.

This new Willard Radio Battery is the farthest advance in peanut tube battery development. It provides all the many advantages of the right kind of storage battery at a surprisingly low cost.

With WD-11 or WD-12 tubes you need one CTR cell for each tube. This will give you a far greater capacity than the ordinary battery. If you use UV-199 or

C-299 tubes, two CTR cells will replace three ordinary batteries and give you five times the capacity.

A Willard CTR Battery and a Willard Colloid Rectifier for charging it make a combination that insures satisfactory battery performance at all times. You can buy a Willard Rectifier for only \$2.00.

Willard CTR Batteries are shipped to dealers bone-dry, yet full charged. They do not deteriorate. The solution is added when purchased, you receive a fresh, fully charged battery ready for immediate use.

Sold by Willard Service Stations and Radio Dealers everywhere. Ask your dealer for the free booklet describing it, or write the Willard Storage Battery Company, Cleveland, Ohio.

A

Good A Batteries are as important as good B Batteries. There are several types of Willard A Batteries at a range of prices, including the Willard All-Rubber A Battery, with rubber case and Threaded Rubber Insulation. Five sizes, 20 to 125 a. h.



Willard Rechargeable Batteries for Radio



B

Willard Rechargeable B Batteries are made in 24 volt or 48 volt units, each type in two capacities, 2500 and 4500 m. a. h. Glass jars enable you to see the condition of your battery at all times and help prevent electrical leakage.

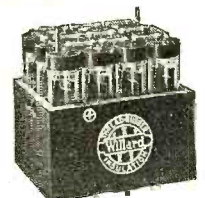

ACOUSTICALLY CORRECT!

The Trimm extra large Loud Speaker unit with its wonderful ADJUSTO instantly regulating loud speaker to signal strength insures greatest volume without flaws or distortion. At three prices:



ACOUSTICOLA STANDARD MODEL
with non-metallic horn, 21½" high; bell, 10" diam. **\$2250**

ACOUSTICOLA GRAND
With solid Cast Aluminum Horn; the world's finest loud speaker. **\$3500**

ACOUSTICOLA PHONOGRAPH ATTACHMENT \$1000

TRIMM HIGH GRADE HEADSETS

"Professional" model—3000 ohms **\$765**

"Dependable" model—2400 ohms **\$500**

Any Trimm product shipped and sold on approval and Guaranteed FOR LIFE. Write for descriptive folders. Mention your dealer's name.

TRIMM RADIO MANUFACTURING CO.

DEPT. 55
24-30 S. CLINTON STREET :: :: CHICAGO, ILL.



BUY PARTS THAT FIT ANY HOOKUP

Quickly - economically - least labor

The R.P.M. Units are complete in themselves. All wires are concealed. Connections made to binding posts—simply and quickly—each unit can be moved into any position in a circuit by simply changing the binding post connections.



The units are made of Bakelite, moulded in our own factory.

For building your own set no other means is half as handy or economical. Start with a tuner and detector unit and add amplifiers as experience and your pocketbook permits.

The units are made up of the following instruments: Variometer, Variocoupler, Coupled Circuit Tuner (both mounted and unmounted models), Detector Unit, Amplifying Units and Micrometer Variable Condenser Unit.

Illustrated folder and prices on request. Your dealer will be glad to show you these units or write us.

Radio Products Mfg. Co.
667 West 14th St. Chicago, Ill.

199 NECESSITIES

WIMCO 199 SOCKET \$.75
WIMCO 199 C SOCKET 1.00
WIMCO 199 ADAPTER75

Send for free literature. Jobbers' inquiries solicited.

THE WIRELESS MFG. CO., Canton, Ohio
MANUFACTURERS—DISTRIBUTORS

VULCANIZED FIBRE Be sure and specify "WILMINGTON FIBRE"

Sheets, Rods, Tubes, Washers, Etc., Specialties

Wilmington Fibre Specialty Co., Wilmington, Del.
Branch Offices "Everywhere"

Call	Location	Wave-length in meters
WKAW	Beloit, Wis.	246
WKAX	Bridgeport, Conn.	231
WKAY	Gainesville, Ga.	360
WKC	Baltimore, Md.	360
WKY	Oklahoma City, Okla.	360
WL2	Fairfield, Ohio	360
WLAC	Raleigh, N. C.	360
WLAG	Minneapolis, Minn.	417
WLAH	Syracuse, N. Y.	234
WLAJ	Waco, Texas	360
WLAK	Bellows Falls, Vt.	369
WLAN	Houlton, Me.	283
WLAP	Louisville, Ky.	360
WLAQ	Kalamazoo, Mich.	244
WLAT	Burlington, Iowa	360
WLAV	Pensacola, Fla.	360
WLAW	New York, N. Y.	360
WLAX	Greencastle, Ind.	231
WLAZ	Warren, Ohio	248
WLW	Cincinnati, Ohio	309
WMAC	Cazenovia, N. Y.	261
WMAF	Dartmouth, Mass.	360
WMAH	Lincoln, Neb.	254
WMAJ	Kansas City, Mo.	275
WMAK	Lockport, N. Y.	360
WMAL	Trenton, N. J.	256
WMAM	Beaumont, Texas	360
WMAP	Easton, Pa.	246
WMAQ	Chicago, Ill.	447
WMAT	Duluth, Minn.	266
WMAV	Auburn, Ala.	250
WMAZ	St. Louis, Mo.	280
WMAZ	Macon, Ga.	268
WMC	Memphis, Tenn.	500
WMH	Cincinnati, Ohio	248
WMS	Albany, N. Y.	360
WMU	Washington, D. C.	261
WNAC	Boston, Mass.	278
WNAD	Norman, Okla.	360
WNAL	Omaha, Neb.	242
WNAN	Syracuse, N. Y.	286
WNAP	Springfield, Ohio	360
WNAQ	Charleston, S. C.	360
WNAR	Butler, Mo.	360
WNAS	Austin, Texas	360
WNAT	Philadelphia, Pa.	360
WNAV	Knoxville, Tenn.	360
WNAW	Fortress Monroe, Va.	360
WNAX	Yankton, S. D.	244
WNAZ	Baltimore, Md.	360
WNJ	Albany, N. Y.	360
WOAA	Ardmore, Okla.	360
WOAB	Grand Forks, N. D.	280
WOAC	Lima, Ohio	266
WOAD	Sigourney, Iowa	360
WOAE	Fremont, Neb.	360
WOAF	Tyler, Texas	360
WOAG	Belvidere, Ill.	224
WOAH	Charleston, S. C.	360
WOAI	San Antonio, Texas	385
WOAI	Parsons, Kan.	258
WOAK	Frankfort, Ky.	240
WOAL	Webster Groves, Mo.	360
WOAN	Lawrenceburg, Tenn.	360
WOAO	Mishawaka, Ind.	360
WOAP	Kalamazoo, Mich.	360
WOAQ	Portsmouth, Va.	360
WOAR	Kenosha, Wis.	360
WOAT	Wilmington, Del.	360
WOAV	Erie, Pa.	242
WOAW	Omaha, Neb.	526
WOAX	Trenton, N. J.	240
WOAZ	Stanford, Texas	360
WOC	Davenport, Iowa	484
WOI	Ames, Iowa	360
WOK	Pine Bluff, Ark.	360
WOO	Philadelphia, Pa.	509
WOQ	Kansas City, Mo.	360
WOR	Newark, N. J.	405
WOS	Jefferson City, Mo.	441
WPAB	State College, Pa.	360
WPAC	Okmulgee, Okla.	360
WPAD	Chicago, Ill.	360
WPAF	Council Bluffs, Iowa	360
WPAG	Independence, Mo.	360
WPAH	Waupaca, Wis.	360
WPAI	New Haven, Conn.	268
WPAK	Fargo, N. D.	360
WPAL	Columbus, Ohio	286
WPAM	Topeka, Kan.	360
WPAP	Winchester, Ky.	360
WPAQ	Frostburg, Md.	360
WPAR	Beloit, Kan.	360
WPAT	El Paso, Texas	360
WPAU	Moorhead, Minn.	360
WPAX	Thomasville, Ga.	360
WPAZ	Charleston, W. Va.	273
WPG	New Lebanon, Ohio	360
WQAA	Parkersburg, Pa.	360
WQAB	Springfield, Mo.	236
WQAC	Amarillo, Texas	360
WQAD	Waterbury, Conn.	242
WQAE	Springfield, Vt.	275
WQAF	Sandusky, Ohio	240
WQAH	Lexington, Ky.	254
WQAL	Mattoon, Ill.	258
WQAM	Miami, Fla.	360
WQAN	Scranton, Pa.	280
WQAO	New York, N. Y.	360
WQAP	Lincoln, Neb.	360
WQAO	Abilene, Texas	360
WQAS	Lowell, Mass.	266
WQAV	Greenville, S. C.	258
WQAW	Washington, D. C.	236
WQAX	Peoria, Ill.	360
WQAZ	Greensboro, N. C.	360



Closed Circuit Jack
Price 85 cents

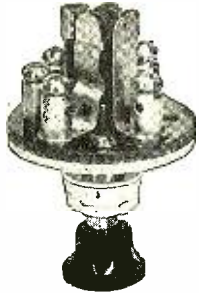

Detector Amplifier Switch
Price \$1.50



Single Pole Double Throw Switch
Price \$1.25



Double Filament Control Jack
Price \$1.25



Series Parallel Switch
Price \$1.50



Improved "A" Battery Switch
Price \$1.00



JOSEPH W. JONES

One of America's leading inventors, and who has been granted over 300 patents.

Inventor of the method now used for making Disc Phonograph records.

Inventor of the pioneer Speedometer and the Best, The Jones. Inventor of the Jones Victometer, or Aeroplane Tachometer, used by the U. S. Army and Navy.

Inventor of the Jones Motrola, which eliminates the need of phonograph winding.

Inventor of the Jones Electric Drill.

JOS. W. JONES
RADIO
TRADE MARK

Invented These

IMPROVED
ANTI-CAPACITY

Radio Jacks and Switches To Save Your Time and Money

HERE is a line of radio jacks and switches radically different in design and construction from any similar product. They are *not* telephone fittings modified for radio use, but are designed especially to meet the exacting requirements of the radio enthusiast who knows what he wants.

They save drilling and soldering—give you better results by eliminating capacity effects—give you a neater set, because they eliminate contact points on front of panel—they save your time, temper and money.

Most radio dealers have these little round jacks and switches with the red button. If yours hasn't, send us his name and ask for folder describing the entire line.

RADIO IMPROVEMENT CO., Inc.
29 WEST 35th STREET NEW YORK

DISTRIBUTED BY

Triangle Radio Supply Co.New York City
Wholesale Radio Equip. Co.Newark, N. J.
W. T. Grant StoresAll large cities
General Radio CorporationPhila., Pa.
Rumsey Electric CompanyPhiladelphia
James H. Jones CompanyBoston
C. S. Tay Sales Co.Chicago, Ill.
Avery & Loeb Electric Co.Columbus, Ohio
Wright & Wilhemy CompanyOmaha, Neb.
Robertson Cataract Elec. Co.Rochester, N. Y.
Charles Goldfus Co.Minneapolis, Minn.
Ludwig-Hommel & CompanyPittsburgh, Penn.
Radio Sales CompanyPittsburgh, Penn.
Electric Supply Co.Memphis, Tenn.
Heard CompanySt. Louis, Mo.

Havens Electric Co.Albany, N. Y.
H. F. Sackett Electric Co.Buffalo, N. Y.
McCarthy Bros. & FordBuffalo, N. Y.
Newman-Stern Co., Inc.Cleveland, O.
Radio Engineering & Sales Co.Cleveland, O.
M & M CompanyCleveland, O.
H. C. TafelLouisville, Ky.
American Radio Mfg. Co.Kansas City, Mo.
Detroit Electric Co.Detroit, Mich.
Stern & Co.Hartford, Conn.
Blish, Mize & Stillman Hdwe. Co., Atchison, Kansas
Comers Electric StoreHutchinson, Kansas
Milnor Elec. CompanyCincinnati, Ohio
Joplin Radio Co.Joplin, Mo.
W. A. L. Thompson Hdwe. Co.Topeka, Kan.
The Varney Electric Supply Co., Indianapolis, Ind.



Grid Leak
Price \$1.50



Double Circuit Jack
Price \$1.00



Inductance Switch
Price \$1.50



Double Pole Double Throw Switch
Price \$1.60



Open Circuit
Price 70 cents



Single Filament Control Jack
Price \$1.00

World BATTERIES

Buy Quality at Rock-Bottom Prices!



Save you 50%

Written 2 Year Guarantee Your Proof of "Worlds of Performance"

Concessions on tremendous purchases for our enormous production makes it possible for us to again slash battery prices. Thousands of RADIO NEWS readers will profit by these prices. But they will have to act quickly. Everyone knows the costs of materials are rising. Order today!

The World's Best Storage Battery at a tremendous saving

No better battery than the "World" can be built. That is why we can back it with the strongest guarantee written. We maintain the quality of our product. Our batteries have to be "right." And they are "right." Our tremendous steady increase in sales prove it. World Battery Owners "Tell Their Friends." This is our best proof of performance.

Compare These Prices

Special 2 Volt Storage Battery.....\$5.00 For WD11 and WY12 tubes. Will run 200 hours on one charge. Rechargeable. Special 4 Volt Storage Battery.....\$8.00 For UV199 tubes. Same features as 2 Volt.	6 Volt, 60 Amp.\$ 8.50 6 Volt, 80 Amp. 10.00 6 Volt, 100 Amp. 12.50 6 Volt, 120 Amp. 14.50 6 Volt, 140 Amp. 16.00
---	--

Send No Money

You need not send a penny. Just your name and address. We ship C.O.D. subject to inspection or will allow 5 percent discount for cash with order. When the battery arrives C.O.D. read the 2-year written guarantee before you pay one penny. You are protected with our guarantee from every angle. Save 50 percent by acting while these prices hold.

WORLD BATTERY CO., Dept. 10,
1219 So. Wabash Avenue, Chicago, Ill.

ORDER

The above prices are the lowest in World Battery history and are in keeping with our policy of "Greater Value for Less Money." Take advantage of them NOW!

NOW!

Call	Location	Wave-length in meters
WRAA	Houston, Texas	360
WRAB	Savannah, Ga.	360
WRAD	Marion, Kan.	248
WRAF	La Porte, Ind.	224
WRAH	Providence, R. I.	360
WRAL	St. Croix Falls, Wis.	248
WRAO	St. Louis, Mo.	360
WRAP	Winterpark	360
WRAR	David City, Neb.	226
WRAS	McLeansboro, Ill.	360
WRAU	Amarillo, Texas	360
WRAV	Yellow Spring, Ohio	360
WRAV	Reading, Pa.	238
WRAX	Gloucester City, N. J.	268
WRAY	Scranton, Pa.	280
WRAZ	Newark, N. J.	233
WRC	Washington, D. C.	469
WRK	Hamilton, Ohio	360
WRL	Schenectady, N. Y.	360
WRM	Urbana, Ill.	360
WRR	Dallas, Texas	360
WRW	Tarrytown, N. Y.	273
WSAB	Cape Girardeau, Mo.	360
WSAC	Clemson College, S. C.	360
WSAD	Providence, R. I.	261
WSAG	St. Petersburg, Fla.	244
WSAH	Chicago, Ill.	248
WSAI	Cincinnati, Ohio	300
WSAJ	Grove City, Pa.	360
WSAK	Middleport, Ohio	258
WSAL	Brookville, Ind.	246
WSAN	Allentown, Pa.	229
WSAP	New York, N. Y.	263
WSAR	Fall River, Mass.	254
WSAT	Plainview, Texas	268
WSAU	Chesham, N. H.	229
WSAW	Canadaigua, N. Y.	275
WSAX	Chicago, Ill.	268
WSB	Atlanta, Ga.	429
WSL	Utica, N. Y.	273
WSN	Norfolk, Va.	360
WSY	Birmingham, Ala.	360
WTAB	Fall River, Mass.	248
WTAC	Johnstown, Pa.	360
WTAD	Carthage, Ill.	229
WTAF	New Orleans, La.	242
WTAG	Providence, R. I.	258
WTAH	Belvidere, Ill.	236
WTAJ	Portland, Me.	236
WTAK	Steubenville, Ohio	266
WTAL	Toledo, Ohio	252
WTAM	Cleveland, Ohio	390
WTAN	Mattoon, Ill.	240
WTAS	Elgin, Ill.	275
WTAU	Tecumseh, Neb.	360
WTAW	College Station, Texas	254
WTG	Manhattan, Kan.	360
WVAC	Waco, Texas	360
WVAD	Philadelphia, Pa.	360
WVAX	Laredo, Texas	360
WVB	Canton, Ohio	268
WVI	Dearborn, Mich.	273
WWJ	Detroit, Mich.	517
WWL	New Orleans, La.	280
WYG	San Antonio, Texas	360
6KW	Tuinecuc, Cuba	315

Telmaco Radio Guide Book

Describes the Best in Radio

Our new 64-page Catalog No. TCR contains twenty of the most popular radio circuits printed in blue. These include the Hazeltine Neutrodyne, Grimes Inverted, Colpitts, Flewelling, Reinartz, Diode Electrad, Heterodyne, Super-Regenerative and many others. Each article used in circuit is attractively pictured instead of appearing in straight schematic form. Besides containing blue prints, the best in radio is also illustrated and described. Catalog sent postpaid for Ten Cents. Each circuit worth double. Send for your copy today.

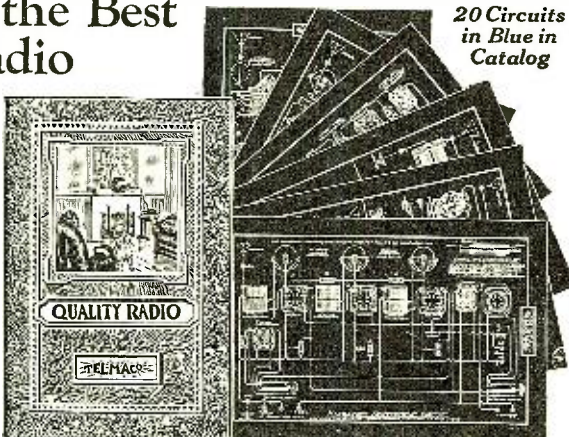

DEALERS! Our New Dealers' Catalog and Price List describes nearly all the better Standard Radio Lines. You should have it. Mailed FREE to all bonafide dealers making request on their business stationery.

Radio Division
TELEPHONE MAINTENANCE CO.
20 So. Wells St., Dept. B, Chicago, Ill.

Quality Radio Exclusively

The Pritchard Universometer

(Continued from page 719)

Here the phones are left connected to the regular receiving set, which is tuned to bring in a strong signal, of known wave-length for calibration, or of unknown wave-length if the meter has been calibrated and the length is desired. Strap 1 is removed, strap 2 is connected, and no other connections are made. The inductance of the Universometer is brought quite close to the secondary of the regular receiving set, and the condenser is turned slowly until a single click is heard in the phones. If two clicks are heard, move the meter slightly until only one click is heard. To do this without completely killing the received signal requires a little practice, but is repaid by securing very accurate readings.

A better source of known wave-lengths is provided for this purpose, at stated intervals, by the Government Bureau of Standards, Washington, D. C. These wave-lengths are absolutely accurate and the experimenter will thus secure reliable calibration.

When the Universometer is calibrated, its use as a wave filter is apparent. The set is connected with its antenna post (AN) to the aerial of the receiving station and its ground post (G) to the antenna of the receiving set. No straps are used, or other external connections and the inductance and variable condenser of the meter are in series. To place the condenser and induc-

RADIO

Complete Stock—Both Sets and Parts—
All Makes

ROSE RADIO SUPPLY

129 Camp Street New Orleans, La.
Send 10c for latest catalog

ENGRAVING MACHINES

For
RADIO PANELS
And Other Radio Engraving

ENGRAVERS & PRINTERS MACHINERY CO.

Sag Harbor, N. Y.



RADIO AT NEW YORK PRICES

Via Daily Parcel Post

The Prices Quoted Below Deliver Goods to Your Door

REFERENCES:
R. G. Duns, Bradstreet, Coal & Iron National Bank, Corn Exchange Bank, N. Y. City. No salvaged goods handled. Only standard brands in original packing, which bears ours and the manufacturers' guarantee. Due to our tremendous output we can undersell any of our competitors. Send your order in today and insure prompt delivery.

HOW TO ORDER—Write your order plainly; state number, description and price of items wanted. Send Post Office or Express Money Order, personal check or bank draft.



VACUUM TUBES

Standard brand Radio Corp. tubes. Guaranteed brand new.

J50 Detector, U.V. 200 ea.	\$4.25
J51 Amplifier, U.V. 201A ea.	5.75
J52 1 1/2 volt W.D. 11 ea.	5.75
J53 W.L. 12 ea.	5.75
J54 U.V. 199 ea.	5.75
J55 U.V. 199 Adapter for U.V. 199 tube fits any socket ea.	.50
J56 W.D. 11 Adapter fits W.D. 11 tube and any standard socket ea.	\$.50

AUDIO FREQUENCY TRANSFORMERS

The following transformers are guaranteed standard makes, and will produce very efficient results.

J63 Dietzen 2 to 1 Ratio	\$3.95
J64 Dietzen 3 to 1 Ratio	3.95
J65 Dietzen 10 to 1 Ratio	3.95
J66 Aeme Audio	4.25
J67 Amertran	5.95
J68 U.V. 712 R.C.A.	5.75
J69 U.V. 714 R.C.A.	5.75

LOOP AERIAL

J76 Can be assembled by anyone in five minutes. All wood parts, wire and binding posts included, complete.

J-176 . . . Our Price \$1.00

MOULDED BAKELITE VARIOMETER

J79 Ea. \$5.75. 1st. \$8.00

A high grade instrument. Takes in the wave lengths from 250 meters to 800 meters. Table or Panel Mounting.

FRESHMAN VARIABLE GRID LEAK AND GRID CONDENSER

Lowest filament current increases battery life; eliminates howling; zero to 5 meg-ohms.

J102 Freshman Variable Grid Leak a one. \$0.65

J103 Freshman Variable Grid Leak and Condenser combined. .85

FILAMENT CONTROLLED RHOESTATS

Highest grade of material used, tapered knob.

J104—6 ohm	\$.39
J105—30 ohm	.49
J106—200 ohm Patent-trometer	.79
J107—100 ohm Patent-trometer	.79

WAVE TRAP

Simplifies tuning. Eliminates interfering stations, thereby improving the selectivity of your set. Selects between conflicting stations. Special white quartz lasts.

J131 Each \$4.95

HONEYCOMB COIL MOUNTINGS

J140 2-coil mounting	\$2.85
J141 1-coil mounting	3.79
J142 Single coil mounting	.40
J143 Reciprocal for single coil mounting	.50

MISCELLANEOUS

J163 Spaghetti Tubing per yd.	\$0.09
J164 Synthetic Crystal	.30
J165 Ground Clamps	.17
J166 Black Rubber Binding Posts	.95
J167 Nickel Plated Binding Posts 2 for .05	
J168 No. 18 Amnuciated Wire half pound coil	.39
J169 6 ft. Phone Cord with tips	.79
J170 30 ft. Extension Cord with tips	1.95
J171 Wall Insulators, Porcelain	.05
J172 Porcelain Insulator in Insulators 1 in.	.10
J173 Reinartz Coil	1.45
J174 Cockaday Coil	2.45
J175 2 in. Dial and knob	.25
J176 3 in. Dial and knob	.35
J177 4 in. Dial and knob	.48

BUILD YOUR OWN SET

COCKADAY CIRCUIT COMPLETE

Consisting of

- 1 Cockaday coil and 7 pigtail connections
- 2 .0005 Variable Condensers
- 1 Socket
- 1 Panel 7x18
- 1 Dials, 3 in.
- 1 Grid Leak and Condenser
- 1 Rheostat
- 1 Switch Lever
- 1 Base Board
- 12 Pt. Bus Bar
- 7 Switch Points
- 7 Marked Binding Posts
- 1 Jack

Wiring Diagram and Instructions

J-178 . . . Our Price \$12.65

FLEWELLING CIRCUIT COMPLETE

Consisting of

- 1 .0005 Variable Condenser
- 3 .006 Mica Condensers
- 1 7x12 Panel
- 2 Coil Honeycomb Mount
- Variable Grid Leak and Condenser
- 1 30 turn Honeycomb Coil
- 1 75 turn Honeycomb Coil
- 2 Coil Mounts with straps
- 1 Dial, 3 in.
- 8 Marked Binding Posts
- 1 Baseboard
- 1 Jack

Wiring Diagram and Instructions

J-180 . . . Our Price \$12.45

HARD RUBBER PANELS

The highest grade panel on the market. Highly polished finish; cut in the following sizes:

188—7x10	\$0.95
J89—7x12	1.15
J90—7x11	1.25
J91—7x18	1.65
J92—7x21	1.95
J93—7x24	2.20

HIGH GRADE MOULDED VARIOMETERS

J97 Price \$2.65

A real high grade job at extremely low price. Takes in all wave lengths.

J98 Wooden Variometer same as above type \$2.65

IMPROVED OUTDOOR LIGHTNING ARRESTER

Passed by the Board of Fire Underwriters. Regularly sells for \$1.50.

J108 \$0.95

AMPLITONE LOUD SPEAKERS

This speaker will give efficient results when used with any pair of Head Phones; highly nickel plated; 18 inches high.

J117 \$3.95

STANDARD BRAND HEAD PHONES

J134 Brandes Superior	\$5.25
J135 Dietzen	6.75
J136 Baldwin Type "C"	Double . . . 9.85
J137 Baldwin Type "C"	Single . . . 4.95
J138 Western Electric	10.50
J139 Dietzen 3000 ohms extra special	3.95

Modell's

71 Cortlandt St. New York, N. Y.

America's Greatest Radio Mail Order House

ELEVEN NEW YORK STORES

BUILD YOUR OWN SET

REINARTZ CIRCUIT COMPLETE

Consisting of

- 1 Reinartz Coil and 16 pigtail connections
- 1 11-Plate Condenser
- 1 Socket
- 1 Vernier Rheostat
- 3 Switch Levers
- 1 7x11 Panel
- 1 Base Board
- 8 Marked Binding Posts
- 12 Pt. Bus Bar
- 1 Grid Condenser
- 2 doz. Switch Points and stops

Wiring Diagram and Instructions

J-179 . . . Our Price \$10.85

ULTRA AUDION CIRCUIT COMPLETE

Consisting of

- 1 7x12 Panel
- 1 Variable Condenser .0005
- 1 Socket
- 1 Variometer
- 1 Vernier Rheostat
- 1 Grid Leak
- 1 .0002 Mica Condenser
- 7 Marked Binding Posts
- 1 Base Board
- 15 Pt. Bus Wire

Diagrams and Instructions

J-181 . . . Our Price \$9.65

1 1/2 VOLT DIETZEN TUBE

Two-element Fleming valve effect; operates on one dry cell with or without "B" Battery; wiring diagram free with each tube.

J95 Dietzen Tube \$1.00

J96 Socket for Dietzen Tube .40

BAKELITE TUBE SOCKETS

Moulded of brown bakelite; Binding Post Connections.

J99 Standard Type for 201A 301A, W.D. 12 . . . 39c

J100 For U.V. 199, U.V. 209 Socket . . . 39c

J101 For W.D. 11, C11 39c

RADIO SOLDERING IRON

Indispensable for the man who builds his own sets.

J109 \$2.50

J133 Soldering Paste Tube. .25

VARIABLE AIR CONDENSERS

These condensers are made of heavy aluminum plates, high grade bakelite ends.

J110—21 Plate .0005 Mfd.	\$1.75
J111—11 Plate .00025 Mfd.	L.25
J112—3 Plate .00005 Mfd.	\$0.95
J113—43 Plate .001 Mfd.	2.25

VERNIER VARIABLE CONDENSERS

Specifications the same as above.

J114—14 Plate Vernier with knob and dial	\$2.95
J115—26 Plate Vernier with knob and dial	3.45
J116—43 Plate Vernier with knob and dial	3.95

MAGNET WIRE (8 oz.)

Double Cotton Covered	Price	Green Silk	Price
J144 18	\$0.43	J145 18	\$0.73
J146 2053	J147 2065
J148 2268	J149 22	1.00
J150 2478	J151 24	1.13
J152 2688	J153 26	1.65
J154 28	1.07	J155 28	1.95
J156 30	1.58	J157 30	2.65

WOOD CABINETS

Highest grade Mahogany finish Cabinets Hinged top. These cabinets are being sold at less than one-half regular value.

J57 Wood Cabinet; panel size 7"x10"	\$2.50	
J58 Wood Cabinet; panel size 7"x12"	2.75	
J59 Wood Cabinet; panel size 7"x14"	3.00	
J60 Wood Cabinet; panel size 7"x18"	3.50	
J61 Wood Cabinet; panel size 7"x21"	Each	3.75
J62 Wood Cabinet; panel size 7"x24"	Each	4.00

RADIO FREQUENCY TRANSFORMERS

J70 Tri-coil for 201A or 301A tubes	\$1.95
J71 For 199, 299 or W.D. 11 and 12 tubes	1.95
J72 Erla AB1	3.75
J73 Erla AB2	3.75
J74 Erla AB3	3.75
J75 Erla Reflex	4.65

VARIOCOUPLER

J77 High Grade 180 Degree Coupler made of Bakelite tubing wound with green silk wire. Special . . . \$2.65

J78 Variometer same specifications . . . \$2.65

PLATE CIRCUIT "B" BATTERIES

The highest grade of battery made at prices lower than they ever were sold before.

J80—2 1/2 Volt	\$1.15
J81—2 1/2 Volt Small	1.45
J82—2 1/2 Volt Medium	1.95
J83—15 Volt Medium	1.95
J84—15 Volt Large	2.50
J85—15 Volt Extra Large	3.50
J86—300 hr. 1 1/2 Volt twin double duty "A" Battery	.75

RUSONITE

CRYSTAL MULTIPoint RECTIFIER

J159 The perfect synthetic crystal detector sensitive over entire surface. Loud and clear. Price, mounted . . . 50c

J160 14 K. Gold Super-sensitive Rusonite Catwhisker. Permanent. Will not oxidize. Price . . . 25c

J161 Rusonite Reflex Crystal. Manufactured expressly for Reflex Circuits. Guaranteed. Price, mounted . . . \$1.00

JACKS AND PLUGS

Jacks are polished nickel constructed with pure silver contacts.

J118 One Spring open circuit	\$0.39
J119 Two spring closed circuit	.49
J120 Round plug as illustrated	.49

AERIAL WIRE

J121 100 ft. solid copperweld wire coil	\$4.99
J122 7 strand 100 ft.	.69
Ground Wire Rubber Covered No. 14	
J123 25 ft. coil	\$4.49
J124 50 ft. coil	.85

INSULATORS

These are very strong strain type insulators.

J158 Moulded insulator shown Ea. Doz. above \$0.10 \$1.10

LOUD SPEAKERS

J125 Herald Loud Speaker; no extra battery required. The ideal instrument for the home, school or church. New \$30.00

J126 Magnavox new type \$29.95

J127 Musi-Master 28.50

J128 Atlas Speaker 22.50

J129 Pathe Speaker 21.95

J130 Dietzen Speaker 18.95

The above prices delivered to your door.

LEARN NEWS- PAPER WORK

Experienced Editor Will Teach You
How to Become a
Reporter.

FASCINATING WORK--GOOD PAY

Only a Few Months' Work Required
To Qualify You for a
Better Position.

Regular reporters earn from \$40 to \$125 a week. Good deskmen on a daily paper are paid from \$60 to \$100 a week. A "Star" Reporter can command his own salary. Hundreds of ambitious men and women enhance their income materially by corresponding for newspapers or writing for magazines in their spare time.

We Will Teach You at Home

We can develop your talent for writing and lead you into this well paying profession. Our Practical Course in Journalism was personally prepared by Henry J. Brockmeyer, Assistant City Editor of the New York Evening Post. Mr. Brockmeyer has trained hundreds of men and women, many of whom have, under his guidance, developed into front rank reporters or feature writers.

Mr. Brockmeyer's course will teach you what it would take years of actual newspaper work to learn. It consists of six comprehensive lessons just brimful of everything a reporter must learn. The following are only a few of the innumerable subjects covered.

Starting in Journalism. What is a Newspaper? What is News? Start and Finish of a News Story. Technical Terms. The Type Point System. Styles of Type. Proof Reading. Capitalization and Punctuation. A Late Fire Bulletin. Court Stories. Libel Laws, Copyright. Hints to Reporters. Personal Conduct. Re-Writing and Condensing Stories. Paragraphs and Short Items. Good and Bad Styles. Broadening the Vocabulary. Aids to Good Style. Special Stories. Suggestions for Stories. Rhetoric. Preparing Your Story. Don'ts for Writers. Office Organization. Syndicated Matter. Business Office. Mechanical Department. Hints for Headline Writers. The Make-Up. The Country Correspondent, etc., etc.

This Complete Course For \$10

The price for the entire course is only \$10, and entitles the student to full consulting services which are directed by Mr. Brockmeyer personally, including any questions in connection with journalistic work.

Five Days' Trial

Just pin a check, money order or ten dollar bill to the coupon below and mail. Then take five days after the course arrives to decide whether you want to keep it. If not, return it at our expense and your money will be immediately refunded and no questions asked.

Or Write For Free Circular "R"

THE PRESS GUILD, Inc., 66-R-W. B'way, N. Y.

THE PRESS GUILD, Inc.,
66-R—West Broadway, New York City

Enclosed find \$10 for which you are to ship me at once, prepaid, Henry J. Brockmeyer's complete course in Practical Journalism with the distinct understanding that if I return the course in five days my full \$10 will be refunded and no questions asked.

(Name)

(Address)

(City) (State)

tance in parallel, see that the cat whisker is off the crystal; connect strap 2 as shown in Fig. 2; leave the flash light lamp in its socket and the antenna connected at (AN); place a shorted plug in the receiver jack (RJ) and connect the antenna post of the regular receiving set to the binding post B. By these arrangements, the condenser may be set to isolate a desired wave-length or block out one that is undesirable.*

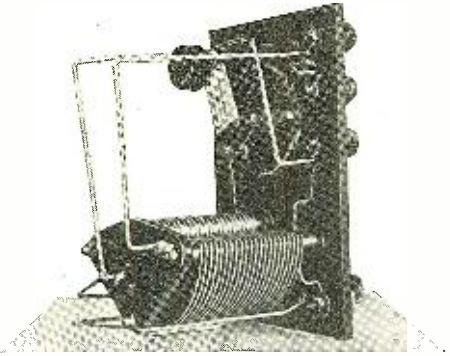

Another View of the Universometer Showing the Variable Condenser Rheostat, Grid Condenser and Grid Leak.

The operation of the Universometer as a crystal receiving set is identical with its use as a wave meter on incoming signals, with addition of connection to the aerial on the antenna binding post (AN) and ground at G. Strap 2 is, of course, left in place.

As a tube receiver, the circuit is arranged to give regeneration, simplicity, and wide condenser range. The aerial is connected to the antenna post (AN) and ground to G. Strap 1 is connected and strap 2 removed, the cat whisker is lifted and "A" and "B" batteries are connected as shown by the dotted lines. So connected, and with the proper inductance coil in place, the set is ready for use as a substitute for the experimenter's regular receiving set, or wherever a small, portable set may be used to advantage.

Other uses, such as a tuner in connection with a loop, will occur to the builder of one of these sets.

*RADIO NEWS for August, 1923, page 145.

4QS

The call 4QS has been assigned to W. H. Knowles, Jr., Pensacola, Fla. Any report on the I. C. W. signals of this station will be appreciated.

8CDC

QRA, 8CDC, John Taylor Galey, 363 Third Street, Beaver, Pa.

NOTICE

Walter Hemrich of 7SC, Aberdeen, Wash., is operating AEB at Kukak Bay, Alaska. This is on the mainland from Kodiak Island and is bordering Shelikof Straits. A transmitter now in operation consisting of two 5-watt tubes or one 50-watt tube is used. Since July 2nd amateurs of the 5th, 6th, 7th, 8th and 9th districts have been logged. An attempt will be made to establish communication with the States. The set may be distinguished by its 500-cycle note.

8CQN

The call letters 8CQN have been issued to Ralph Powers, 5138 Gratiot Avenue, Port Huron, Mich. Would appreciate word from persons logging me. All cards ans.

2AOT

2AOT has been reassigned to Clarence Roebeling, 2748 Fulton Street, Brooklyn, N. Y. Would appreciate word from persons logging me.

Guaranteed Radio Outfit at Wholesale Price

The Greatest Radio Value of the Year

A complete outfit fully guaranteed to receive from all Broadcasting Stations upward of 2000 miles distance. Everything you need is included in the set.

Standard single tube long distance receiving set in fine cabinet equipped with Bradley Rheostat—WD-12 tube—One set of head phones—"B" Battery—WORLD Storage Battery guaranteed to run 200 hours, rechargeable. And all other necessary equipment, aerial wire and insulators. You can install this outfit in less than thirty minutes, ready to receive from all Broadcasting Stations.

Regular Retail Value
of this Outfit \$62.50

Our
Special Price **\$29⁵⁰**

This is your greatest opportunity of the Radio Season to get all the equipment needed for less than the retail price of the receiving cabinet alone. All parts carry our full guarantee.

SEND NO MONEY. We ship C. O. D. subject to inspection or will allow 5% for cash with order.

Complete stock of Radio equipment and parts at wholesale prices. Write for quotations.

World Battery Company

Radio Dept. Desk 12

60 E. Roosevelt Road Chicago, Ill.

You Know These HEADBANDS

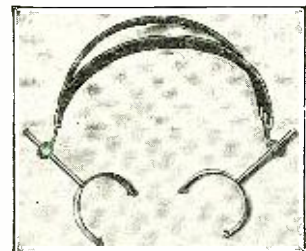

Simple friction slide adjustment.
Most satisfactory on the market.
No thumb screws to bother with
or to catch in the hair.
Two yoke sizes fit any 'phones.
Bands covered in Black or Khaki
webbing.

Prompt deliveries on any quantity.

\$500,000.00 worth of special and automatic machinery assures quantity output and guaranteed delivery for manufacturers and dealers on any radio equipment.

Submit sample of product. Write for prices.

THE AUTOYRE CO.
OAKVILLE, CONN.

WORKING KNOWLEDGE Of Radio Code and License

One Week. Top records our students: Code 15 Min. Ten word Speed 3 hours. Best 40 records free or DIME prints 100 made by Beginners now Licensed. Simple Instructions that do instruct only \$2.00. Dodge Radio Shortkut, Dept. N, Mamaroneck, N. Y.

Build your own Sets!

REINARTZ CIRCUIT

Reg. Price	Consisting of	Our Price
\$1.89	7x18 Formica Panel	\$1.70
1.00	John Firth Socket	.45
1.50	Howard Vernier Rheostat	1.35
3.30	23 Plate Variable Condenser	1.45
3.10	11 Plate Variable Condenser	1.35
1.00	2 Bakelite dials ea.	.25
1.50	3 Switch Levers	.75
.80	2 dozen switch points	.40
2.50	1 Schoonhoven Reinartz Coil	1.95
1.00	Freshmat. Variable Grid	.65
.80	Binding Posts	.40
.30	25 feet Tinned Wire	
.50	Baseboard	.25
\$21.19	Our Value	\$11.45

7 famous circuits for you to choose from. Build these sets NOW!

Panels Drilled for each outfit at no additional charge. Everything's ready—just to be put together!

Complete Instructions for wiring and assembling are included with every outfit. No special skill or technical knowledge required—a few hours and you're ready to tune-in New York, Los Angeles—any of 'em.

HAZELTINE NEUTRODYNE

ALL PARTS LICENSED UNDER HAZELTINE PATENTS

- 1 7x21x3-16 drilled formica panel
- 1 Howard rheostat
- 3 4" Radion Dials
- 3 John Firth bakelite sockets
- 8 Binding posts
- 3 23 plate variable condensers
- 1 Wave control neutroformer
- 2 Radio frequency amplifying neutroformers

- 2 Grid neutralizing condensers
- 1 .00025 micon grid condenser
- 1 Marco variable grid leak
- 1 Base board for mounting
- 25 feet tinned copper bus bar wire and complete instructions for assembling and wiring.

\$28⁶⁰

COCKADAY CIRCUIT

Reg. Price	Consisting of	Our Price
\$3.00	1 Cockaday Coil	\$1.95
1.00	2 Bakelite Dials	.25
1.00	1 John Firth Socket	.45
1.00	Freshman Grid Leak and Condenser	.65
1.50	1 Howard Vernier Rheostat	1.35
1.00	1 Pacent Double Circuit Jack	.50
.80	8 Binding Posts	.05
.02	7 Switch Points	.01
.10	1 Switch Lever	.25
.50	1 Switch Lever	.25
	1 7x14x ¹ / ₂ Formica Panel	1.44
	Blue Print and Wire	1.03
	1 Baseboard	.25
3.30	2 23 Plate Condensers	1.45
\$11.95	Our Price	

ERLA SINGLE TUBE REFLEX CIRCUIT

Consisting of	Our Price
1 Variocoupler	\$3.45
23-Plate Variable Condenser	1.45
2 Erla Sockets	1.30
1 Erla Reflex No. 1 Transformer	3.95
1 Erla A. F. Transformer	4.85
1 Erla .002 Mica Condenser	.30
1 Erla .001 Mica Condenser	.30
1 Erla .00025 Mica Condenser	.25
1 Erla Fixed Crystal Detector	1.00
1 Howard Rheostat	1.00
2 Bakelite Dials	.50
8 Binding Posts	.40
1 dozen Switch Points and 4 Stops	.30
2 Switch Levers	.50
1 6 ¹ / ₂ x14x ¹ / ₂ Formica Panel	1.37
\$20.90	Our Price

Important! Any part listed in these 7 circuits may be purchased separately at our CUT PRICES

Here's big news VT-2 for you in TUBES

We just bought 10,000 WESTERN ELECTRIC 5-Watt "E" Tubes Type CW-931 or VT-2 Tubes!



\$745

Just bought 10,000 brand new Genuine Western Electric VT-2 Tubes from the U. S. Signal Corps. They were built specially for the Signal Corps. Our purchase makes it possible for you to get a genuine VT-2 Tube for \$7.45. Don't wait! Write for your tubes today—even though there's 10,000 of 'em they won't last long at that price.

These Genuine Western Electric 5-Watt "E" Tubes, Type CW-931 or commonly known as VT-2 Tubes were designed and built specially to conform to the specifications of the U. S. Signal Corps. They are built to be used both for Radio and Audio Frequency Amplification and for CW and Phone Transmitting.

One of the outstanding features of these tubes is the fact that they have a higher amplifying factor than any other tube made.

KNOCKED-DOWN SHORT WAVE RECEIVER

Reg. Price	Consisting of	Our Price
\$10.00	2 Variometers	\$3.90
5.00	1 Variocoupler	1.75
3.00	3 Bakelite Dials	.75
1.00	John Firth Socket	.45
1.10	Howard Rheostat	1.00
4.50	Mahogany Cabinet	2.95
2.25	Genuine Formica Panel	1.75
.80	8 Binding Posts	.40
.50	Switch Lever	.25
.40	12 Switch Points	.20
1.00	Freshman Grid Leak and Condenser Combined	.65
1.00	Complete Drawing for Assembly and Wiring	.50
\$25.85	Our Value	\$13.45

FLEWELLING CIRCUIT

Reg. Price	Consisting of	Our Price
\$1.26	6x14 Formica Panel	\$1.10
3.30	23 Plate Variable Condenser	1.45
3.00	Three .006 Micon Condenser	2.25
1.85	CRL Variable Grid	1.35
.40	Remier Grid Leak	.25
4.00	2 Coil Adjustable Honeycomb Coil	2.65
.75	50 Turn Honeycomb Coil	.40
.80	75 Turn Honeycomb Coil	.40
1.20	2 Remier Coil Mounts with straps	.80
1.00	1 Socket	.45
1.50	Howard Vernier Rheostat	1.35
1.00	1 Bakelite 3" Dial	.25
.80	8 Binding Posts	.40
.30	1 Baseboard	.20
1.00	1 Blueprint with Complete Instructions for Assembly and Wiring	.50
\$22.16	Our Value	\$12.45

AUTOMATIC ELECTRIC PHONES



New 48 Page Catalog Now Ready! Lists and describes hundreds of unusual radio bargains. Send 10c (to cover mailing charges) for your copy.

We Guarantee all our merchandise to be of the BEST QUALITY

40,000 head sets—the entire stock of the Automatic Electric Co., of Chicago—for us a single purchase. Here is but one of the many opportunities our enormous buying power offers you—in this special case, a splendid, Automatic Electric \$10 head set for only \$3.65.

The Automatic Electric Head set embodies a style and design proved by use and experiment to be the best. Coil wound with about 6500 turns of No. 40 enamel coated copper wire. Direct current resistance approximately 1600 ohms. Impedance at average music and voice frequency (800 cycles) is 21,000 ohms.

\$3.65



Mail Orders Given Immediate Attention

2 STAGE AMPLIFIER

Can be used to amplify Ultra-Audion Reinartz, Flewelling, knocked down short wave receiver, crystal or any receiving set so that loud speaker or phonograph can be used in place of headset. Consisting of:

Reg. Price	Consisting of	Our Price
\$1.05	7x9 Formica Panel (Other suitable size)	.95
4.75	High Ratio All-American or Thordarson Transformer	3.95
4.50	Low Ratio All-American or Thordarson	3.95
2.20	2 Howard Rheostats	2.00
2.00	2 Remier Bakelite Sockets	.90
3.00	3 Double Pacent Jacks	1.50
1.30	13 Binding Posts	.65
.30	Baseboard for Mounting	.15
\$21.00	Our Value	\$12.95

TRADE "ESCO" MARK

The things that have endured for ages were made of quality—the cheap things have passed on—and are forgotten

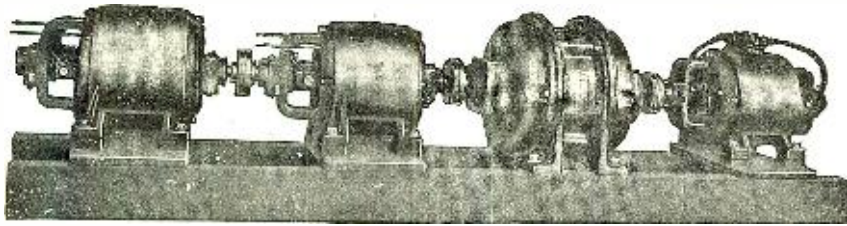

"ESCO"

HIGH VOLTAGE MOTOR-GENERATORS STAND PRE-EMINENT. Used by leading EDUCATIONAL INSTITUTIONS Everywhere. Also many GOVERNMENT DEPARTMENTS—RESEARCH LABS., NEWSPAPERS, DEPARTMENT STORES AND COMMERCIAL BROADCASTING STATIONS.

Bulletin 237A lists over 200 Combinations

This is our new BATTERY CHARGER, made in many sizes—with or without panel board MOTORS, DYNAMOTORS, GENERATORS, MOTOR GENERATORS DEVELOPED FOR SPECIAL REQUIREMENTS.

Send us your problems—we'll solve them

ELECTRIC SPECIALTY CO.

211 South St., Stamford, Conn., U. S. A.

Pioneers in developing High Voltage Apparatus

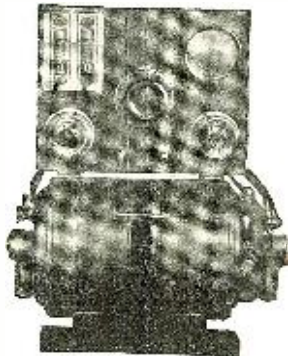

Radio Trade News

(Continued from page 723)

Looking back over 1922 it is interesting to note that the revival of buying from jobbers and manufacturers started about the 20th of November. If any increase in buying is expected for this time in 1923, it will be only an increase in orders, as few, if any, factories will be able to handle the production to supply the orders. Central Western manufacturers report heavy bookings of orders for deliveries late in November, while Eastern firms say the trade is ordering for deliveries early in November.

Until 1923 a drop in radio sales was always experienced in February and March. This past season gave the lie to the history of radio merchandising, and it is felt that the summer slump of 1924 will be even less noticeable than the fall off last summer, which by the way, did not come until the summer months were here, instead of beginning in the early spring.

Radio shows throughout the country serve to bring new converts, and with their past experiences promoters of shows are producing more creditable exhibitions than in previous years. This can do nothing but aid business.

The improvement in the quality of radio advertising is looked upon by the trade as one of the most healthy indications. One national firm carries a series of page advertisements in color in a national medium—advertising receiving sets and loud speakers while the advertiser makes only accessories. Other good-will advertising is appearing from time to time, and it is felt that the radio industry stands on the threshold of a new variation in the advertising appeal.

A large part of the change in the advertising appeal is the effect caused by the feeling that the complete set business can be developed to greater proportions, and an appeal designed for the home person who cannot—or will not—build a set, must be different from that aimed at the technically inclined individual.

While the trade at large reports an increase in the sale of complete sets, it is interesting to note that a check up on a number of retailers where parts and sets are sold, shows that the sale of parts has not decreased in the least.

The answer to this is that by the pushing of the sale of complete sets, the sale of parts for sets is held up automatically, while the sale of sets grows. It is certain that the "tinker" instinct so strong in the American public will never be killed in radio, certainly not until some method can be devised whereby sets can be sold for less than the parts would cost at retail.

Experiments in wired wireless broadcasting, following the lines of power companies are attracting considerable interest in the trade, but at this writing the experiments have not progressed far enough to justify a decision as to whether or not these plans will be practical or will remain permanent. Only time can show this phase of radio broadcasting and operation. A number of plans for handling this broadcasting have been suggested and several of them are being tried out by electric light companies and others who are likely to be most effected by this development.

At a general meeting of the Association held at Hot Springs recently, the following recommendations were presented by the radio committee and unanimously adopted by the Association:

THE TRINITY LOUD SPEAKER



TYPE "A1"
21" FIBER
HORN
\$25.00

TYPE "B"
(For Phonographs)
\$12.50

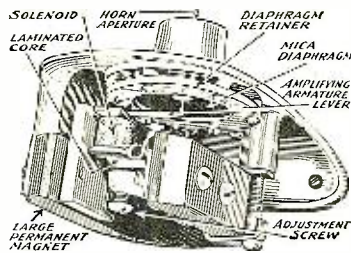

An ear phone is an ear phone no matter how fancy the horn that covers it may be, and, due to the delicate construction of an ear phone it is utterly incapable of giving true tone reproduction, especially, when relatively large currents are passed thru its coils, such as the output of a two-stage or power amplifier.

The Trinity Loud Speaker element embodies the well-proven and tested principles of the phonograph reproducer with the soundest principles of electromagnetic design best adapted for loud speaker operation. It is not an ear phone when placed on a head band and a loud speaker when covered with a horn. It is a sturdy loud-speaking element ALWAYS.

Send for Literature.

TRINITY RADIO CORPORATION

466 TREMONT STREET, BOSTON, MASS.

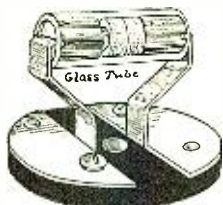

Star Detector

Combination Crystal Set by turn of tube. Volume and Distance.

List Price, 50c.

STAR MFG. CO.,
868 Bergen St., Newark, N. J.

BECOME A PROFESSIONAL PHOTOGRAPHER

EARNING \$35 TO \$125 A WEEK

Three to six months' course. Motion Picture, Commercial, Portraiture. Practical instruction. Modern equipment. Ask for Catalog No. 56.



N. Y. INSTITUTE OF PHOTOGRAPHY
NEW YORK CHICAGO BROOKLYN
141 W. 36th St. 630 S. Wabash Ave. 505 State St.

A Chemistry Laboratory for \$7.00

Think of it, fellows! Here is a *real* chemistry outfit with regular chemical apparatus that performs those fascinating, actual chemical experiments. This outfit is not a toy, put up merely to amuse, but a practical laboratory set, with all the chemicals, apparatus and reagents necessary to perform real work and to teach the beginner all the secrets of inorganic chemistry.

DESCRIPTION OF THE OUTFIT

The outfit consists of 44 Chemicals and Reagents all C. P. put up in appropriate wooden boxes, glass bottles, and hermetically closed jars. The acids are put up in glass bottles, with ground-in glass stoppers, and there is a sufficient quantity of chemicals supplied (mostly one to two ounces) to make dozens of experiments with each.

The apparatus furnished are all of the best obtainable make and of standard laboratory size and shape.

The Instruction Book is a real Chemistry Course for the Beginner. Some of the Contents are: Division of Matter; This is a Treatise on Elementary Chemistry and deals with the theory of the Elements, Molecules and Atoms, etc. Chemical Nomenclature: This explains in simple language the derivation of the chemical names of the elements and their compounds. There is a chapter on Laboratory Operations; Glass Working; First Aid; Fire Extinguishers; Experimenters' Aphorisms, etc.

A good part of the book is devoted to Weights and Measures. The Metric System, The English System and the U. S. System are fully explained.

The following tables are furnished: Symbols and Atomic weights of the Elements; Measures of Weights, Volume, Capacity and Length; per cent solutions; Conversion of Measure expressed in parts; poisons and their antidotes; technical and common name of chemical substances; formulas for cleaning various substances, etc., etc.

Among the 100 Experiments are:

How to make chemical tricks; How to make invisible and magic inks; How to test flour; How to test soil; How to make chlorine gas and smoke (German War Gas); How to bleach cloth and flowers. How to produce Oxygen and Hydrogen; How to make chemical colors; How to test Acids and Alkalies and hundreds of interesting hints and formulas.

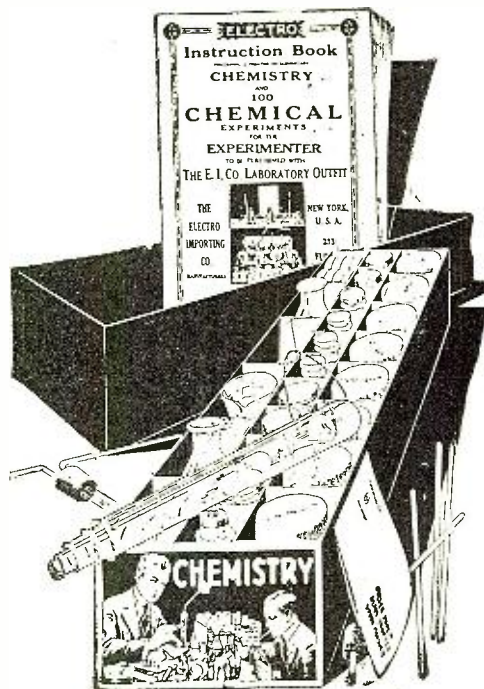

Complete, \$7.00 Sh. Wght, 10 lbs. (Shipped by Express only)

(We guarantee shipment within 24 hours after your order is received.)

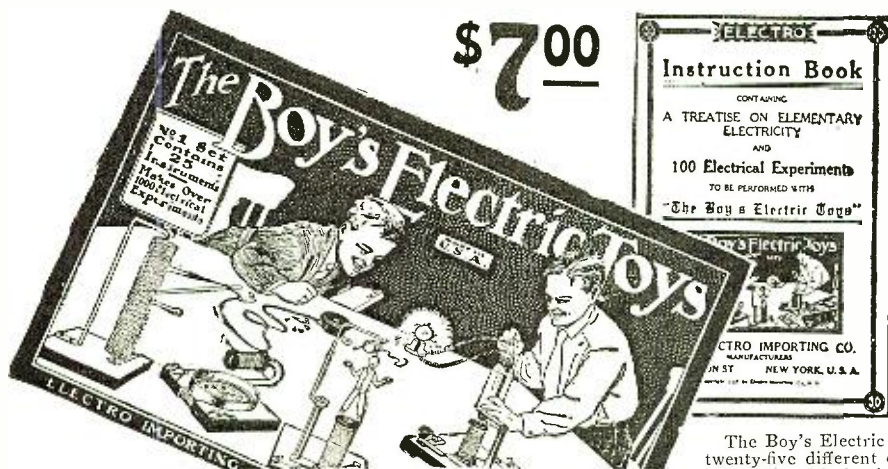

Every Fellow Wants the BOY'S ELECTRIC TOYS

The Boy's Electric Toy contains: Enough material to make and complete over twenty-five different electrical apparatus without any other tools except a screw-driver furnished with the outfit. Student's chromic plunge battery, compass-galvanometer, solenoid, telephone receiver, electric lamp, etc. Enough various parts, wire, etc., are furnished to make the following apparatus:

Electromagnet, electric cannon, magnetic pictures, dancing spiral, electric hammer, galvanometer, voltmeter, hook for telephone receiver, condenser, sensitive microphone, short distance wireless telephone, test storage battery, shocking coil, complete telegraph set, electric riveting machine, electric buzzer, dancing fishes, singing telephones, mysterious dancing man, electric jumping jack, magnetic geometric figures, rheostat, erratic pendulum, electric-butterfly, thermo-electric motor, visual telegraph, etc., etc.

With the instruction book we furnish one hundred experiments that can be made with this outfit, nearly all of these being illustrated with superb illustrations. No other materials, goods or supplies are necessary.

The outfit contains 114 separate pieces of material and 24 pieces of finished articles ready to use at once.

The size over all of the outfit is 14 x 9 x 2 3/4. Shipping weight, 8 pounds.

"The Boy's Electric Toys" outfit as described, \$7.00
Immediate shipment.

SEND NO MONEY

We have so much confidence in these sets that we desire to ship either one to you by express C.O.D. with the privilege of inspection. In other words, we ship on approval. It does not cost you one cent to take a good look at whichever outfit you want, and see if it comes up to your expectations. If it does, pay the express man \$7.00, plus express charges. If not, you need not accept it, and we will pay the return charges as well.

ELECTRO IMPORTING CO., 233 Fulton Street, New York City

ELECTRO IMPORTING CO.,
233 Fulton St., New York
Please send me by express THE CHEMICAL LABORATORY. If I don't like it I need not accept it. If I want it I only pay \$7.00 plus the few cents express charge.

ELECTRO IMPORTING CO.,
233 Fulton St., New York
Please send me by express THE BOY'S ELECTRIC TOYS. If I don't like it I need not accept it. If I want it I only pay \$7.00 plus the few cents express charge.

A "B" BATTERY Built for Radio

By Radio Experts

The Improved Re-chargeable "B" Battery
Insures Noiseless Radio Circuits

With the SIDBENEL Re-chargeable "B" Battery you can count on four or six months' service on one charge alone. Recharging costs you only a few cents and with ordinary care the battery will last 5 YEARS in normal service. That is one of the many reasons why

Sidbenel Storage "B" Batteries

are universally recognized as "Perfect for Radio Work."

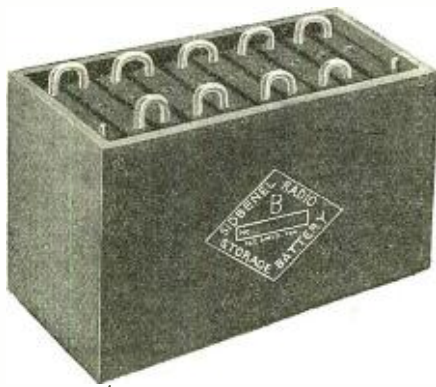

Its many SPECIAL NEW FEATURES include:

Hard Rubber Container
Separate sealed cover for each cell

Extra large plates
Brings signals in very loud.

SPECIAL PATENTED PLATES ARE USED

They will give an immediate discharge of FIFTEEN AMPERES and a voltage of twenty-two and one-half variable from two volts up. Should it become partly discharged at any time, just connect it to your charger, lamp-socket or lighting generator, and within a few hours your SIDBENEL STORAGE "B" BATTERY will be recharged to its full capacity, costing you less than one-half a cent, and saving you the price of a new battery. Each time the battery becomes discharged you simply recharge it.

Variable Type	201D Assembled	Knocked Down
1 unit	22½ volts.....	\$ 5.00
2 units	45 volts.....	9.80
4 units	90 volts.....	18.00
5 units	115 volts.....	22.50
A. C. Rectifier.....		1.50

Complete illustrated directions for charging from your lamp socket or from your generator and how to assemble come with each battery.

Send for complete catalog of parts

Trade in your old Sidbenel with \$2.00 for new type.

A Two-Year Guarantee with Every Battery

RADIO EQUIPMENT MANUFACTURING COMPANY
25 Mt. EDEN AVE., NEW YORK CITY



That manufacturers of radio materials supply their distributors with standard size 8½" by 10" price and data sheets.

That defective tubes and radio materials returned to manufacturers, where such returns are permitted, be credited rather than replaced in the interest of economy by the elimination of handling small shipments as in most cases the distributor has already made replacement or adjustment with the dealer.

That all portions of inside of instruments depending on the strength of the panel for support be reinforced by extra individual support of such unit so mounted to prevent breakage by rough handling.

That manufacturers pack and ship receiving sets in individual cartons or crates of sufficient strength to permit reshipment in original package.

That all manufacturers of receiving sets of a value of \$25 or over supply these sets with a serial number to facilitate the tracing of lost or stolen sets, and that the serial number and catalog number appear on the outside of the container where it will appear to the best advantage in stocking on distributors' and dealers' shelves and further recommends that manufacturer, distributor and dealer use serial numbers on their invoices.

That the present practice of allotting radio materials on which the demand exceeds the supply be changed to conform to the practice of manufacturers of other lines handled by distributors, thereby rewarding the distributor who creates business and placing supplies where the demand is most urgent.

Fixin' Up the Shack

(Continued from page 704)

burner or coal stove. Bet it's rusty and full of last year's cold ashes right now! Rub it down with a bit of steel wool and finish it off with the conventional stove polish—now you've got a heater—not a rusty iron object!

Got any pictures in your shack? Put up just a few plain prints of famous radio stations or noteworthy figures in the industry. Don't neglect to hang your license, neatly framed, above the operating desk. By the way, the United States regulations require that the license be FRAMED AND POSTED IN THE STATION! Otherwise, you are guilty of a violation. Take down the mess of DX cards that you've papered your walls with. They look untidy and no one takes time to read 'em all. Display tastefully the main one from each district with an additional one from each foreign country. This gives you 10 or a dozen, which are plenty. File your others.

Now the set. If it's a spark, probably your oscillation transformer secondary is supported at a convenient distance from the primary by a piece of twine tied to a convenient nail or a hook under one corner. Doubtless, should you accidentally push your ash tray or pipe off the table, it would land squarely in the condenser tank! Your rotary probably makes enough vibration noise to almost drown the crash of the spark. The individual remedies are obvious. Make a substantial, permanent job of your installation. Bucher, in "The Wireless Experimenters Manual," shows a number of practical layouts, if you have no individual ideas. If at all possible, make your set up in the convenient panel form, but lay it out symmetrically and make the rear of the panel board look just as good as the face. Bring the necessary controls conveniently to the front of the board.

With a C.W. set, the same applies in general. A panel arrangement is by far preferable from the standpoint of appearance, convenience and efficiency.

The MU-RAD AUDIPHONE

WITH one daring stroke of genius, the MU-RAD AUDIPHONE transcends all previous conceptions of radio sound amplification. Modelled upon the principles of the human vocal organ. The super-sensitive mica diaphragm is actuated by an armature which expands and contracts just like the larynx in the throat. Hence, the MU-RAD AUDIPHONE responds in perfect harmony to all voice and music vibration ranges. Extremely fine, easily operated, exterior adjustment of diaphragm eliminates distortion.

No Extra Battery Connections—PRICE **\$25**

WRITE FOR BOOKLET AND NAME OF THE NEAREST MU-RAD DEALER!

MU-RAD LABORATORIES, INC.
801 FIFTH AVE ASBURY PARK, NEW JERSEY

RADIO SCHOOL

All our graduates are placed.
Shortage still exists. Wages going up.

Send for Catalog

MASSACHUSETTS RADIO & TELEGRAPH SCHOOL, Inc.
18 Boylston St. Boston, Mass.
G. R. ENTWISTLE, Radio Director

THE PROTECTOTUBE

No more burnt-out tubes. It is absolutely impossible to burn out any of the present vacuum tubes when you use the PROTECTOTUBE in your radio set. Can be inserted and forgotten. Will not change the volume or quality of radio reception in any way. If you accidentally put your "B" Battery voltage into the filament of the tube no harm will be done. THE PROTECTOTUBE is always good no matter how many times it saves your tube. Sent postpaid on receipt of \$1.00 or C.O.D. with full directions. Dealers and jobbers write for discounts.

J. E. McLAUGHLIN, Mfr.
7068 No. Ashland Blvd. Chicago, Ill.

The receiving set is generally of a good, reliable make, but don't just throw it on the table and hang loose wires on it and call it good. Secure it firmly in place and run neat leads through small holes direct to the binding posts. All of your wiring should be done in the same way.

Your power wiring must be correctly installed in an approved fashion. The National Board of Fire Underwriters has laid down certain definite rules for such wiring and the requirements can be had by writing them at 109 Leonard Street, New York City, and requesting their pamphlet, "Tentative Regulations of the National Board of Fire Underwriters for Radio Signaling Apparatus." I'll wager that if a few more parents knew that if, in the event of fire, defective wiring was proven against the radio equipment, no insurance would be allowed, there would be less haphazard methods in carrying power to the radio set.

Summing up, the idea is to make your station a model piece of work—not a junk shop. The broadcast listeners and others interested are not favorably impressed with your layout after they've seen some of the better broadcasting stations. Show 'em something attractive, and help your own game along. The writer has seen hundreds of amateur stations and has yet to find one that is really a model of excellence in every respect. Perhaps this is expecting too much; but at least make an effort to make even one improvement. You'll not regret it.

Duplex Reception

(Continued from page 708)

near the same wave-length as possible the removal of the hand from the neighborhood of either one of the sets would cause the reception to shift from one to the other, in fact there would be a sort of fluttering effect as one or the other brought in the signals.

When the aerial lead-in was divided between the two sets and the ground was used in common, the same station could be brought in by both sets simultaneously, but only about one-half as loud. In fact all stations were much fainter when the sets were so connected because they acted like shorts to each other.

In order to make it possible for others to duplicate these results, the following is a brief description of the tuning and detector units. It will be unnecessary to describe the amplifiers, as they are standard anyway.

The aerial or primary coil consisted of six turns of No. 22 S.C.C. wire on a 3½" cardboard tube 3" long. The secondary or grid inductance consisted of 50 turns of the same wire on the same tube and spaced about ¼" from it. This is the equivalent of the fixed coupler described by M. B. Sleeper. The secondary or grid inductance is tuned with a 23-plate condenser across it, while regeneration is obtained by the use of a standard plate variometer.

This arrangement gave sharp tuning from 215 to 600 meters, although regeneration was not effective about 400 meters without further loading the plate circuit or using a larger variometer than was then at hand. Nevertheless, the reception of local stations was all that could be asked for, under any circumstances.

The drawing, Fig. 1, shows the hook-up as used in both sets.

The points A and G represent the aerial and ground binding posts and indicate the points where the sets were connected. Diagrammatically indicating the coupling units and omitting the tuning, the sets were connected in the manner shown in Fig. 2.

No Matter What Your Vocation

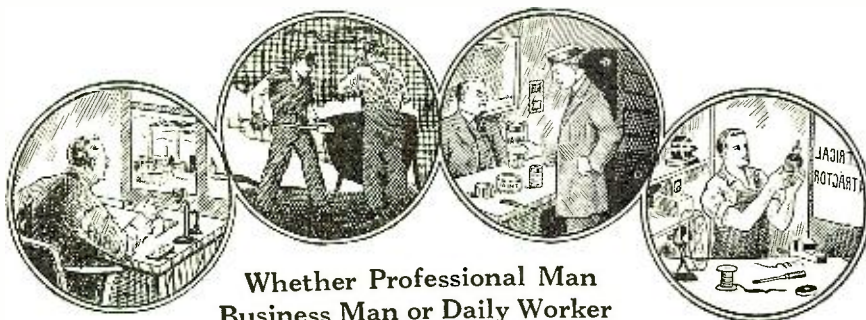

Whether Professional Man
Business Man or Daily Worker

A Thorough Training In CHEMISTRY Will Help You To Get Ahead

TO be successful today is to know Chemistry! Every line of business, every branch of industry depends upon Chemistry in some form. You may not realize it, but your own proficiency in whatever work you are doing would be increased by a knowledge of Chemistry. In many lines such knowledge is absolutely essential. In others it is a guarantee of promotion and more money.

The keen competition that exists in every commercial activity today requires that a man know all there is to know about his vocation. If you have something to sell—no matter what—Chemistry enters into its make-up. The salesman who knows the chemical composition of his article can talk about it more intelligently than the one who lacks this information, and his sales are proportionately larger. In the building trades Chemistry is of prime importance. The mason, electrician or painter who knows something about Chemistry can do better work and command more money than the one who does not. Through Chemistry a shop-keeper learns how to attract the most trade, and even in clerical positions one can capitalize his chemical skill.

Chemistry should be as much a part of your mental equipment as the ability to calculate or to write correct English. The world is paying a thousandfold more for ideas than for actual labor. The big rewards go to the man who can show how to turn out a little better product at a little lower cost. And Chemistry will give you the ideas that will save money for yourself or your firm in the very fundamentals of your business. There is nothing remarkable about this; it is going on every day. If you have not heard of it before, it is because the general public has been slow to recognize the tremendous value of chemical training. People have been content to leave Chemistry in the hands of a few trained chemists who could not possibly develop the subject to anywhere near its greatest extent.

Now we are on the eve of a great awakening. Our heritage from the World War has been an intense development of the chemical industries in the United States and a tremendous interest in all the applications of Chemistry. People are taking up the subject merely for the good it will do them in their own line of business.

It is no longer necessary to enter college in order to learn this fascinating science. Our Home Study Course trains you just as thoroughly, and with the same assurance of success, as those who took the longer way. And our methods are so simple that we can teach you no matter how little previous education you may have had. Many of our graduates now hold responsible positions or have materially increased their incomes from private enterprises as a result of taking our course. Hundreds of letters from students testifying to the benefits they have derived from our training are here for your inspection.

Remember that you do not need to study Chemistry with the idea of actually practicing as a chemist, although a great many of our students are taking our course with this object in view. If you want to know more about what Chemistry will do for you, if you want to know what our home study course offers, sign and mail the coupon today for FREE BOOK "Opportunities for Chemists."

Chemical Institute of New York, Inc.

HOME EXTENSION DIVISION 12

66-R West Broadway, New York City

**DR. T. O'CONOR SLOANE Will
Teach You Chemistry In
Your Own Home**

The Chemical Institute of New York, of which Dr. T. O'Conor Sloane is Educational Director, was founded to fill the need of ambitious, far-sighted men who realize and recognize the splendid future Chemistry offers them, but who cannot spare either the time or the money to attend college. Dr. Sloane, a foremost authority on Chemistry, will teach you and will give you any individual help you may require. He will personally go over your papers, correct them, point out your faults, teaching you in a practical and interesting way. No special education required other than the ability to read and write English. One student has characterized our lessons as "The course that takes the mystery out of Chemistry."

**Read What One of Our Recent
Graduates Reports**

"I thought I would let you know of my success. I finished your course about two months ago and now have a fine position as chemist at the DuPont Dye Works. I am getting along fine with my work and like it very much. It was through your course alone that I have been so successful. It is wonderful and I hope you have great success with it.

(Name and Address on request.)

Easy Monthly Payments

You do not have to have even the small price of the course to start. You can pay for it in small monthly payments—so small that you won't feel them. The cost is very moderate, and includes everything, even the Laboratory Equipment—there are no extras to buy with our course. Our plan of monthly payments places a chemical education within the reach of everyone.

**Laboratory Equipment Given
To Every Student Without
Additional Charge**

We give to every student without additional charge his chemical equipment, including forty-two pieces of laboratory apparatus and supplies, and seventeen different chemicals and reagents. These comprise the apparatus and chemicals used for the experimental work of the course.

Special 30-Day Offer

For a short period we are making a special offer that will be worth your while to take advantage of. Write for particulars, using the coupon below or simply a postal card. This will not obligate you in the least. Do not wait until to-morrow. Send the coupon now while you think of it.

**Sign and Mail the Coupon for
FREE BOOK**

CHEMICAL INSTITUTE OF NEW YORK, INC.

Home Extension Division 12,

66-R—West Broadway, New York City.

Please send me at once without any obligation on my part, your Free Book "Opportunities for Chemists," and full particulars about the Laboratory Equipment furnished to every student. Also please tell me about your plan of payment and your special 30 day offer.

NAME

ADDRESS

CITY

STATE

RN, 12-25.



The Only Tested Capacity Condenser



Erla bezels greatly enhance the finest cabinet assembly. Telescoping rim, in bright nickel or dull enamel, fits any $\frac{1}{8}$ " to $\frac{1}{4}$ " panel. List, 20c

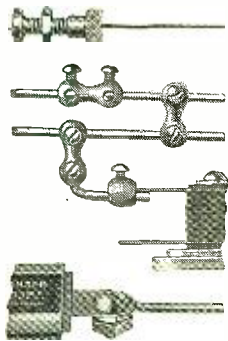

Difficult, dangerous use of soldering irons is eliminated by Erla solderless connections, saving time, temper and money. List, 5c ea.



Exquisite beauty is added to surpassing strength in Erla sockets, with triple-nickel metal parts on a polished Radion base. \$1 ea.

Dealers and Jobbers—Extra quality and value in Erla products assures maximum turnover and profits. Write for liberal terms and discounts

Erla fixed condensers are unique in that they are labeled "tested capacity," instead of "tested mica" or "tested condenser." Every Erla condenser is guaranteed to test to the exact capacity for which it is marked, an exclusive feature.

In fixed condensers, absolute accuracy is the foremost requirement. Innumerable instances of failure on the part of receiving apparatus to function properly can be traced directly to inaccurate condensers, varying sometimes as much as .001 microfarads.

In Erla fixed condensers, positively unvarying accuracy is assured by advanced laboratory and manufacturing methods developed and practiced exclusively by Erla. This selfsame accuracy also guarantees absolute noiselessness in each condenser, through maintenance of precisely uniform over-all pressure between plates.

Despite the unmatched quality and accuracy of Erla condensers, they cost no more than inferior types. In fact, savings in production resulting from Erla large scale manufacturing processes have enabled a material price reduction in some instances, as the following table will show:

Price	30c	35c	40c	65c	75c
Capacity	.0001	.0008	.0025	.005	.006
in	.00015	.001			
Microfarads	.00025	.0015			
	.00035	.002			
	.0005				

Sold by leading radio dealers in the United States and foreign countries. Or, write in direct, giving your dealer's name.

Electrical Research Laboratories
Dept. C 2515 Michigan Ave., Chicago

ERLA

In conclusion, it seems that the use of two or more sets of this type in a home would be almost ideal, because of the variety of the programs now broadcast and the diversity of tastes among the listeners-in even in the same household. There is no doubt in the writer's mind that it would be quite simple to make a set using two or more detector units that would be constantly tuned to two or three of the most popular stations, making it only necessary to plug in on the proper jack with phones or amplifiers and loud speaker, in order to get any one or all of these stations at one and the same time.

Solander's Radio Tomb

(Continued from page 696)

effect of letting his words slide out of his mouth and drip down his long chin like cold molasses, "but I have been making inquiries regarding you, and I have been meaning to speak to you. I am drawing up a new last will and testament, and I want you to draw up one of the clauses for me."

"Why, certainly, Mr. Solander," I said with increased pride. "I'll be glad to be of service to you."

"I am choosing you for the work," Remington Solander said, "because you know and love radio as I do, and because you are a trustee of the cemetery association. Are you a religious man?"

"Well," I said, a little uneasily, "some. Some, but not much."

"No matter," said Mr. Solander, placing a hand on my arm. "I am. I have always been. From my earliest youth my mind has been on serious things. As a matter of fact, sir, I have compiled a manuscript collection of religious quotations, hymns, sermons and uplifting thoughts which now fill fourteen volumes, all in my own handwriting. Fortunately, I inherited money, and this collection is my gift to the world."

"And a noble one, I'm sure," I said.

"Most noble," said Mr. Solander. "But, sir, I have not confined my activities to the study chair. I have kept my eye on the progress of the world. And it seems to me that radio, this new and wonderful invention, is the greatest discovery of all ages and imperishable. But, sir, it is being twisted to cheap uses. Jazz! Cheap songs! Worldly words and music! That I mean to remedy."

"Well," I said, "it might be done. Of course, people like what they like."

"Some nobler souls like better things," said Remington Solander solemnly. "Some more worthy men and women will welcome nobler radio broadcasting. In my will I am putting aside one million dollars to establish and maintain a broadcasting station that will broadcast only my fourteen volumes of hymns and uplifting material. Every day this matter will go forth—sermons, lectures on prohibition, noble thoughts and religious poems."

I assured him that some people might be glad to get that—that a lot of people might, in fact, and that I could write that into his will without any trouble.

"Ah!" said Remington Solander. "But that is already in my will. What I want you to write for my will is another clause. I mean to build, in your cemetery, a high-class and imperishable granite tomb for myself. I mean to place it on that knoll—that high knoll—the highest spot in your cemetery. What I want you to write into my will is a clause providing for the perpetual care and maintenance of my tomb. I want to set aside five hundred thousand dollars for that purpose."

"Well," I said to the sheep-faced millionaire, "I can do that, too."

"Yes," he agreed. "And I want to give to

14 RADIO FORMULAE AND DIAGRAMS FOR 50c.

PARTIAL CONTENTS



Measurement of Capacity of a Condenser. Two Methods. Two Diagrams.
Measurement of Inductance of a Coil or Circuit. Two Methods. Two Diagrams.
Measurement of Distributed Capacity of an Inductance. Diagram and Curve.
Measurement of Fundamental Wavelength of an Antenna. Three Methods. Three Diagrams.
Measurement of Wavelength of Distance Transmitting Station. Two Methods. Calibration of a Receiving Set. Two Diagrams.
Measurement of Effective Antenna Capacity. Two Methods. Two Diagrams.
Measurement of Inductance of Antenna and a Third Method of Measuring Effective Capacity of Antenna.
Measurement of Antenna Resistance. Substitution Method.

With this packet of radio knowledge you need never worry about schematic wiring diagrams, measurements and radio tables. All formulas and diagrams are printed on heavy paper in black and blue, and contained in two-color printed envelope, 9x12 in.

FOR SALE AT ALL DEALERS

THE CONSRAD COMPANY, INC.

233 Fulton Street

New York City

my family and relations the remaining million and a half dollars, provided," he said, accenting the "provided," "they carry out faithfully the provisions of the clause providing for the perpetual care and maintenance of my tomb. If they don't care and maintain," he said, giving me a hard look, "that million and a half is to go to the Home for Flea-Bitten Dogs."

"They'll care and maintain, all right!" I laughed.

"I think so," said Remington Solander gravely. "I do think so, indeed! And now, sir, we come to the important part. You, as I know, are a trustee of the cemetery."

"Yes," I said, "I am."

"For drawing this clause of my will, if you can draw it," said Remington Solander, looking me full in the eye with both his own, which were like the eyes of a salt mackerel. "I shall pay you five thousand dollars."

Well, I almost gasped. It was a big lot of money for drawing one clause of a will, and I began to smell a rat right there. But, I may say, the proposition Remington Solander made to me was one I was able, after quite a little talk with my fellow trustees of the cemetery, to carry out. What Remington Solander wanted was to be permitted to put a radio loud-speaking outfit in his granite tomb—a radio loud-speaking outfit permanently set at 327 meters wave-length, which was to be the wave-length of his endowed broadcasting station. I don't know how Remington Solander first got this remarkable idea, but about that time an undertaker in New York had rigged up a hearse with a phonograph so that the hearse would loud-speak suitable hymns on the way to the cemetery, and that may have suggested the loud-speaking tomb to Remington Solander, but it is not important where he got the idea. He had it, and he was set on having it carried out.

"Think," he said, "of the uplifting effect of it! On the highest spot in the cemetery will stand my noble tomb, loud-speaking in all directions the solemn and holy words and music I have collected in my fourteen volumes. All who enter the cemetery will hear; all will be ennobled and uplifted."

That was so, too. I saw that at once. I said so. So Remington Solander went on to explain that the income from the five hundred thousand dollars would be set aside to keep "A" batteries and "B" batteries supplied, to keep the outfit in repair, and so on. So I tackled the job rather enthusiastically. I don't say the five thousand dollar fee did not interest me, but I did think Remington Solander had a grand idea. It would make our cemetery stand out. People would come from everywhere to see and listen. The lots in the new addition would sell like hot cakes.

But I did have a little trouble with the other trustees. They balked when I explained that Remington Solander wanted the sole radio loud-speaking rights of our cemetery, but someone finally suggested that if Remington Solander put up a new and artistic iron fence around the whole cemetery it might be all right. They made him submit his fourteen volumes so they could see what sort of matter he meant to broadcast from his high-class station, and they agreed it was solemn enough; it was all solemn and sad and gloomy, just the stuff for a cemetery. So when Remington Solander agreed to build the new iron fence they made a formal contract with him, and I drew up the clause for the will, and he bought six lots on top of the high knoll and began erecting his marble mausoleum.

For eight months or so Remington Solander was busier than he had ever been in his life. He superintended the building of the tomb and he had on hand the job of getting his endowed radio station going—it was given the letters WZZZ—and hiring artists to sing and play and speechify his fourteen

18 Stock Sizes		
Radion Panels		
6 x 7	7 x 21	
6 x 10½	7 x 24	
6 x 14	7 x 48	
6 x 21	9 x 14	
7 x 9	10 x 12	
7 x 10	12 x 14	
7 x 12	12 x 21	
7 x 14	14 x 18	
7 x 18	20 x 24	

The Supreme Insulation

RADION Panels

**are easiest
to drill, saw
or engrave
with simple
tools at
home**

American Hard Rubber Co.
11 Mercer Street, New York.

RADION

Panels ~ Dials ~ Knobs ~ Sockets ~ Insulators

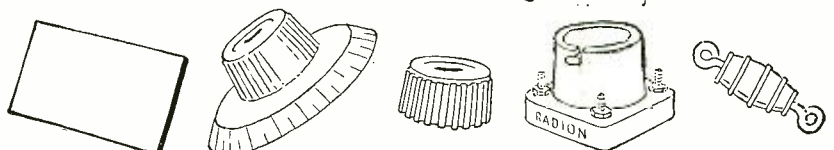

You Must See

this wonderful instrument to realize its beauty, its perfection in design and workmanship. You will have to listen to the beautiful programs which may be brought to your home by its use before you realize what "SERVICE" means.

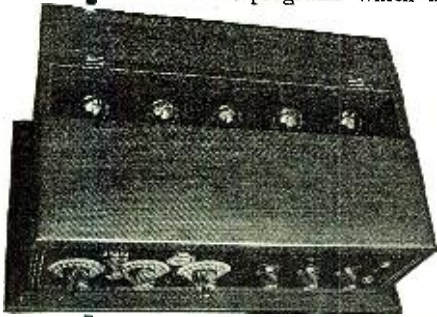

SERVICE TYPE 212 Receiving Set with folding loop antenna, f.o.b. Cincinnati, O. **\$150⁰⁰**



Dealers, are you furnishing your customers with "SERVICE"?

Write for booklets.



This is a TELEFORCE product.

4733 Montgomery Road

CINCINNATI, OHIO

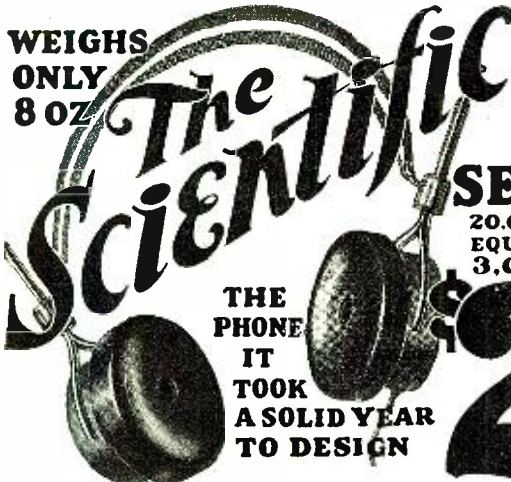

WEIGHS ONLY 8 OZ

A \$200,000.00 COMPANY stands squarely back of the guarantee on every Scientific headset

SEND NO MONEY!

20,000 TURNS EQUIVALENT TO 3,000 OHMS

Order TODAY by Postcard and Pay Postman on arrival

\$2.95

POST-PAID

LOUD SPEAKER UNIT \$1.95

THE PHONE IT TOOK A SOLID YEAR TO DESIGN

We Guarantee The Scientific Headset to be the greatest value on the market. Try it for five days. If not satisfactory send it back and your money will be refunded immediately. Circular on request. Dealers wanted.

THE SCIENTIFIC ELECTRIC WORKS

98 Brookline Ave. DEPT. H. BOSTON, MASS.

NAZELEY'S

PORTENA

FOLDING LOOP

(PATENT PENDING)

SPREAD, 28 inches.

GENUINE BAKELITE FACINGS; 85 FT. GREEN COVERED WIRE; MOROCCO FINISHED CASE.

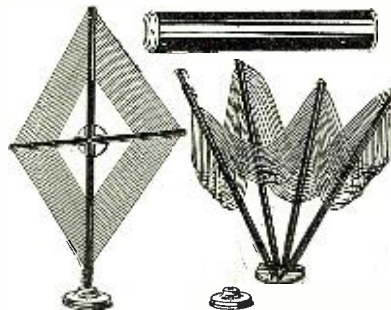

PRACTICAL—EFFICIENT—PERFECT

RICH MAHOGANY FINISH

FOLDS UP LIKE AN UMBRELLA; WORKS LIKE A CHARM.

In individual Morocco covered Tube

LIST \$6.50 EACH

One dozen to a Case

J. NAZELEY CO., 571 Hudson St., New York City

volumes of gloom and uplift at 327 meters, and it was too much for the old codger. The very night the test of the WZZZ outfit was made he passed away and was no more on earth.

His funeral was one of the biggest we ever had in Westcote. I should judge that five thousand people attended his remains to the cemetery, for it had become widely known that the first WZZZ program would be received and loud-spoken from Remington Solander's tomb that afternoon, the first selection on the program—his favorite hymn—beginning as the funeral cortege left the church and the program continuing until dark.

I'll say it was one of the most affecting occasions I have ever witnessed. As the body was being carried into the tomb the loud-speaker gave us a sermon by Rev. Peter L. Ruggus, full of sob stuff, and every one of the five thousand present wept. And when the funeral was really finished, over two thousand remained to hear the rest of the program, which consisted of hymns, missionary reports, static and recitations of religious poems. We increased the price of the lots in the new addition one hundred dollars per lot immediately, and we sold four lots that afternoon and two the next morning. The big metropolitan newspapers all gave the Westcote Cemetery full page illustrated articles the next Sunday, and we received during the next week over three hundred letters, mostly from ministers, praising what we had done.

But that was not the best of it. Requests for lots began to come in by mail. Not only people in Westcote wrote for prices, but people away over in New Jersey and up in Westchester County, and even from as far away as Poughkeepsie and Delaware. We had twice as many requests for lots as there were lots to sell, and we decided we would have an auction and let them go to the highest bidders. You see, Remington Solander's Talking Tomb was becoming nationally famous. We began to negotiate with the owners of six farms adjacent to our cemetery; we figured on buying them and making more new additions to the cemetery. And then we found we could not use three of the farms.

The reason was that the loud speaker in Remington Solander's tomb would not carry that far; it was not strong enough. So we went to the executors of his estate and ran up against another snag—nothing in the radio outfit in the tomb could be altered in any way whatever. That was in the will. The same loud speaker had to be maintained, the same wave-length had to be kept, the same makes of batteries had to be used, the same style of tubes had to be used. Remington Solander had thought of all that. So we decided to let well enough alone—it was all we could do anyway. We bought the farms that were reached by the loud-speaker and had them surveyed and laid out in lots—and then the thing happened!

Yes, sir, I'll sell my cemetery stock for two cents on the dollar, if anybody will bid that much for it. For what do you think happened? Along came the Government of the United States, regulating this radio thing, and assigned new wave-lengths to all the broadcasting stations. It gave Remington Solander's endowed broadcasting station WZZZ an 855-meter wave-length, and it gave that station at Dodwood—station PKX—the 327-meter wave-length, and the next day poor old Remington Solander's tomb poured forth "Yes, We Ain't Got No Bananas" and the "Hot Dog" jazz and "If You Don't See Mama Every Night, You Can't See Mama At All," and Hink Tubbs in his funny stories, like "Well, one day an Irishman and a Swede were walking down Broadway and they see a flapper coming towards them. And she had on one of them short skirts they was wearing, see? So Mike he says 'Gee, be jabers, Ole, I see a peach.'

So the Swede he says, lookin' at the silk stockings, 'Mebby you ban see a peach, Mike, but I ban see one mighty nice pair.' Well, the other day I went to see my mother-in-law—"

You know the sort of program. I don't say that the people who like them are not entitled to them, but I do say they are not the sort of programs to loud-speak from a tomb in a cemetery. I expect old Remington Solander turned clear over in his tomb when those programs began to come through. I know our board of trustees went right up in the air, but there was not a thing we could do about it. The newspapers gave us double pages the next Sunday—"Remington Solander's Jazz Tomb" and "Westcote's Two-Step Cemetery." And within a week the inmates of our cemetery began to move out. Friends of people who had been buried there over a hundred years came and moved them to other cemeteries and took the headstones and monuments with them, and in a month our cemetery looked like one of those Great War battlefields—like a lot of shell-holes. Not a man, woman or child was left in the place—except Remington Solander in his granite tomb on the top of the high knoll. What we've got on our hands is a deserted cemetery.

They all blame me, but I can't do anything about it. All I can do is groan—every morning I grab the paper and look for the PKX program and then I groan. Remington Solander is the lucky man—he's dead.

Simplifying Amplifier Construction

(Continued from page 709)

sults were gratifying considering the fact that no audio frequency amplification or regeneration was used. When the output was passed through two audio stages to the Magnavox the volume was unbearable nearby, very pleasing one block away, and still discernible at a distance of three blocks.

The full test of the set will come with the keen winter weather when it is expected to receive the broadcasting stations as well as amateur code stations on the Pacific coast from the Atlantic seaboard.

The Dope on the Second National A. R. R. L. Convention

(Continued from page 706)

quite bashful, contrary to all reports of his examinees, (Couldn't face his victims. Hi!) and wouldn't speak, so Mr. Beane who is the executioner in the ninth district was called on next. He was at a table of Second District hams (Safety first? ?). He gave us a first-class brass-pounder talk that warmed all of us pleasantly. By the way, he said that he had a hock-up that would work FB on the waves below 200 meters for transmission.

Then amid enthusiastic applause, Schnell, our traffic manager arose to give us the razz for our bum traffic handling, and vice versa. He also introduced all the division managers whom the gang were surely glad to see, having been under their thumb for so long. The Canadian manager was also introduced.

The applause following Schnell's talk had hardly subsided when it was resumed with violence on the introduction of our international friend, Delcy. Delcy entered a special plea for clear sending of call signals and

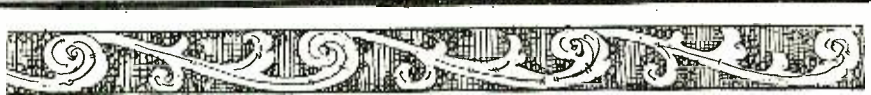

The New



Radio Frequency Unit

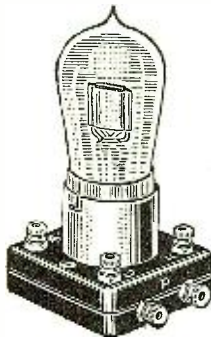

Radio Frequency Unit
\$3.50

Type R U-1 has nothing to equal it in efficiency, design and amplification.

The very latest design in radio frequency Amplifier—reduces capacity effect to a minimum—short leads (not necessary to be longer than one inch.) Units can be placed close together when two or more stages are used. Handsomely finished in black and polished nickel—2 1/4" square.

United Radio Frequency Transformer

200-600 meters. It has an air core and impregnated windings. Can be used for table panel or socket mounting. It has a highly polished nickel finish—with black ends. Gives excellent results with any standard radio frequency, Reflex, Inverse Duplex or Neutrodyne Circuits.

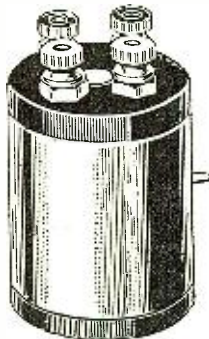

Radio Frequency Transformer
\$2.50

United Audio Frequency Transformer

Made in two ratios: A-1—5 to 1. A-2—3.5 to 1. Finished in black with nickel trim. For one, two or more stages of Audio-Frequency amplification.

United Mfg. & Distributing Co.,

9701 COTTAGE GROVE AVENUE - CHICAGO

New York Office: 50 Church St., New York City

San Francisco Office: 709 Mission Street, San Francisco, Calif.

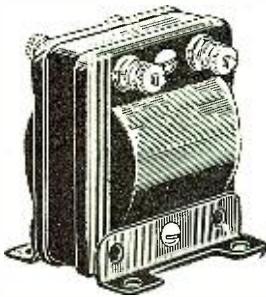

Audio Frequency Transformer
\$4.50

United Condensers

Both Vernier and Plain

United Condensers have become the standard condensers through their unequalled performance in all circuits.

PLAIN without dial or knob		
Plates	Max. Cap.	Price
43	.001 mfd.	\$4.00
22	.0005 mfd.	3.50
11	.00025 mfd.	3.00
5	.00013 mfd.	2.50
3	.00008 mfd.	2.25
VERNIER with dial and knob		
Plates	Max. Cap.	Price
43	.00108 mfd.	\$6.50
23	.000508 mfd.	5.50
11	.000258 mfd.	5.00

Write for complete catalog of United Quality radio Products. Tells how to make a power amplifier out of an audio Transformer.



Vernier Condenser





It's Fun to Fish for Fish — BUT

fishing for a spot on your detector is no pleasure at all

The GREWOL

Fixed Detector



is *always* set and ready for use. Re-adjustment seldom required—and then made in a moment. The most satisfactory, always sensitive, guaranteed detector. At your dealer's or direct upon receipt of \$2.00.

Widely Approved
Certificate of Merit By
JACK BINNS
Radio Editor of the N. Y. Tribune

LIST
\$2.00

Write for free booklet with new reflex hookups.

RANDEL WIRELESS CO.
11 Central Avenue - Newark, N. J.

RADIO NEWS says:
"We found this detector very sensitive and also found that it holds its adjustment."

OUR BEST ENDORSEMENT EVERY GREWOL USER.

a general fist improvement. Remember that! After hearing this, every ham with five watts or more was in hopes of reaching him and it is rumored that some of the single circuit BCL's are grooming their sets for the next trans-atlantics!

The night finished happily with a few more orchestra selections and more singing. I was tired, but full and happy and sleepy.

THE THIRTEENTH

On Thursday all those who had recovered sufficiently from the effects of the banquet of the night before, assembled once more at the Edgewater Beach Hotel and by means of auto buses were given a ride through parts of Chi and conducted through a couple of broadcasting stations. The gang with their whistles and code almost stopped traffic, they attracted so much attention.

We saw WDAP which is SOME station, and the "Ohs" and "Ahs" of the gang showed that they were duly impressed. WDAP has a variocoupler wound with 3/4" copper tubing. GEE!!!! We next saw the station at the LaSalle Hotel which is a W.E. and a whiz too. It is stuck 20 stories up in the air and has some steel towers to boot.

After the run around town to the stations we were headed back to the Edgewater for a few prize contests. These were really



New!

The PUDLIN

FIXED GRID LEAK

Made by an entirely New Process. More durably and carefully Hand made to last Years—and Guaranteed 1/10 rated Capacity.

PRICE 25c
We also manufacture the celebrated Arthur Pudlin Variable High Resistance Leak. Price with .00025 Condenser \$1.00
Without Condenser \$0.75

Pudlin Eng., Co., Inc. 110 W. 40th St., N.Y.C.

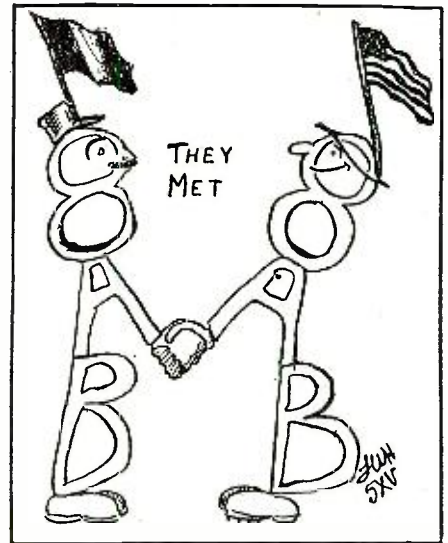
It Took Them a Long Time to Extend Their Best by Word of Mouth, But the Expectation Was Worth Something.

amusing: a bunch tried to eat 10 very dry soda crackers, and then whistle, doing it before any one else could. Many of the crowd watching were gasping for breath as they laughed while the contestants were gasping for another reason, quite. This side bruiser was not sufficient it seemed, so a radio liars' contest was next held that was stunning in its audacity. K. E. Hassel won the prize and then had the nerve to give a technical talk. We wonder? Sidesore but happy we beat it home at the conclusion and cleaned and dressed and ate in preparation for a good night.

At seven-thirty the whistles and general pandemonium announced the arrival of the "Awful Racket Raisers' League" at the Nicholas Senn High School where the technical talks were to be given. The first speaker, introduced by Matty, as usual, was Clausung, of the Chicago Radio Laboratory, who gave a first-rate discussion of transmitters and their design; also antennae. He provoked over an hour's discussion which turned up many interesting facts. Notebooks and pencils were busy on every side. After most of the Clausung discussion was finished, 5ZC caused quite a commotion when some portly

WANTED

Complicated Hook-ups!

To simplify difficult hook-ups use "Read 'em" Binding Posts. Tell at a glance whether it is Antennae, Ground, Fones, A or B battery, etc. Name neatly engraved for keeps on top of each post. (See illustration). The irremovable knobs save time, trouble and petty annoyances. "Read 'ems" add to the appearance of any set. Don't be without them. Price 15c each. Set of ten (as shown) \$1.50.

If your dealer can't supply you with "Read 'ems," order direct.

Look for the name "Read 'em" on every post.

The Marshall-Gerken Co.

Dept. A 27 N. Ontario St. Toledo, Ohio

"Read 'em" Binding Posts



The Marshall-Gerken Co. Toledo, Ohio

colored lady (?) entered, real wrathful, with a pickaninny and centered him out demanding quite wrathfully that he "suppo't his lil' chile an' prepah wife. Wharfo did he mean desertin' a dependan' and trustin' woman in 'at mannah!'" ZC denied nothing, so he left us up in the air. A couple of valorous nines, almost wrecked, finally persuaded the portly apostle of right to leave: she did, vociferous and angry. It is suggested that ZC give up radio and pay some attention to his family. Hi!

Following Clausing, amateur number one, Vermilya, 1ZE, friend of everyone and a real ham, got up and gave us an amusing and interesting description of his wonderful ether buster that melts the plating off his antenna with 25 amperes. He had a method of buying a young forest for a few dollars that amused everyone mightily, so it is no wonder that 1ZE has a couple of real poles.

After him the Dubilier representative gave an interesting history and description of the condenser. Mr. R. H. Cunningham gave this in the absence of Mr. Dubilier.

On Cunningham's conclusion we heard from our old friend Prof. Jansky. He spoke on the relation of the amateur and the BCL, on interference, and on range phenomena or the performance of transmitters at a distance. His data, actually obtained from facts, proved the amateur to be the cause of the least interference and was received with much applause. Unfortunately he didn't get to say half enough because of lack of time.

The next speaker caused an ovation on his introduction, French 8AB. He gave some interesting data on the receiver he was using and caused much rustling of paper as the gang found that they needed their notebooks. Luckily, he just about finished when the lights went out, so that we were almost satisfied, although we had wished to hear about his transmitter. So amid whistles of FB and tremendous applause, F-AB left and so did we, tired and contented.

THE FOURTEENTH

In the morning the division managers and the traffic manager held a confab that must have been very vigorous. At any rate it had to be postponed until midnight, so you can imagine. Wish I'd been there. At any rate, around noon or so, we, the gang, had our confab with our traffic manager, Schnell, and a long, interesting, and amusing discussion followed that will surely result in the general improvement of our message service and stations. This finished around 5:30, when some of the gang went to Elgin to see the excellent broadcasting station located there: the rest stayed at the Edge-water to see some exhibition diving. Then we separated to go home for a few minutes, and eat, in preparation for the night's events.

When 7:30 came, the Nicholas-Senn was again alive with hams and whistle-code. Another series of technical talks took place.

H. J. Marks, the first speaker (yep, Matty was introducer), pleased everyone with his excellent viewpoint on the BCL and ham relations. Hope his ideas become quite general. All applauded him generously.

Following him was C. D. Tuska, the speed-demon according to newspaper reports, and the ham's original friend. Pencils and notebooks were at their very busiest when he told about and gave data on the new wonder circuit, the Miner. I suppose it will be known as the 1RU which is Miner's call. C. D. says it is very difficult, so it is only another worry to help the ham along the road to the insane asylum,

*Less Distributed Capacity,
No Distortion. 40% More Amplification
because*

Samson
HW-A1
AUDIO FREQUENCY
Transformer has

HELICAL WOUND COILS



Radio set owners all over the country have learned that SAMSON Transformer superiority proves out under actual operating conditions. Here's an extract from a letter by an authority: "*The Samson Electric Company have apparently 'rung the bell' with their transformer. Several of the men here in headquarters and one or two commercial radio laboratory experts have had occasion to use and test out the transformer and they are all very high in their praise of it.*"

Helical Windings in BOTH primary and secondary coils have revolutionized transformer efficiency. And *only* Samson Transformers can have Helical Wound Coils.

Helical Winding lays the wire in layers at right angles to the core. Adjacent wires are fewer turns apart; consequently the electrical pressure is less and capacity effect is reduced to a minimum.

To make your set operate at its best use SAMSON Transformers. Write for Report No. 23 and Chart of Tests.

Ratio: 6 to 1
Price \$7 at dealers

Made by
SAMSON ELECTRIC COMPANY

Factory: CANTON, MASS.

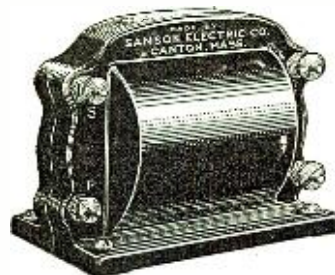

Sales Offices: Boston, New York, Philadelphia, Pittsburgh, Chicago, Cleveland, Detroit, Indianapolis, St. Louis, Minneapolis, San Francisco, Los Angeles, Seattle, Portland, Montreal and Toronto

JUST THE BOOK YOU WANTED

"RADIO NEWS"
Amateurs' Handibook

Volume No. 1

Check full of radio constructive and instructive articles from cover to cover. Written by foremost radio authorities, in plain everyday language which everyone can understand. Sections include articles on Receiving Sets and Sundry Apparatus, Transmitters and Accessories, Radio Theory, Vacuum Tube Data, and Practical Hints for the Amateur. A book which also serves as a ready reference and should find a place in the library of every amateur. It contains 224 pages and over 375 illustrations, diagrams, and photographs, bound in a multi-colored heavy board.

On sale at all leading radio stores. If your dealer cannot supply you, pin a dollar bill to this ad and write your name and address in the margin below, and book will be forwarded to you postpaid. **PRICE, \$1.00.**

EXPERIMENTER PUBLISHING CO., Inc.
53 Park Place, New York.

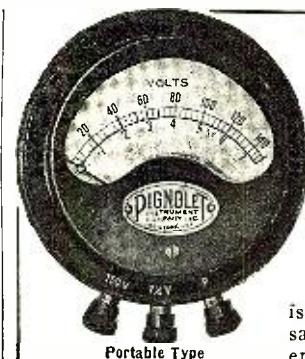

**Reduce
Cost of
Operating
Your
Radio Set**

**Pignolet
Radio
Voltmeter**

is essential to
satisfactory operation.

Portable Type

Write for booklet.

PIGNOLET INSTRUMENT CO., INC.
114 Liberty Street New York City

Announcing "The Latest Creation in Radio"

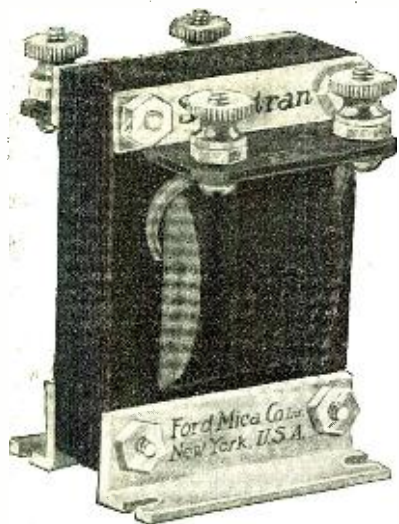

The "SUPERTRAN"

F. M. C. Audio
Frequency Transformer

Has no equal on the market for

**EFFICIENCY
QUALITY
PRICE**

Report of laboratory test made by the well-known New York Radio Engineer and Inventor, LESTER L. JONES, sent upon request.

Jobbers, Dealers and Manufacturers write for our proposition and prices.

Manufactured by

FORD MICA COMPANY, Inc.

14 Christopher Street

New York City, N. Y.

LEARN THE CODE AT HOME

"Just Listen—The Omnigraph will do the teaching"

with the

OMNIGRAPH

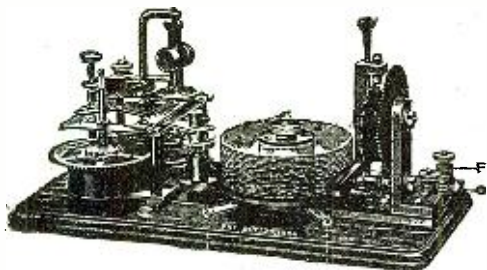

THE **OMNIGRAPH** Automatic Transmitter will teach you both the Wireless and Morse Codes—**right in your own home**—quickly, easily and inexpensively. Connected with Buzzer, Buzzer and Phone or to Sounder, it will send you unlimited messages, at any speed, from 5 to 50 words a minute.

THE **OMNIGRAPH** is not an experiment. For more than 15 years, it has been sold all over the world with a money back guarantee. The **OMNIGRAPH** is used by several Depts. of the U. S. Govt. all applicants applying for a Radio license. The **OMNIGRAPH** has been successfully adopted by the leading Universities, Colleges and Radio Schools.

—in fact, the Dept. of Commerce uses the **OMNIGRAPH** to test all applicants applying for a Radio license. The **OMNIGRAPH** has been successfully adopted by the leading Universities, Colleges and Radio Schools.

Send for **FREE** Catalog describing three models, \$14 to \$30. **DO IT TODAY.**

The Omnigraph Mfg. Co., 20 Hudson St., New York City

If you own a Radio Phone set and don't know the code—you are missing most of the fun

Increase your Range

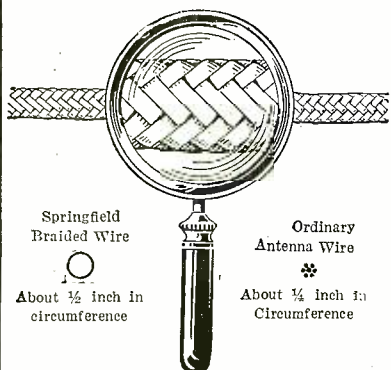

Springfield
Braided Wire
About 1/2 inch in
circumference

Ordinary
Antenna Wire
About 1/4 inch in
Circumference

15 to 100%. You can, with your present equipment, by using **SPRINGFIELD 16-STRAND BRAIDED ANTENNA.**

125 feet in your attic, in strands 3 feet apart, gives better results than 150 feet of ordinary wire outdoors.

Most wonderful wire for indoor loops. Its extra large surface—twice that of ordinary wire—enables you to get greater distance and clearness. *Write for free booklet.*

At dealers—or send us \$2.50 for 100 feet.
Dealers and Jobbers—write for prices and terms.

SPRINGFIELD WIRE & TINSEL CO.

67A Taylor St., Springfield, Mass.

Springfield 16 Strand Braided Antenna

not to mention the poorhouse. It is also called the Superdyne, to be in style. He provoked much interest and discussion, so had to be retired amid a thunder of applause.

Then one of the best talks we had was given by Mr. Miller of the Jewell Electric Co., who, with a mammoth testboard and special size meters, described the method of measuring tube constants, and demonstrated, giving data on one tube and furnishing cross-section paper to us so that we could draw our own curve. Believe us, he left an enthusiastic and appreciative audience. Thanks, Mr. Miller.

Then came another of the fine talks this evening gave forth; the talk by Mr. J. C. Warner of the G. E. Laboratories, on the new X-L filament in a new series of transmitting tubes. He showed a UV No. 204-A and a UV No. 203-A, 250 and 50-watt tubes respectively, although their output is higher than their ratings. He broke one of the 50-watters to show its inside construction and caused much groaning and excitement in the audience. His talk was valuable.

Mr. Warner was interrupted several times by small commotions. The gang that went to Elgin returned and did a snake dance through the audience and upon the stage where they gave a yell and introduced a new organization that they had formed, the Royal Order of Suckers. Matty was made the Grand Windjammer of the organization and was presented with a big new and wrapped all-day-sucker, which he immediately devoured. The excitement of that had hardly subsided when one of the ops from 9ZY was taken in charge by a cop, as a full quart of bootleg was found on him. He never came back and it took the combined counsel of the League to save his hide.

K. E. Hassel of the Chicago Radio Laboratory, next gave us some real dope on a receiving set and the general design. Notebooks were again busy, this was valuable.

Ross Gunn next gave us a very rapid talk on antennae, so that he might cram all into it possible in the time allowed. He is a bear for cages so that still remains the last word.

As the concluding number on an especially valuable evening, 9CSR, Olsen, gave a talk on the new Balkite Rectifier and how to use it. He gave practical dope on an amateur installation. His talk was illustrated by slides and drawings and only concluded when the lights went out. Thus the evening ended at its best.

SATURDAY, THE DAY FOR SK es CUL

The fifteenth started off right! The sparks and C.W.'s had a first class indoor baseball game that was full of action. They, the sparks, reversed the tug-of-war result and won, leaving the C.W. gang in ignominy. 1ZE, captain of the C.W.'s, promised thorough vengeance.

Then the afternoon's events started with a group photograph which almost wrecked a good camera. It was sturdily built though and stood the awful strain. Then came the real side-buster, the Radio Stunt Party. First of all every ham got out pencil and paper so that he could get a signature from one man of every district, Canada and France. The first to get a complete list was to be awarded a prize. There was some real scrambling and it looked more like a milling contest, though everything was good natured. It ended in great excitement and amusement.

When enough quiet had been restored to allow a yell to be heard, Marco, who was conducting the party, announced the next event, the Wild Acrobatic Headphone contest. Each contestant was provided with a pair of headphones with the cord wound

carefully: the idea was to unwind them, put them on your head and have them straight before anyone else, and with one hand, the other being kept in the pocket. The efforts and antics of the contestants kept everyone laughing and gasping, and it was a sight worth seeing. There were several heats and several winners as a result. After the headphone business had been settled, we had another just as funny.

Two hams were given a roll of wire, one at each end, and told to unwind and rewind new coils, the largest and neatest of which to be first to finish was to win a prize. There were several couples so the excitement and tangles ran high. Kruse, Deloy and Corlett judged the contests.

Next came the loop contest. WDAP loaned us the receivers, the C. S. Tay Sales Co. the crystals, and the loops were home-made. There were two hams to the receiver and everyone scattered to hunt for the hidden spark transmitter. We almost stopped traffic and I'll bet many a Chicagoan had a sore neck trying to see all he could. We were stopped by several curious ones. The thing was finally found after a long and amusing search during which, many never heard the transmitter. Thirteen prizes were awarded to the thirteen first to find the transmitter.

After this we went back to the hotel and the prize winners got in line for their prizes. There were so many for the duration of the convention that it is impossible to give them all. The manufacturers were very, very generous.

Then came the best of them all, the night mystery. We assembled at the Sheridan-Plaza Hotel and from there were taken, in buses, to the mysterious location of the night's happenings. We went quite a distance, too, and were then conducted into a large and beautiful banquet hall. Here, things soon started (not speaking of the whistles which were very prevalent) and the announcement of the dread initiation into the Royal Order of The Wouff Hong and the revelation of its awful mysteries, was made. Unfortunately there was too big a crowd for individual initiations, so 5ZC was chosen to represent the crowd and go through the ceremony. It is secret of course, so we cannot bare the facts of what occurred, but all got some good laughs. The Flint, Michigan, bunch are to be complimented in their excellent invention, for they evolved the organization in its entirety. It was an impressive and amusing ceremony. After ZC's suffering ended, R. H. G. Matthews, Keeper of the Royal Parchment, was allowed to relieve himself of the responsibility and put it on some initiate. So he turned it over to K. B. Warner who was required to open it and show the members that it was safe. The parchment caused the biggest roar of laughter yet; it came in two rolls, five cents each. Then we ate. There were sandwiches, olives, pickles, near-beer, and other drinks and plenty for all, but some rush, nevertheless. The Chi. Committee knew what we wanted, for they provided a good and shapely chorus that gave us some real eye and ear entertainment to the satisfaction of all, though they wanted more.

The big excitement of the night though came on the drawing for the Zenith complete set, donated by the Chicago Radio Laboratory. This had hardly gone to its owner when the Grebe representative donated one of their new receivers, the CR-13, 80 to 300 meters, a real ham set, for the same purpose. Excitement ran high and then overflowed when a four-tube radio frequency set was donated by the Western Coil Company, and the drawings were made. The bunch went home happy, tired, and



You Double the Fascination of Radio

when you *build your own set*. You find it comparatively easy to equal and usually surpass the best results from your neighbors' expensive ready made sets. And what a thrill to reach out hundreds of miles across hill, stream and mountain range perhaps and bring in the distant stations in full, rich volume. All this with your own personal set! It's a triumph you'll talk about.

Coto for Efficiency, for Compactness, for Value



New Coto Compact Moulded Variometer
Size only 3 1/4 x 1 3/4 x 3 3/4. In moulded bakelite. Stator is honeycomb wound. Range 200 to 600 meters. Base or panel mount.
Type 8000\$5.00



New Coto Compact Variocoupler
Companion piece of the Variometer. Size only 3 1/4 x 3 x 3 3/4 in. Range 200 to 600 meters. Base or panel mount.
Type 9000\$5.50



Coto Special Audio Frequency Transformer
Turn ratio of 3 to 1. Coto quality throughout but made to sell at a popular price.
Type 4500\$2.50



The Original Honeycomb Wound Inductance Units
Popular low priced favorites of the amateur and experimenter. Allow easy variation of coils to get all wave-lengths. Sold mounted or unmounted.



Coto Tapped Radio Frequency Transformer
Efficiently covers the whole broadcasting range because it is tapped. Just work the switch.
Type 5000A\$7.50



New Coto Compact Air Condenser with Vernier
Just as rugged and efficient as it looks and only 2 7/8 inches square on the panel. Constructed on a metal base for rigidity. Insulated with scientific care. Stator plates are soldered to three posts for rigidity and low losses. Rotor plates soldered to shaft. Built right to serve you many years.
Type 3505 \$5 .0005 Mfd. Type 3510 \$6 .001 Mfd.

Reliable Dealers Always Recommend Coto Quality

Dealers value the trade of those who insist on Coto Quality. If your dealer fails you, send us his name and we will see that you are supplied.

Coto-Coil Co.
87 Willard Ave.
Providence, R. I.

Pacific Coast Branch,
329 Union League Bldg., Los Angeles, Cal.
Northwestern Branch,
Geo. F. Darling, 705 Plymouth Bldg.,
Minneapolis, Minn.
Southeastern Branch,
C. P. Atkinson, Atlanta Trust Co. Bldg.,
Atlanta, Ga.

Federal Variometer No. 90 Cuts Electrical Leaks to the Minimum

INSTEAD of the usual large amount of molded insulation, six small strips of Bakelite support the coils of this perfected variometer. This construction reduces even the very small leak of current from the coils, and materially increases the efficiency of the unit.

Though very light, the various parts act as trusses, giving a rugged unit which will stand up under rough treatment.

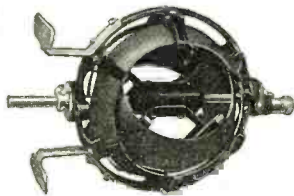

Federal Radio Equipment

130 Federal Standard Radio parts offer the radio enthusiast a complete line of guaranteed parts of one quality—the best.

Federal Telephone and Telegraph Company

FACTORY: BUFFALO, N. Y.

BOSTON NEW YORK PHILADELPHIA CHICAGO SAN FRANCISCO PITTSBURGH
BRIDGEBURG, CANADA LONDON, ENGLAND



The RāBAT

a Rechargeable
Wet 'B' Battery
at Only \$3.96

Here is a rechargeable wet "B" Radio battery built strictly on storage battery principles. Yet it costs only a trifle more than an ordinary dry cell battery.

The Rabat at the low price of \$3.96 has 12 cells with a total capacity of 24 volts. It is noiseless, fool-proof, and compactly constructed. Built on a solid rubber base. Small, but neat and efficient. All elements visible. No internal discharge. More economical. Longer life. Higher and more continuous voltage. Easily recharged at home with aid of inexpensive Rabat Rectifier. If your dealer cannot supply you send direct.

Rabat Rectifier for recharging\$.75

THE RADIO RABAT COMPANY

RUSSELL BUILDING Playhouse Square CLEVELAND, OHIO

12 CELLS **The RāBAT** 24 VOLTS

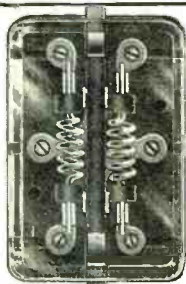

Make Your Aerial Safe!

It has all the dangerous possibilities of a lightning conductor—and it leads right into your house! Protect yourself from injury, your house from fire, and your instrument from damage by the use of a

H - C LIGHTNING ARRESTER

WITH GLASS COVER

\$1.25 Postpaid

HOLTZER-CABOT ELECTRIC CO.
6161 South State Street, Chicago, Ill.

WANTED—Back numbers of Radio News, Dec., 1921, Jan. and Feb., March and April-May, 1922. Experimenter Publishing Co., 53 Park Place, New York City.

contented; voting it a fitting end to the greatest of conventions.

Believe me, if there is another convention, I will surely be there. OM and OW we had some time and one we will never forget. Speaking of OW we had Mrs. 8CEP (Gee, but 8CEP is lucky), Enid Hamilton of 9CB, and Mrs. 1AFV. There were about five hundred at the banquet and a big bunch more that showed up at various times. Almost every night had a new crowd. At least a thousand must have been in Chicago before the end. I am surely glad to have met friends of the air.

Between two and three thousand dollars' worth of apparatus was donated for prizes by the manufacturers. FB OM.

Well, gang, nil nw so 73 es cul at the next convention.

AN ACKNOWLEDGMENT

The Second National Radio Relay League Convention wishes to thank the following manufacturers and distributors of apparatus, for their contributions and assistance in making the "Stunt Party" and other competitive events successful, by providing valuable, worthwhile prizes.

The Honor Roll:

- Acme Apparatus Co., Cambridge, Mass.
- Belden Manufacturing Co., Chicago.
- Bremer Tully Radio Co., Chicago.
- Burgess Battery Co., Madison, Wis.
- Carter Radio Battery Co., Chicago.
- Citizens' Radio Service Bureau, Chicago.
- Chicago Radio Apparatus Co., Chicago.
- Commonwealth-Edison Co., Chicago.
- Dubilier Radio and Condenser Corp., Chicago.
- Electric and Radio Supply Co., Chicago.
- French Battery and Carbon Co., Madison, Wis.
- Howard Radio Co., Chicago.
- Jewell Electrical Instrument Co., Chicago.
- Kellogg Switchboard and Supply Co., Chicago.
- Lynn Radio Co., Chicago.
- Manhattan Electrical Supply Co., Chicago.
- Wm. J. Murdock Co., Chicago.
- Radio Corporation of America, Chicago.
- Rauland Mfg. Co., Chicago.
- Stahl Rectifier Co., Chicago.
- Telephone Maintenance Co., Chicago.
- Thordarson Electric Manufacturing Co., Chicago.
- Trimm Radio Mfg. Co., Chicago.
- United Mfg. and Distributing Co., Chicago.
- Zenith Radio Corporation, Chicago.
- Grebe and Company, Richmond Hill, N. Y.
- Western Coil Co.

To the Chicago Committee for the Texas Hams:

Thanks for the best time we have ever had; thanks for a wonderful convention; thanks for the opportunity to meet our friends of the air; thanks for your friendliness and help; and may we meet again sometime not too long from now, and surely over the air. 73's.

Multiple Broadcasting

(Continued from page 680)

approximately 500 broadcasting stations of the United States. Until recently, all of its programs originated in New York City and were conducted along a wire from WEAJ, the broadcasting station of the American Telegraph and Telephone Company which broadcast the same program at the same time, but on a different wave-length. Thanks to special arrangements, the same

A Baldwin Receiver Will Make a Merry Christmas



YOUR Christmas radio set will give you the utmost in clear reception if it is equipped with Baldwin radio phones.

The Original Baldwin

—is superior to all other radio phones. It is manufactured under the personal supervision of the inventor, Nathaniel Baldwin. It stands in a class all by itself because of its construction features—light weight, supersensitive mica diaphragm, permanently responsive; circular magnet with two U-shaped pole pieces, giving four points of magnetic contact; built like a fine watch.



Look for this label on the box.

Ask your dealer for the ORIGINAL Baldwin. If he cannot supply you write for circulars and price lists.

NATHANIEL BALDWIN, Inc.

Salt Lake City, Utah

New York, 99 Chambers St.
San Francisco, Call Bldg.

Chicago, 1427 Michigan Avenue.
Kansas City, Chambers Bldg.

Here's Three New "Regal" Products This Season—Ask Your Dealer Why They Are Better

New "Regal" Double Arm Inductance Switch with Hard Rubber Knob and Dial

No. 162



A 17 point Inductance Switch complete in one unit. No more messy soldering—no more drilling of holes with chipped panels—no more switch points to assemble. Mounted on panel with one bushing. Ask for the genuine "REGAL."
Complete with Knob and Dial.....\$1.50

New "Regal" Audio Frequency Amplifying Transformer

No. 200



For clearness of tone, voice and music amplification, and freedom from howling and objectionable noises, the Regal is without a peer in the market.
3 1/2 to 1 Ratio.....\$4.50
5 to 1 Ratio.....5.00

New "Regal" Vernier Rheostat

No. 120

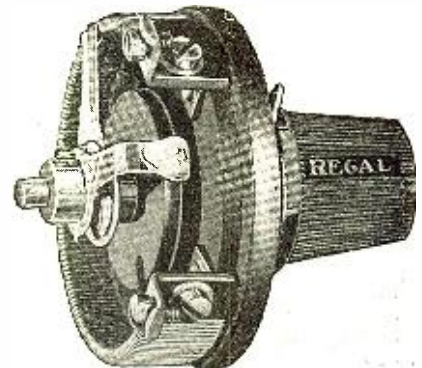

A Vernier Rheostat the trade has been waiting for. Smooth filament current control, enabling finest adjustment.

A superior Regal Product for exacting radio fans.
6 Ohms\$1.25
3C Ohms1.25

IF YOUR DEALER DOES NOT CARRY REGAL PRODUCTS WE WILL SHIP DIRECT. SEND US YOUR DEALERS' NAME AND ASK FOR OUR CATALOG NO. 18 SHOWING OUR COMPLETE LINE OF 30 REGAL ITEMS.

THE AMERICAN SPECIALTY COMPANY, Bridgeport, Conn.



**DESIGNED ESPECIALLY FOR
RADIO RECEIVING**

We are Manufacturers of Fine Furniture and we sell direct to you with only a small factory profit.

A handsome hardwood hand-rubbed mahogany or golden oak finished Radio Table. Size of top 20x34 inches x 31 inches high.

Conceals A and B batteries. Small drawer holds tools and accessories.

PRICE, FREIGHT PAID, East of Mississippi River \$18.00
 FREIGHT PAID to Rocky Mt. States 20.00
 FREIGHT PAID to Pacific States 22.50

Cash with order. We have prepared a large stock and can ship tables and cabinets immediately.

CABINET PRICES REDUCED!

Hardwood, hand-rubbed mahogany finish. Hinged top.

Panel Size	Depth	Price
6 x 7 in.	7 in.	\$2.25
6 x 10 1/2 in.	7 in.	2.50
6 x 14 in.	7 in.	3.00
6 x 21 in.	10 in.	3.75
7 x 18 in.	10 in.	3.50
9 x 14 in.	10 in.	3.50
12 x 14 in.	10 in.	4.00

POSTPAID, East of Mississippi River.

POSTPAID to Rocky Mt. states, add 25 cents.

POSTPAID to Pacific states, add 50 cents.

Cash with order.

Send for Free Catalogue of Radio Furniture

THE SOUTHERN TOY CO.
 HICKORY, NORTH CAROLINA

PATENTS

If you have an invention and desire to secure a patent, send for our Free Guide Book, **HOW TO GET YOUR PATENT.** Tells our Terms, Methods, etc. Send model or sketch and description for our opinion of its patentable nature.

RANDOLPH & CO.
 Dept. 459 Washington, D. C.

PATENTS
 C. L. PARKER
 Formerly Member
 Examining Corps,
 U. S. Patent Office.
 PATENT - LAWYER
 McGill Bldg., Wash., D. C.
Patents, Trade Marks, Copyrights, Patent Litigation
 Handbook for Inventors, "Protecting, Exploiting and Selling Inventions," sent upon request.

program may now be sent by three broadcasting stations simultaneously and it may originate at any place being relayed by wire to the various stations. Recently the radio audience was able to listen to music played in New York and sent through WEAF, WCAP and the private broadcasting station of Col. Green at Round Hill, Mass.

STATEMENT

Of the Ownership, Management, Circulation, Etc., Required by the Act of Congress of August 24, 1912, of Radio News, published monthly at Jamaica, L. I., N. Y., for October 1, 1923. State of New York (ss. County of Queens)

Before me, a notary public in and for the State and county aforesaid, personally appeared Hugo Gernsback, who, having been duly sworn according to law, deposes and says that he is the Editor of Radio News, and that the following is, to the best of his knowledge and belief, a true statement of the ownership, management (and if a daily paper, the circulation), etc., of the aforesaid publication for the date shown in the above caption, required by the Act of August 24, 1912, embodied in section 443, Postal Laws and Regulations, printed on the reverse of this form, to wit:

1. That the names and addresses of the publisher, editor, managing editor, and business managers are: Publisher, The Experimenter Publishing Co., Inc., 53 Park Place, New York, N. Y.; Editor, Hugo Gernsback, 53 Park Place, New York, N. Y.; Managing Editor, Robert E. Lacault, 53 Park Place, New York, N. Y.; Business Manager, R. W. DeMott, 53 Park Place, New York, N. Y.

2. That the owners are: (Give names and addresses of individual owners, or, if a corporation, give its name and the names and addresses of stockholders owning or holding 1 per cent or more of the total amount of stock.) The Experimenter Publishing Co., Inc., 53 Park Place, New York, N. Y.; Hugo Gernsback, 53 Park Place, New York, N. Y.; Sidney Gernsback, 53 Park Place, New York, N. Y.; R. W. DeMott, 53 Park Place, New York, N. Y.; H. W. Secor, 53 Park Place, New York, N. Y.; Dr. T. O'Conor Sloane, 53 Park Place, New York, N. Y.; Mrs. Catherine Major, 53 Park Place, New York, N. Y.; and M. M. Finucan, 720 Cass St., Chicago, Ill.

3. That the known bondholders, mortgagees, and other security holders owning or holding 1 per cent or more of total amount of bonds, mortgages, or other securities are: (If there are none, so state.) None.

4. That the two paragraphs next above, giving the names of the owners, stockholders, and security holders, if any, contain not only the list of stockholders and security holders as they appear upon the books of the company but also, in cases where the stockholder or security holder appears upon the books of the company as trustee or in any other fiduciary relation, the name of the person or corporation for whom such trustee is acting, is given; also that the said two paragraphs contain statements embracing affiant's full knowledge and belief as to the circumstances and conditions under which stockholders and security holders who do not appear upon the books of the company as trustees, hold stock and securities in a capacity other than that of a bona fide owner; and this affiant has no reason to believe that any other person, association, or corporation has any interest direct or indirect in the said stock, bonds, or other securities than as so stated by him.

5. That the average number of copies of each issue of this publication sold or distributed, through the mails or otherwise, to paid subscribers during the six months preceding the date shown above is (This information is required from daily publications only.)

H. GERNSBACK, Editor.

Sworn to and subscribed before me this 19th day of Sept., 1923.

(SEAL) JOSEPH H. KRAUS.

Notary Public, Queens County Register's No. 2951; New York County Register's No. 5291; New York County Clerk's No. 379. (My commission expires March 30, 1925.)

Book Review

I. C. S. RADIO OPERATOR'S HANDBOOK. 3 1/2" x 5 1/2", 564 pages, cloth cover, fully illustrated. Published by the International Text Book Company, Scranton, Pa.

This is one of the best examples of the numerous radio hand-books that we have seen. Although very compact, it probably comes as near to covering the entire radio field as is possible for a volume of its dimensions. The hand-book was compiled and published purposely for use by the professional operator, but would prove equally valuable to the amateur, broadcast listener and even the radio engineer. Included in the hand-book is a chapter on code practice which should be of interest to the broadcast listener who contemplates more serious things in the amateur field. Aside

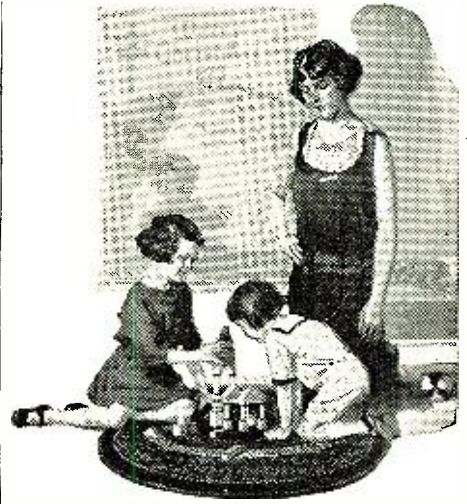

Protect the Children!

THE sturdy youngsters and tiny toddlers whose trusting fingers are twined about your very heart-strings play always under the threatening shadow of tuberculosis.

The dread disease is everywhere. Wealth is no bar and position no barrier to consumption. The only way to make the world safe for children is to stamp out tuberculosis entirely.

It can be stamped out. Today only one person dies of tuberculosis where two died before. Christmas Seals have helped to save the other life.

Help in this life-saving campaign. Save the children. Buy Christmas Seals.

Stamp out
 Tuberculosis
 with
 Christmas
 Seals



THE NATIONAL, STATE, AND LOCAL
 TUBERCULOSIS ASSOCIATIONS
 OF THE UNITED STATES

PATENTS. WRITE FOR List of Patent Buyers, Three Guide Books and RECORD OF INVENTION BLANK before disclosing inventions. Send model or sketch and description of your invention for Examination and Instructions. Electrical cases a specialty. Highest references, reasonable terms, prompt attention.

No charge for the above information

VICTOR J. EVANS & CO.
 919 NINTH ST. WASHINGTON, D. C.



**ROGERS
 RECEIVING
 RADIOMETERS**

may be used in any circuit that requires an efficient variable inductance for tuning. Write to the

\$3.00

ROGERS RADIO CO.,
 5133 Woodworth St., Pgh., Pa.

from the splendid chapters on transmitting and receiving stations, the reader will find a multitude of information on electricity in general, regulations, definitions of terms, tables and data of general engineering value. A list of broadcast stations is also included in the rear of the book.

This radio hand-book was compiled by Harry F. Dart, an Associate of the Institute of Radio Engineers, and American Institute of Electrical Engineers.

FUNDAMENTALS OF RADIO. By J. L. Thomas, 5" x 7½", 201 pages, cloth cover, fully illustrated. Published by D. Van Nostrand Company, 8 Warren street, New York City.

In writing this book, the author assumes that the reader has an elementary knowledge of electricity, thus skipping the tedious explanations of electrical terms, etc. The book commences with the elementary theory of radio followed by chapters on radio telegraphy and telephone transmitters and receivers, the two and three element vacuum tube, radio measurements, etc. The appendix contains a number of useful tables. This book is well adapted for use as a text book by instructors in radio schools, radio operators, amateurs, etc.

ELEMENTS OF RADIO COMMUNICATION. By E. W. Stone, 5"x7½", 318 pages, cloth cover, fully illustrated. Published by D. Van Nostrand Company, 8 Warren street, New York City.

Elements of Radio Communication is a splendid book for the amateur, as well as for the radio engineer. Although well adapted for reference work, it is a complete education in radio itself. The forepart of the book takes up the fundamental terms of radio, and where most books on radio fall short, well covers the theories of alternating currents at both low and high frequencies. Each piece of apparatus is explained separately so that it is clearly understood when referred to in later chapters covering complete commercial systems. Splendid material on wavemeters, decimeters, radio transmitters, antennae, etc., follows. There is also included a most interesting chapter on the propagation of radio waves.

A SYMBOL OF SAFETY. By Harry Brearley, 6"x9", 290 pages, fully illustrated. Published by Doubleday, Page & Co., Garden City, N. Y.

A Symbol of Safety is an interpretive study of the work carried on by the Underwriters' Labora-

"It Speaks for Itself"

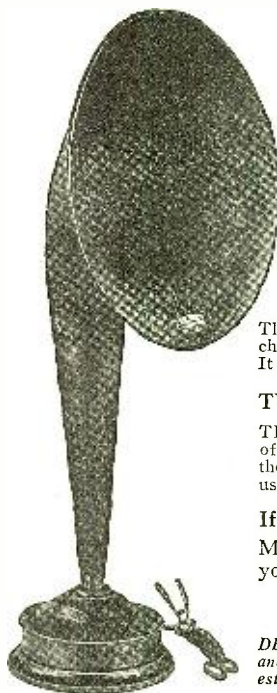

Little Senior (Complete with 6 feet of cord) **\$19.50**

TRUTONE LITTLE SENIOR is a complete Loud Speaker that is a marvel for its price. The large diaphragm contained in the perfectly cured wooden tone chamber in the base reproduces soft, true, clear and resonant tones. The beautiful crystalline composition horn makes the TRUTONE attractive to the eye and keeps its reproduction free from any metallic noises. The horn with 10 inch bell stands 24 inches high.

TRUTONE SENIOR (Complete with 6 feet of cord) **\$25.00**

The SENIOR is supreme for all long distance work as its extra large tone chamber with diaphragm built-in gives volume to the most distant sound. It stands 32 inches high with the bell of the horn measuring 14 inches.

TYPE "A" AND "B" AMPLIFYING HORNS.....\$8.00 each

TRUTONE AMPLIFYING HORNS are constructed for use with any make of head receivers. Reproducing the tones meant for ear contact so that the entire family may enjoy the receiving set. Type "A" is designed for use with double receivers and Type "B" for single receivers.

If You Can't Buy a TRUTONE From Your Local Dealer
Mail draft or Money Order direct to us and the model you desire will be sent to you postage prepaid.

All TRUTONES absolutely guaranteed.

DEALERS—The TRUTONE LINE means money and satisfied customers to you. Write our nearest representative today.

Atlantic Coast Representatives
Radio Stores Corporation
218-222 W. 34th Street
New York

Chicago Representative
The Direct Sales Company
431 S. Dearborn Street
Chicago, Ill.

SADLER MANUFACTURING CO.
86 FOURTH STREET SAN FRANCISCO, CAL.

SADLER MFG. CO.
86 Fourth Street, San Francisco, Calif.
Enclosed please find Money Order for \$.....
which send me.....
Postage paid.....
Name.....
Address.....
P.O. State.....

"B" Batteries that are built with a conscience

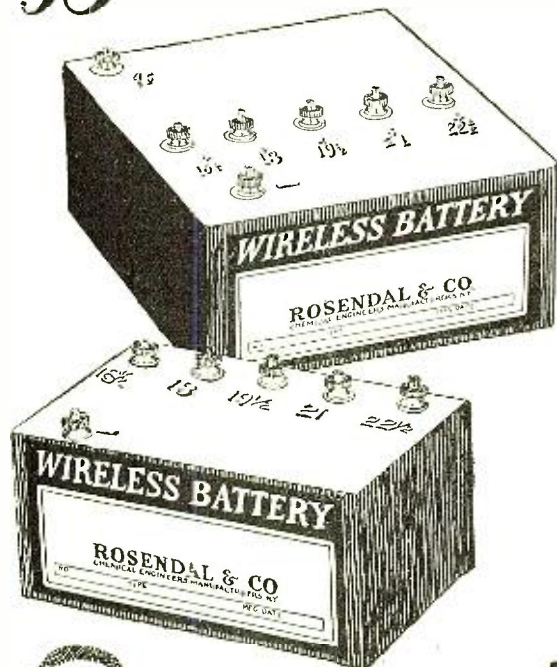

INTO every battery made by Rosendal is injected all of the years of experience gained thru analytical work for some of the largest Battery Manufacturers in the country—with the best of materials and most thorough care in its manufacture.

Rosendal is aware of the requirements of a "B" Battery and can therefore unequivocally guarantee the service you can expect from it. Either you are satisfied with its use or you may return it and your money will be refunded or a new battery sent in exchange.

Rosendal Production provides for fresh stock always. Orders shipped same day received.

Buy direct from the Manufacturer and save the difference.

		Large	Medium	Small
22½	Volt Plain	\$1.25	\$1.00	\$.70
22½	" Variable	1.38	1.13	.75
45	" Plain	2.50	1.75	...
45	" Variable	2.75	2.00	...

See that your "B" Batteries are always in good condition for best reception. A Jewel Volt Meter regularly sold for \$2.75 is yours for \$1.87 with every order for \$5.00 or over.

Send Money Order or order for C. O. D.

ROSENDAL & CO.

Chemical and Radio Engineers

2 and 4 Stone Street · New York



KC RADIO

KUALITY CERVICE

Kilbourne & Clark Mfg. Co.

Head Office and Works: Seattle

BRANCH OFFICES

PORTLAND 305 Larrabee St.	SAN FRANCISCO, 591 Mission St.
LOS ANGELES, 1103 W. 10th St.	NEW YORK CITY, 80 Washington St.

For 10 years we have built radio apparatus for ships, shore stations, U. S. Navy, amateur and experimental use.

OUR MERCHANDISING LINE

Receivers	Plugs
Amplifiers	Jacks
Head Phones	Adapters
Loud-Speakers	Sockets
Condensers	Amp. Transformers
Rheostats	Variometers
Potentiometers	Variocouplers
Switches	C. W. Apparatus

COMPLETE LINE OF MOULDED PARTS

WATCH THIS SPACE FOR THE LATEST SPECIALTIES



VARIABLE RADIO FREQUENCY AMPLIFYING TRANSFORMER
(Midget Size)

Two Stage, 2"x2"x5½"	\$10.00
Single Stage, 2"x2"x3"	5.50

Range 150—550 meters

CAN BE ACCURATELY TUNED TO ANY WAVE LENGTH BETWEEN THESE LIMITS
(NOTE SMALL DIMENSIONS)

FOR \$1.00 THIS IS WORTH LOOKING INTO

For distance, volume, clearness, selectivity, simplicity and ease of operation, it has no equal. Hundreds of others have tried it and all agree. Only two controls, no shielding, no freak coils or other doo-dads necessary. Entire set of standard stock material, can be built for \$17.50. The complete hook-up, simple description, list of all materials and where to get them. We sell no parts, only hook-up and how to build. This will save you at least \$50.00 on your set and you can't buy a better one for less than \$200.00. All questions answered for 10c stamps. **Any Complaint—Your \$1.00 Back.** My radio experiments, during the last 13 years have cost me, not less than \$10,000.00. The result is yours for \$1.00. Nothing accepted, but U. S. Money Order.

E. F. WAITS
Corinth, Miss.

RADIO PARTS

At wholesale prices.
Send for price list.

SYPPER MFG. CO., Dept. N. Toledo, Ohio

ories, that organization which extends its service of safety throughout the United States. Of particular interest to the readers of this magazine are the chapters covering the tests of electrical apparatus and insulation. This book should prove of value to manufacturers and individuals directly or indirectly connected to the numerous industries of the United States.

DIE DRAHTLOSE TELEGRAPHIE UND TELEPHONIE. By Dr. P. Lertes of the University of Frankfort, A.M. 200 pages. Paper cover. Fully illustrated.

This very admirable presentation of wireless telegraphy is the fourth volume of the series of natural science books published by Theodore Steinkopff of Dresden and Leipzig. This subject is presented in an interesting way. It is divided into sections, covering such topics as the Development of Radio from the earliest phases up to the present day, Wireless Telegraphy, Telephony, Practical Features, the Range of Utility, and Applications of the Science. The sections are divided into chapters, one to seven. The distribution of the subjects contained in this text book is admirably done. At the end of each chapter, very instructive lists are given in detail of books and of articles touching on the special subjects of the chapter. There are about 17 pages of this bibliography, as we may term it, scattered through the book, each of which refers to its own section; while we say bibliography, it is more than that on account of the important articles included. The illustrations are not numerous and are mostly diagrammatical. German fashion, this volume has one index of names and another of subjects.

RADIO — SCHNELL—TELEGRAPHIE By Eugene Nesper. 117 pages. Paper cover. Fully illustrated.

The name of the author of this book on radio high subject work is an adequate recommendation. It really is a wonderfully clear presentation of the subject and is devoted in a great part to actual apparatus, not merely to the dry theory. Numerous diagrams are included, but the tendency is to give reproductions of photographs or perspective diagrams making in all an admirable elucidation of their construction and use. All through it, familiar names are seen from Sofortige to Poulsen. The book has only 100 pages of text, but should not be neglected by anyone interested in this science. About 17 pages are devoted to a bibliography and articles on the subject are divided into sections and indexes of subjects.

GRUNDRISS DER FUNKEN-TELEGRAPHIE. By Franz Fuchs. 94 pages. Paper cover. Fully illustrated.

This compact little book is specifically a book its writer would say that, a beginners' book, for the beginner. To the readers of this review, if properly read, is the most attractive, there being nothing better for steadying our ideas than going over a good beginners' book. Unfortunately the good ones are rather few, as there is nothing harder than to write for a child or for a beginner. This book gives an admirable presentation of the subject. The text is about two-thirds the width of the page and the wide margin on one side is devoted to examples, calculations and very numerous illustrations, such as are needed to elucidate the subject. At the end is given the Continental-Morse Code.

An Efficient Amateur Station

(Continued from page 703)

to use enough antenna inductance in your transmitter to make the set oscillate easily and to emit a sharper C. W. on a legal wave-length.

The author will be glad to answer any

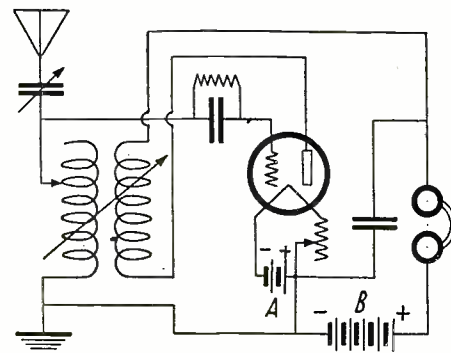

Circuit Diagram of Mr. Sullivan's Single Circuit Regenerative Receiver.

The choice of foremost Engineers for over 17 years.

Sold by all dealers



BRACH VACUUM RADIO PROTECTOR

Approved by the National Board of Fire Underwriters
Ask YOUR Insurance Agent

L. S. BRACH MFG. CO., Newark, New Jersey

SOLDERALL

Metal in Paste Form



Handy Tubes
Every Electrical Connection Needs Solderall for Perfect Reception.
The Only Convenient Metal Solder

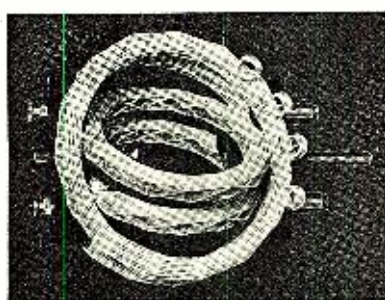

R. M. C. Diamond Weave Variocoupler and Variometer

Due to diamond weave construction and the fact that 7% of the total area of windings are supported in mid-air, capacity and dielectric losses are reduced to a minimum in R. M. C. Variometers and Variocouplers. The rotor is continuously variable. These products may be used in any circuit where a high grade coupler or variometer is required. All metal parts are nickel-plated. Panel mounting requires very small space. Screw holes covered by 2" dial.

R. M. C. products are built for the finest sets that can be constructed.

Variocoupler	\$4.25
Variometer	\$4.25

Write for catalog of other diamond weave coils and Radio Frequency Transformer.

THE RADIO MANUFACTURING CO.
of Springfield, Massachusetts
Dept. A 97 Dwight St.

RADIO SUPPLIES AT CUT PRICES

Federal or Brandes Headsets	\$4.95
Murdock Phones 2000 ohm No. 56	3.25
Acme Audio or Radio Transformers	3.95
Federal Audio Transformers No. 65	3.95
Audio Amplifying Transformers	3.25
Ames Audio Amplifying Transformers	2.95
22½ Volt Variable B Battery	.90
22½ Volt Variable B Battery	1.75
45 Volt Variable B Battery	2.50
22½ Volt Eveready B Battery	1.25
22½ Volt Eveready Variable B Battery	2.25
45 Volt Eveready Variable B Battery	3.95
43 Plate Var. Condensers Bakelite Ends	1.95
23 Plate Var. Condensers Bakelite Ends	1.50
3 Plate Vernier Condensers	.55
43 Plate Condensers with Vernier and Dial	3.95
23 Plate Condensers with Vernier and Dial	3.50

ALL ORDERS MUST INCLUDE POSTAGE

KENSINGTON RADIO SUPPLY CO.
4417 18th Avenue Brooklyn, N. Y.

questions on this receiver and transmitter and feels certain that if care and consideration are used, the builder will feel amply rewarded for his efforts by the results obtained.

Commercial Possibilities of Wired Radio for Central Stations

(Continued from page 699)

assured. Complete sets, especially adapted to receive wired radio can be sold to consumers. If the consumer does not wish to buy a set outright, the power company can rent him a set on a monthly basis. The power company could also handle the sale of extra equipment such as any necessary storage batteries, rectifiers and other charging devices, loud speakers, etc. With the establishment of a regular broadcasting service, a not inconsequential revenue can be obtained by selling time for advertising purposes. Should it prove undesirable to install a private studio for broadcasting purposes, the entertainment coming through the ether via space radio, can be re-broadcast over the power lines. In any event, provision can be made for so doing, in cases of emergency or temporary inoperation of the local service.

Then, too, arrangements might possibly be made with the nearest broadcasting station, whereby the programs sent out through the ether could also be broadcast over the power lines. In that case, the two parties concerned could come to an agreement about programs and operating expenses.

As a means for creating good will, the power company has a powerful tool in wired radio. The problems of maintaining service can be talked over direct with the consumer and the reasons and causes of any situation can be so presented that the consumer comes to feel that the power company has a personal interest in him. This building up of good will can sell a large number of shares of stock should the company decide to expand. Besides, it is but natural that the consumers be given first choice of any new security offered by the company.

To show how undeveloped the field of wired radio is, the following statement is of interest. It also shows the apparently limited interest taken by light and power companies in this venture. Of the 570 broadcasting stations licensed up to December, 1922, only four or a little over 0.7 per cent were operated by electric light and power companies.

Yet there is nothing in the transmitting end that presents any alarming difficulties. In most cases, the standard broadcast transmitters already available on the market may be utilized, with perhaps some slight changes, for broadcasting over the power lines. A government station license is not required nor is a licensed radio operator needed to take charge of the station. The non-radiating characteristics of the system permit this to be done. As to the receiving apparatus, only a set of the simplest type is required and is plugged directly into any socket or outlet in the room, and any number of these sets may be used in the same house. Should an apartment house full of tenants attempt to erect aeriols for their individual receivers, it can be easily seen what a chaos would result. There would be constant interference between individual receivers, due to re-radiation from the sets and the network of antennae would look rather messy.

Furthermore, the transmitting set for distributing the broadcasting need not have a power rating in excess of those used for space radio, and they can feed directly into a transmission line or into the intermediate-

WORKRITE NEUTRODYNE RADIO PARTS

(Licensed under Hazeltine Patent No. 1,450,080)

WorkRite Neutroformer

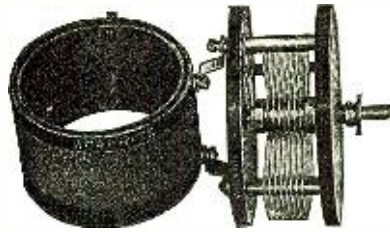

This instrument is made from two WorkRite Neutrodyne Radio Parts,—the WorkRite Variable Condenser and the WorkRite Neutrodyne Transformer mounted together. The Condenser is accurately made. Each part is held to within .001". The plates are properly spaced. End plates are made of hard rubber, highly polished. .0004 Mfd. capacity. The Transformer is most carefully made with just the proper spacing between the Bakelite Tubes and right number of turns of wire. The instruments are made to work together. They may be purchased separately if desired.

WorkRite Neutrodyne Transformers each, \$2.00. Set of three, \$6.00. WorkRite Variable Condenser, \$3.50. WorkRite Neutroformer, \$5.50.

WorkRite Neutrodon

Neutralizing a Neutrodyne Receiving Set requires careful adjusting. The best instrument for neutralizing the set will be none too good. The WorkRite Neutrodon will give the most accurate adjustment. Made for mounting on panel or in the line. Price each 50c. Set of two \$1.00.

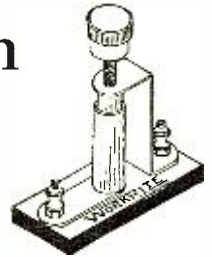

WorkRite Neutrodyne Kit

- 3 WorkRite Neutroformers
- 2 WorkRite Neutrodons

\$ 17⁵⁰

Panel layout and Book of Instructions.
The principal instruments of a Neutrodyne Receiving Set.

Use all WorkRite Neutrodyne Parts to get best results from your Neutrodyne Set. Send for free WorkRite Neutrodyne Hookup and complete catalog of WorkRite Radio Parts.

"WORKRITE RADIO PARTS WORKRITE"

The WorkRite Manufacturing Co.

1807 E. 30th Street

Cleveland, Ohio

(Branch Office, 536 Lake Shore Dr., Chicago.)



DUCK'S

FREE

Big 256 pp. Combined Radio Catalog and Text Book—No. 16. Mailed for 25c. in coin or money order. Not sent otherwise. Full of radio information and hook-ups. Prices extraordinarily attractive. Ever since 1909 Duck's catalogs have blazed the way with the best and most dependable radio products.

Send postal for our special price list on all radio instruments in our catalog and countless new instruments and sets not in Catalog No. 16. Of special importance to those having catalog No. 16.

THE WILLIAM B. DUCK CO.

711-12 ADAMS STREET

Dept. 3

TOLEDO, OHIO

RADIO BOOKS
Latest and Best. Catalog Free.
RAY DOBBINS
146 West 27th St. Indianapolis, Ind.

KILLOCH HEAD SET
2000 OHM \$3.25 POSTPAID IN U. S. A.
Baldwin Head Set \$8.75 Postpaid in U. S. A.
Send For Radio Catalogue
DAVID KILLOCH CO., 57 Murray St., N. Y. City

Morrison



\$10.00 Complete
Loud Speaker

Radio Satisfaction

True enjoyment of Radio begins when you and your family can sit comfortably in your living room and listen to all broadcasting reproduced in Clear, Full Volume. No annoying rattles, no harsh vibrations, no need for constant adjusting and fussing.

Morrison Loud Speaker gives you that kind of Radio satisfaction and pleasure, when attached to either your

Phonograph or Horn

Attach the Morrison Loud Speaker to the tone arm of your phonograph—takes only a moment—and you have the benefit of the excellent phonograph sound box. Or attach it to any horn.

A little dial on the back of the Morrison Loud Speaker adjusts the tone from soft, mellow notes, to full-volumed, clear notes.

There is nothing to get out of order. Any one can use this wonderful radio unit with the same perfect results as an expert.

Satisfaction guaranteed—or your money back.

Price complete with 5 foot cord

Nickel Plated Model.....	\$10.00
Gold Plated Model.....	\$15.00

Order from your dealer, or send direct to us if your dealer cannot supply you.

DEALERS

If you are interested in one of the fastest-selling Radio units on the market, write or wire for our proposition—it is interesting.

Write for Illustrated Catalog.

MORRISON LABORATORIES, Inc.
339 Jefferson Ave., East, Detroit Mich.

voltage distribution line from a sub-station To get the radio frequency energy on the transmission lines, a set of protective condensers and fuses are used. The condensers transfer the energy from any type of oscillator to the line by the capacity coupling thus provided. It is also possible to get more than one frequency on the power line at the same time, although for a larger number of frequencies, the equipment becomes more elaborate.

Both in Europe and in Japan, and also in this country, the system of wired radio for broadcasting purposes over high voltage transmission lines, is already in commercial use. Suitable receiving equipment has been developed and is in actual use in Staten Island, N. Y. This receiver is essentially designed for operation at but one wave-length, a single adjustment being provided to take care of slight variations in the transmitter frequency.

Elaborate tests have conclusively proven that the operation of high powered, high frequency generators into the distribution system does not open to damaging influences, either the system or the attached apparatus and equipment.

As a commercial project, there is no doubt that the idea is certainly feasible. Furthermore, it has proven a success as far as the experiments conducted can show. There is no reason for its monetary failure if the project is given the proper amount and kind of publicity and if a live selling campaign is started. If the public will buy receiving sets to get entertainment via space radio, they will surely buy receivers for wired radio. Space radio receivers have been more or less complicated and that limitation kept many from buying them. A wired radio receiver has but one control and is therefore the acme of simplicity. It is far less in initial and maintenance cost.

But aside from secondary consideration, it is to be believed that wired radio is of sufficient importance since it has already attracted the vital interest of several lighting companies in the United States. Into what the idea will be developed by these and other concerns remains for time to tell, and the actual results already obtained seem to indicate that the future is as bright for wired radio as it was for space radio a year or two ago.

WIRED WIRELESS IN GERMANY

Experimental work in wired-wireless is progressing in Germany. Consul Richardson advises the Department of Commerce. Recently communication was effected between Berlin and Stolp on the Baltic coast over a 400-kilometer line. This high-frequency telephone line has been turned over to the Federal Post authorities by the firm of Lorenz A.-G. Three calls at a time were put through successfully; one on the normal wave-length, another on a 45-kilometer wave, and a third on a wave of 25 kilometers. Instead of cathode tubes, a special high frequency generator was used.

Notes on the Autoplex Circuit

(Continued from page 711)

the most important considerations in the super-circuit are the grid-swing potential, the amplitude of the variation frequency and the amplitude or the strength of the incoming signal frequency. The latter can be controlled by some form of coupling system. The other two are more or less relative and vary considerably with circuit adjustments (so tend to undo any good that might be obtained from a coupling system). It stands as a fact, however, that with the Autoplex

RIGGS RECTIFIER

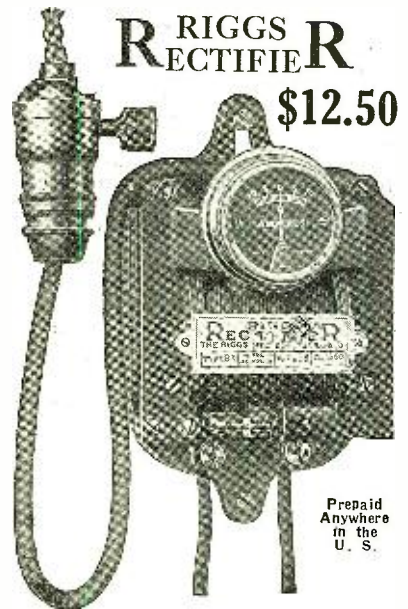

\$12.50

Prepaid Anywhere in the U. S.

Money Back Guarantee

We guarantee the Type B-3 to please you. If it does not, return it and we will return your money.

THE RIGGS MFG. CO.

Eastern factory Urbana, Ohio
Western factory Everett, Wash.

"COPPERWELD"
THE IDEAL RADIO ANTENNA

COPPERWELD IS 50% STRONGER than Copper, can be strung taut, stays up when other wires stretch and break, and gives 100% electrical efficiency

COPPER CLAD STEEL COMPANY
BRADDOCK P. O., RANKIN, PA.
Directions for Antenna construction on reverse side of carton

(Patent Pending)

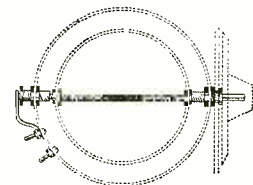

Now You can build your own variometers and variocouplers with the DANIEL Bearing and Mounting Assembly. Price

75c

New Ideas in Radio

The name "DANIEL" on radio appliances is your assurance of highest quality. Your dealer can supply you with these PROVEN specialties. Ask about the DANIEL Radio Lock Switch at \$1.00. If your dealer cannot supply you with any Daniel Appliance it will be sent post-paid upon receipt of price and dealer's name.

R. W. DANIEL,

Manufacturer and Distributor

5232-38 MELROSE AVE., LOS ANGELES, CALIF.



RADIO "B" BATTERY

DIRECT FROM FACTORY TO YOU
Greatest radio B battery on market. Absolutely fresh, full voltage, seamless cells, noiseless—will bring in Concerts **LOUDER** and **STRONGER!** Built correctly—full number of voltage taps—will work any tube or loud speaker. Real service **GUARANTEED.** Sold direct from our factories to you at lowest prices. Shipped prepaid to your door. **ORDER TODAY.** Send money order, check or pay C. O. D. Order By Number

No. 422B—22½ volt variable—regularly \$2.25—our price \$1.98
No. 422A—22½ volt variable—regularly \$3.00—our price \$2.65
No. 445A—45 volt—8 taps—regularly \$5.00—our price \$4.98

AYRES BATTERY CORPORATION. Cincinnati, Ohio

circuit the best means of signal strength control, is by varying the size of the collective agency. When local stations are weak as to volume, decrease the size of the collective agency. Even a ground connection may be unsatisfactory as it stands. In some cases, a length of lamp cord may be found the most efficient type of aerial to use with the set. This all requires experimenting on the part of the operator, but is the only way to determine the type, and exact size of the collective agency for the particular location.

USING AUDIO FREQUENCY AMPLIFICATION

If considerable volume is desirable, one stage of audio frequency amplification can be used without noticeably changing the operation characteristics of the receiver often experienced in connection with regenerative circuits. The connections for such an arrangement are shown in Fig. 3. It may be found, in some cases, that the impedance of the primary of the amplifying transformer is not sufficient to match that of the tube, therefore added impedance will be a requirement. For further information on this, the reader is referred to the article by Prof. W. A. Powers in the June issue of RADIO NEWS, entitled "Matching Impedances," which is quite comprehensive and should give one more insight into this seldom mentioned subject. Added impedance, it is understood, can be connected in series with the primary of the amplifying transformer. The value can only be determined by cut and try experiment or by actual measurement of the plate filament impedance of the vacuum tube and the impedance of the primary winding of the amplifying transformer. It should be remembered, also, that the primary leads of the audio frequency transformer should be reversed to determine the most favorable connection.

The addition of audio frequency amplification has another advantage. Most audio frequency transformers are very inefficient in amplifying high frequencies. Therefore the little of what there is of the variation frequency produced by the first tube, finds a high impedance path in the amplifying transformer and is, therefore, amplified only to a small extent or, in some cases practically obliterated. Signal and speech frequencies, however, are amplified in the usual manner, and what part of the variation frequency might make its presence in the loud speaker, would be so weak as to make it unnoticeable when compared to the strength of the signal or speech frequency.

Crystal Wins

(Continued from page 689)

UV-201A tubes are used for amplifiers, these having very fine amplifying characteristics when functioning either as radio frequency or audio frequency amplifiers. 201A's give a greater electron discharge from the filament than the dry cell tubes. No trouble is experienced with the tubes ringing when jarred as with the dry cell tubes. The Western Electric Co.'s 216A's may also be used to advantage. The old type UV-201 is not recommended. It is advisable to use sockets having a grip contact rather than those having spring pressure contacts.

Any two-circuit tuning device may be used. In the circuit described, a Chambers 2,000-meter coupler was used as a tuner, also a capacitive couple tuner of the Cohen type. Trial will determine which is the better side of the secondary to connect to the grid. The .0025 mfd. condenser permits the passage of radio frequency currents in the secondary lead to the center of the potentio-

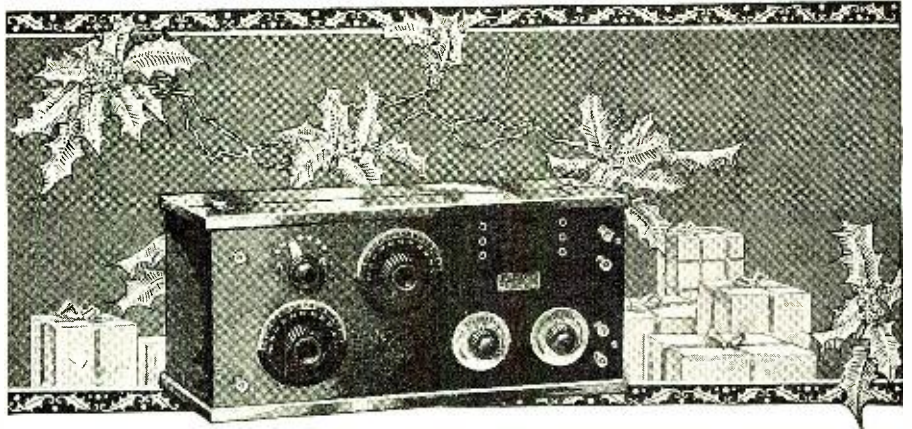

The Improved
MIRACO *The Ideal Gift*
from the Family
to the Family.

Model K
(Shown Above)
\$29.50

It is a two-tube outfit consisting of one stage of tuned impedance radio-frequency amplification with a tuner and vacuum tube detector.

This radio-frequency receiver amplifies before it detects, eliminates interference to a marked degree and has much more volume than most one-tube sets.

We also make a one-tube outfit, that gets 'em from Coast to Coast, for
\$18.50

Model MW
(Shown Below)
\$54.50

The Model MW consists of the same high-grade units as our Model K, with the addition of a two-step audio-frequency amplifier in a single beautifully finished solid mahogany cabinet. It is a four-tube set, comprising one stage of tuned impedance radio-frequency amplification, detector and two stages of audio-frequency.

Make this Christmas the happiest you have ever had. Instead of the usual exchange of small remembrances, let Daddy, Mother and the Kiddies all put the money that they would have spent for individual gifts into a common fund—a family fund with which to buy a Miraco Radio Receiving Set—the ideal gift from the family to the family.

Then, after every one else has forgotten Christmas, your little group will have evening after evening of wonderful entertainment—a constant reminder of that Miraco Christmas!

In quality, Miraco is of the finest; in price, of the lowest. Features such as sockets resting on shock absorbing pads, improved rheostats with multiple resistance windings, new aluminum shield preventing annoying body contact, solid mahogany cabinet and the finished workmanship thruout are refinements found only in the most expensive sets.

And then you need not be content with local stations only, for users tell us that Miraco gets 'em from Coast to Coast. New York hears Cuba, Chicago hears Porto Rico, Cincinnati hears Frisco, etc.

Start saving NOW for a Miraco family Christmas! It's an ideal way to get an ideal gift.

Write for our new bulletin
TODAY

DEALERS — JOBBERS
Write for proposition quickly.

AGENTS
There's still some territory
open—write or wire.

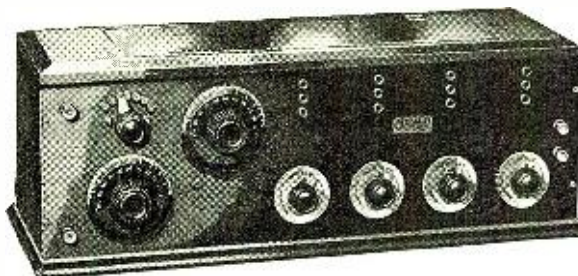

THE MIDWEST RADIO CO. 804 MAIN STREET
CINCINNATI, OHIO

SHINN
AMPLITONE
ANTENNA

BETTER RADIO RESULTS
by using the
AMPLITONE Flat Radio Antenna

Greatly increases the efficiency of your Receiving Set. Braided in flat form, composed of ten pure copper wires affording great receptive capacity essential in receiving signals clearly. Has greater tensile strength than the requirements of Underwriters.
Increases Range and Reduces Rasping by increasing strength

of signals. Makes the Little Set Work Well and the Big Set Work Better. A single 75 foot length of Amplitone gives better results than a number of single wires—spreaders no longer necessary. Can be furnished in any desired length. An appropriate Xmas Gift. Amplitone Antenna, 75-ft. length, with two antenna clamps, boxed, shipped prepaid for \$3.00.

W. C. SHINN MFG. COMPANY

14 E. Jackson Blvd., Chicago, Ill.

SCHINDLER'S BUILD-UP



50c to 75c

Mica Condenser

Schindler's "Build-Up" Condensers fill a definite need for reasonably priced condensers that may be easily increased or decreased in capacity. By the use of a "Build-Up" Mica Condenser you can change from an ordinary phone condenser to a special .006 value used in the Flewelling Circuit. By simply adding extra plates of mica and copper to the "Build-Up" base, you can obtain any definite capacity from .00025 to .006. (Each mica plate with the alternate copper plate has a capacity of about .002 Mfd.)

"Build-Up" Condensers are dilation proof. They insure high efficiency and will add satisfaction to the operation of any set. Each assembled complete in neat carton.

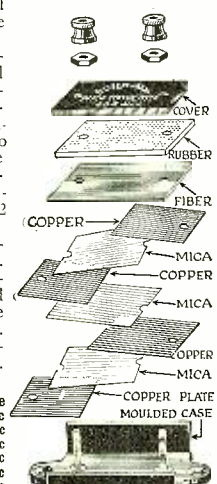

Mfd.	List price
.00025	50c
.0005	50c
.001	55c
.002	60c
.0025	65c
.005	70c
.006	75c

Extra envelope containing 20 mica and 20 copper plates, or sufficient to build up a condenser from .00025 to .006, list price 25c. Table showing required number of plates for any capacity is furnished with each Condenser. Ask your dealer or order direct.

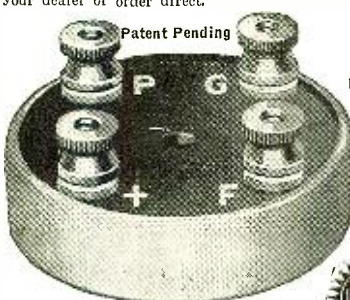

Patent Pending

\$2 including Hook-up Charts

SCHINDLER'S RADIO FREQUENCY TRANSFORMER

Makes signals audible on a small indoor loop aerial that were originally too weak for detection even on the outdoor type of antenna. "Excellent results obtained," says Radio News Laboratories. Made in two types. Type A for wave length of 150 to 500 meters. Type B for 300 to 650 meters. Price \$2 either type. If your dealer can't supply you order direct.

CHARLES SCHINDLER
Manufacturer of Radio Parts and Specialties
1401 West Delaware Avenue, Toledo, Ohio

Send for DEALERS Catalog

HARRY ALTER'S "POCKETBOOK" is a monthly net price catalog of Radio, Electrical and Lighting supplies. All good dealers should have a copy—get on our mailing list now. No obligation. Use your letterhead.



HARRY ALTER & CO.

WE SELL WHOLESALE ONLY
1000N BOUL. & CARROLL AV. CHICAGO

Important Notice Next Month

RASLA SALES CORPORATION
10 East 43rd Street New York City

meter and effectively prevents any audio frequency currents from passing other than through the secondary of the last audio frequency transformer.

No stabilizing potentiometer is necessary for the first tube when it functions as a radio frequency amplifier. The necessity for this stabilizing potentiometer, which is usually used, is eliminated by the fixed negative bias on the grid.

The "Music Master" loud speaker was used, as will be seen from the illustration. Any loud speaker not using a separately excited magnetic field will be satisfactory.

The writer favors the cabinet mounting rather than the panel mounting, believing the cabinet to be more artistic and at the same time permitting an efficient arrangement of the various instruments. The inside dimensions of the cabinet used are 14"x10"x5". The two potentiometers and a line rheostat are located on the front panel; this permits easy adjustment. The rheostats for each tube are rarely adjusted after the initial setting; they can be conveniently mounted on the lid of the cabinet.

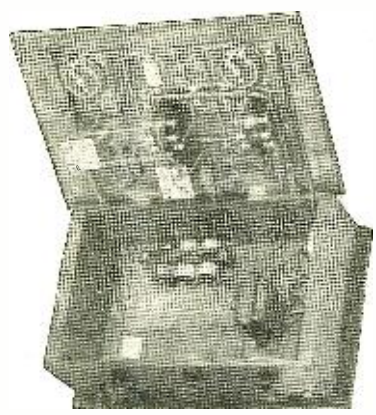

Interior View of the Reflex Receiver Showing the Position of the Amplifying Transformers.

After the respective instruments are mounted and wired, the procedure for initial adjustment is as follows: Adjust the rheostats until the tubes receive their rated filament heating current, then short the aerial and ground and with the secondary of the tuner connected adjust the potentiometers until the A.C. hum in the loud speaker is a minimum. When this adjustment of the potentiometers is properly made, the hum in the loud speaker will be hardly audible. Then, using the aerial and ground, adjust the primary and secondary of the tuner to resonance wave-length and make several adjustments of the crystal detector during the reception of the signal. These adjustments correctly made need be altered only if the line voltage changes. The primary and the secondary must always be tuned to resonance, otherwise the first tube will howl. No other alterations of the adjustments of the circuit are necessary.

The incoming signals are transferred from the primary to the secondary of the tuner; then to the grid of the first tube, where they are amplified at radio frequencies and passed on to the second tube. Here further radio frequency amplification occurs and the intensified radio frequency current is rectified by the most efficient rectifier, "the crystal detector." The current now at audio frequency is passed through the first audio transformer and into the second tube, where audio frequency amplification occurs. Further audio amplification occurs through the second transformer and first tube, the current having now reached sufficient value to properly operate a loud speaker. Unlike some receivers there are no critical adjustments to make for long distance reception.

KLAUS

RADIO SERVICE

Makes Money for Dealers



Get Free Bulletin

Klaus Radio Dealers receive expert service in radio problems and in radio merchandising. Our dealers *make more money*. We want a dealer in every city and town. Some territory is still open. Write for our trade discount lists and the "Klaus Radio Bulletin."

KLAUS RADIO & ELECTRIC CO.
Authorized Distributors
Dept. 200 EUREKA, ILL.

DURATEK



The Permanent DETECTOR

(Patent Pending)

FOR THAT REFLEX!

Requires no adjustment and works surely, clearly and permanently, in any radio circuit where a Sensitive Crystal Detector is most essential. Ideal for use in connection with REFLEX circuits and other type of amplification. Absolutely guaranteed against imperfection or faulty operation.

FOR PANEL MOUNTING \$1.25
MOUNTED \$2.00

At your dealer or direct from us.

The Erisman Laboratories
Washington Hgts. Bldg. Dept. R, 168 St. & Mitchell Sq.
NEW YORK

Q. T. RADIO PRODUCTS



TYPE 79 RECEIVER
Mahogany stained oak cabinet, engraved Radion shielded panel, 30-ohm rheostat, 23-plate Bakelite condenser, 180° Bakelite green silk variocoupler. Inside rear binding posts, bus-bar wiring, nicked brass parts.

List Price, \$17.00

Complete with Brandes phones, "A" and "B" batteries and W.D.12 tube, \$27.50

TYPE 718 DETECTOR AMPLIFIER
Solid mahogany cabinet, Radion shielded panel, two stages, inter-stage jacks, wired for "C" battery. All-American Transformers.

List Price \$45.00

Complete with Atlas Amplitone Loud Speaker, Three W.D.12 Tubes, A, B, and C, Batteries.....\$87.50

If your dealer can not furnish these sets order direct from manufacturer.

THE Q. T. LIGHT CO.
East Orange Dept. C-3 N. J.

Brandes

All Brandes products are sold under a money-back guarantee.

New - the Table-Talker!

New! New in the quality of its performance. New in the beauty of its appearance. New in the moderation of its price.

Another Brandes achievement—worthy to stand beside the now famous *Matched Tone Headset*. Brandes engineers have worked more than two years to make its tone strong, mellow, true.

Attractive—because an expert decorator suggested its simple lines and neutral brown finish.

The perfect gift for every radio fan. The easiest way to transform a one-man set into a joy for all the family!

C. BRANDES, Inc., New York

\$10

Table-Talker

TRADE MARK REG. U.S. PAT. OFF.



tions. The efficiency and flexibility of this radio control system were proven during the recent tests passed by the aeroplane before the Reception Committee of the Aeronautical Technical Service of the French Government on June 28, of this year. Five tests had to be passed, consisting of flights of 15 minutes at various altitudes, several turns to the right and left, landings and flights at 1,500' and 3,000'. In the last test the aircraft had to effect a spiral landing of 1,000' in diameter from an altitude of 3,000', which it accomplished perfectly. These tests present considerable interest, for they show that the automatic radio controlled aeroplane is practical and may be developed to such a degree of perfection that it will be possible in the very near future to use it for commercial purposes by sending it up, directing it toward a certain city and taking it down by means of another radio station, installed on the landing field, which would take over the control of the plane upon its arrival within the radius of the controlling station, the plane flying by itself between the two aerodromes.

Construction of Super-Heterodyne Receivers

(Continued from page 691)

frequency amplifier consists of four stages with transformer coupling and detector, the tuned circuits being connected as shown in Fig. 4, between the last amplifying tube and the detector. The audio frequency amplifier does not present any departure, it is composed of three stages with the necessary jacks, rheostats and "C" batteries. It is only necessary to operate the loud speaker, because when head phones are used, they are generally plugged directly in the detector circuit.

When using an outside aerial with the honeycomb coil tuner, a regenerative action may be obtained by means of the feedback coil connected in the plate circuit of the frequency changer; but in this case the strength of the local oscillations must be reduced by either filament control of the oscillating tube, or by variation of the coupling between the pick-up coil and the heterodyne. The constants for the oscillator circuit are the same as those given previously.

With this receiver using an indoor aerial or the light line through a condenser plug, very distant stations were heard in spite of the heavy interference around New York City. The selectivity is such that by moving only the vernier control of the oscillator condenser, powerful broadcasting stations only a few blocks away are entirely eliminated. Stations in the Middle West are regularly heard; when good weather prevails, and with an outdoor aerial, stations on the Pacific Coast are heard on the loud speaker.

Radio Vision

(Continued from page 681)

matically recomposed on a screen. There is very little complication here.

The day will come when you will be able to sit at home and witness a baseball game as it is being played five thousand miles away or you will be able to sit at home and not only listen to, but also actually see an opera as it is being sung and acted. In



The FANSTEEL Balkite battery charger

PATENTS APPLIED FOR

has no vibrators, bulbs or moving parts and is entirely noiseless

FANSTEEL BALKITE

is a new metal developed for this charger. It acts as a valve, allowing current to flow into the battery but not out of it. It is the most efficient charger valve made, is practically indestructible, and does a way with noisy, delicate vibrators and fragile bulbs.

The Gould Storage Battery Company is also marketing, under the Fansteel Balkite Patents, a complete battery and recharging unit known as the Gould Unipower, into which this charger, under the name, "The Fansteel Balkite Rectifier," has been incorporated.

The Fansteel Balkite Battery Charger for Radio "A" Batteries [6 volt] is an entirely new type of rectifier, based on the use of Fansteel Balkite, a new and rare metal developed for this purpose. It is entirely noiseless. It cannot deteriorate through use or disuse. It has nothing to replace, adjust, or get out of order. It cannot discharge or short circuit the battery, and requires no attention other than an occasional filling with distilled water. It will not overcharge, and cannot fail to operate when connected to the battery and line current. It is unaffected by temperature or fluctuations in line current. It is simple, efficient, and indestructible except through abuse.

The Fansteel Balkite Battery Charger will charge the ordinary 6 volt radio "A" or automobile storage battery at 3 amperes, from 110-120 AC, 60 cycle current. It comes complete and ready for use. Get it from your dealer, or use the coupon below.

Price, \$18
(\$18.50 West of the Rockies)

FANSTEEL PRODUCTS CO., Inc.

Dept. 7-A North Chicago, Illinois

Dealers and Jobbers: The Fansteel Balkite Battery Charger does away with complaints and replacement troubles. Write for literature and discounts.

Dept. 7-A

FANSTEEL PRODUCTS Co., Inc., No. Chicago, Ill.

Enclosed please find \$18. (\$18.50 west of the Rockies.) Send me the Fansteel Balkite Battery Charger for Radio 6 volt "A" Batteries. If I am not entirely satisfied I will return it and you will refund my money.

Name
Street
City State

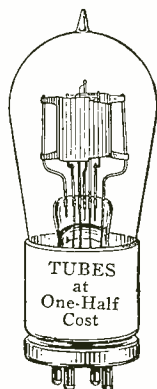

IT HAS HAPPENED TO ALL OF YOU IN A FRACTION OF A SECOND!

WHEN the filament burns out, at least \$5.00 goes with it to put the set in operation again.

WHY not save nearly one-half the cost of a new tube by sending us your burned out or broken tube to be repaired?

WE REPAIR EVERY TYPE of tungsten wire filament receiving tube. All our tubes are TESTED and GUARANTEED to function as well as when new.

All tubes returned P.P., C.O.D.

HARVARD RADIO LABORATORIES

BOSTON P. O. BOX 1781 MASS.

Insure your copy reaching you each month. Subscribe to Radio News —\$2.50 a year. Experimenter Publishing Co., 53 Park Place, N. Y. C.

THE IDEAL GIFT



\$15.00

F. O. B. Cleveland.
Type 6 Charges 6 Volt Storage Battery from any 110 Volt 60 Cycle lamp socket at average rate of 6 Amperes, or over if battery needs it.

The Satisfactory Charger for Ten Years Past

The F-F, the first successful mechanical charger, is now the most popular. F-F features are distinctive, its construction is simple, and the absence of breakable parts which are expensive to replace, is almost sufficient reason for you to own the

F-F BATTERY CHARGER

Fool-Proof and Shock-Proof

But the satisfaction you will buy with its low purchase price is further reason why you should insist on the F-F.

Buy from your dealer. There's a type for every need. If he cannot supply you, write for literature or enclose remittance covering express or postal charges on 9 lbs.

Write Immediately
for Free Charger Bulletin

The France Mfg. Co.

10432 Berea Road
Cleveland, Ohio

*Pioneer Manufacturers of
Patented Battery Chargers*

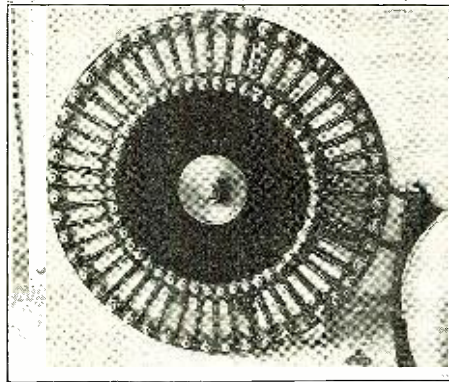

Front View of the Receiver Disc Showing How the Lens Prisms are Mounted.

other words, not only the music, but the action will be broadcast simultaneously. In future wars, it will be possible for an Admiral to witness a naval battle and follow it with his own eyes, although his battleship squadron may be thousands of miles away.

Simplifying the Radio Receiving Set

(Continued from page 692)

met the needs of this class of buyer. Before conversion, the front panel of the set appeared as is shown in Fig. 1.

Now one will have to admit that as efficient types of sets go this is about as simple a panel as one could find anywhere. After the conversion it appeared as shown in Fig. 2.

Everyone will agree that this conversion is highly desirable, but some may at the same time be skeptical about the successful operation of the set by a novice as converted. Fortunately, however, there need be no such skepticism for the writer has proved the operation of the set by actual test.

The parts of which this set is composed are antenna, 23-plate variable condenser, variocoupler, detector, 10 to 1 audio transformer, first stage amplifier, 3 to 1 audio transformer, second stage amplifier, jack, grid leak and grid condenser.

The relative positions of these parts can be easily deduced from the positions which the respective controls occupy on the panel shown in Fig. 1. However, to make the method of conversion absolutely clear, a circuit diagram of the set is shown in Fig. 3.

Particular note should be made of the fact that the circuit is one which is standard and which is entirely devoid of freak connections. Also note that in the list of parts described above was included an antenna. It is beyond the limits of apparatus designed up to this date to standardize a particular set, that is, to make its operation uniform with all users and under all conditions without including the antenna as an integral part of the set, for two different antennae will make the sets on which they are separately connected tune in an entirely different manner.

The tuning in process on this set before conversion was about as follows: The aerial tuning inductance double point contact switch was permanently placed on switch points 3 and 5 reading from the right. The variable inductance dial or rotor member of the variocoupler was permanently placed at 95. Note here that these two adjustments are both permanent and might just as well have been done before the instrument reached the user as afterwards.

Next, the short wave condenser is rotated to the point of resonance. Previous to these three adjustments, of course, the three filaments of the vacuum tubes had been simultaneously put in operation by means of an

LOOK HERE



FREE! I GUARANTEE to make you an EXPERT DRAFTSMAN, right in your own home, in your spare time! I guarantee to prepare you to hold down any job at top pay. I guarantee your money back if you are not satisfied. And I guarantee to train you until you are actually placed in a position paying at least

\$250 a Month!

You cannot find pleasanter, easier work than Drafting. Common schooling all you need. Thousands of big pay jobs at \$60 to \$100 a week open right now! Get ready—start immediately!

Expert Draftsmen Wanted!

Before any machine, product or building can be made a Draftsman must draw the plans. This is the business to get into. Write today for my 2 Free books find out how big this opportunity is!

2 Catalogs Free—Write Today!

Chief Draftsman
Coyne School of Drafting
Dept. 923 1-9 S. Ashland Ave. Chicago, Ill.

START NOW!

Radio Bargains

for THIS MONTH

- Hedgehog Transformer \$3.15
- Reflex Crystal89
- Battery Test Clips (each)..... .05
- 199 Tube Adapter49
- Licensed Neutrodyne Parts...19.98
- Rheostats, 6, 25, 40 ohm..... .69
- Variocoupler or Variometer
(180 degree) each 1.28
- Erla Reflex Transformer..... 4.65
- Murdock 2000 Ohm Phones... 3.65
- Jewell Lightning Arrester..... .98
- Cico Two-way Plug..... .49
- Cockaday coil, each..... 1.89
- Contact Points or Switch
Stops, per dozen10
- Special Prices on Tubes,
Magnet Wire, etc.

Clip this List—Check Items You Want Enclose With Money Order Your order will be filled by return mail postage free. Satisfaction or Money Back.

FANS List of bargains FREE

RADIO BARGAINS
17 N. LA SALLE ST-CHICAGO

SUPERIOR

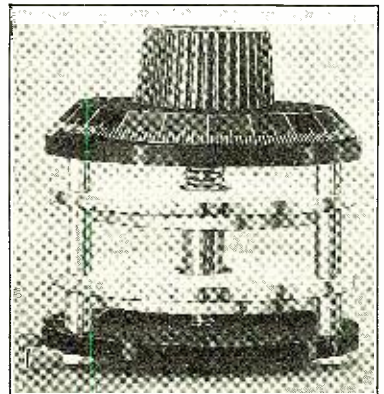

All Vernier Condenser, capacity from 3 to 43 plates; varies uniformly; gives very sharp tuning; short circuiting impossible.

List Price \$3.00

SUPERIOR INSTRUMENT CO.
118 WALKER STREET, N. Y.

Phone: Franklin 2039

AT ALL DEALERS OR DIRECT BY MAIL

Tapped Amplifying Transformers

for those who demand more than has heretofore been secured from audio frequency amplification. Supplied in sets of two.

MODERN 10 to 1
has carved its own way to fame by performance in reflex circuits. Also preferred by many on the first stage of standard audio frequency amplifiers.

MODERN 4 to 1
meets with a welcome wherever it goes. The many repeat orders attest to its all around efficiency. Write today for illustrated circulars and bulletins.

THE MODERN ELECTRIC MFG. CO.
Dept. 512 Toledo, Ohio

For Best Reception You Need

THE GOODMAN

niftiest short-wave tuner on the market. Great for present broadcast, local and DX. Used in all parts of the world.

Certificate of Merit from Radio News and others.
Send for pamphlet.

L. W. GOODMAN, MFR. Drexel Hill, Pa.

"A" battery switch. The tubes used were of the modern high resistance type which consume a very small amount of current.

The respective positions of the three rheostats were: Detector, barely "on"; first amplifier, one-half "on"; second amplifier, full "on." Using the new detector tubes in combination with the old low resistance rheostats makes regulation of the volume by means of the detector not only undesirable but altogether impossible, for one may turn the detector rheostat on to its limit with perfect safety but without effecting the operation in the slightest degree. In other words, these tubes are not at all critical in the operation as described. The writer does not mean to imply that every set will operate in a like manner, but merely wishes to state a set of facts which are peculiar to the operation of this type of apparatus under the conditions described.

It is not a very difficult matter for the reader to figure out how the conversion was made. First of all, the numbered condenser dial was removed from the front of the panel and the type here illustrated (an invention of the writer's), screwed on to the shaft in its place. Broadcasting stations, which a test had determined as reliably within the range of the set, were inserted in their proper places on the condenser. These were stations KYW, WJAZ, WPAD, WOC, WGY, KSD, WWJ, WLAG, WDAP, WGN and WMAQ. Note that these stations are all within the thousand-mile range. They represent the 11 stations which happened to tune in easiest and loudest on this particular set under the given conditions. Experiment over a period of 30 days in the month of July proved that the regular tuning in of these stations could be accomplished with absolute reliability from any area within a 40-mile radius of Chicago with exactly the same adjustments.

While on occasion the set tuned in as many as 22 stations in a single evening, some of them being as far distant as the Pacific Coast, no attempt was made in converting the receiver for novice operation to enlarge the range of the set beyond that considered reliable. In fact, under very adverse weather conditions, it is questionable if the 11 stations chosen could be termed entirely reliable.

The next operation was to take the detector and first amplifier rheostats off the front of the panel and adjust them to permanent positions on the back of same, leaving only the second amplifier rheostat on the front of the panel and marking this simply "Soft-Loud." Finally the "A" battery switch was placed in the center of the panel and marked plainly, "On-Off." Full directions for the operation of the set were permanently affixed to the front of the panel as follows:

DIRECTIONS—To operate this set, first turn the dial at your left to the station desired. Now turn the switch in the center of the panel to the "ON" position. To increase the volume of the station heard, turn

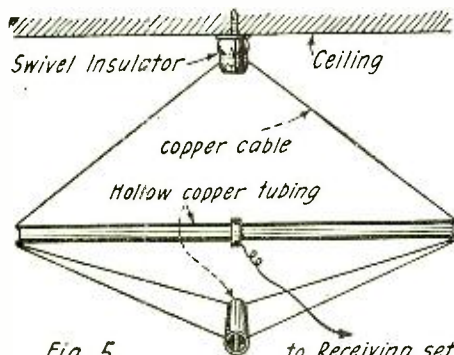

Fig. 5
A Novel Type of Indoor Aerial with Which the Author Obtained Good Results.

New
Pathé
REG. U.S. PAT. OFF.
LOUD SPEAKER



Price
\$22.00

"It speaks for itself"

Science has now produced the perfect loud speaker. It is based on an entirely new principle. It is the crowning triumph of the world famed Pathé acoustical engineering laboratories.

Now the finest variations of voice and instrument are reproduced without distortion. Now the broadcasting of distant stations is brought nearer.

Mr. Ross Harter of Frankfort, New

York, experimented for months with many makes of loud speakers in an effort to hear Los Angeles broadcasting. His experiments failed until he tried the Pathé Loud Speaker. Now he hears over 2400 miles clearly, distinctly and without distortion.

Your dealer has the Pathé Loud Speakers. Call upon him and listen to your favorite station.

PATHE PHONOGRAPH AND RADIO CORP.
20 GRAND AVENUE, BROOKLYN, N. Y.
533 South Wabash Ave., Chicago, Ill.

Como Duplex Transformers

The COMO DUPLEX SYSTEM of audio-frequency amplification gives the maximum volume without distortion and tube noise.



COMO APPARATUS COMPANY
446 TREMONT ST., BOSTON, MASS.

There is a combined filtering action which assures perfect results when ordinary amplification fails.

It can be added to your present amplifier, giving you power amplification on the weak signals that more of the ordinary amplification would kill.

Sold in matched pairs for only
\$12.50

A copy of C. White's "HOW TO MAKE A POWER AMPLIFIER" is yours for the asking.

WANTED—Back numbers of Radio News, Dec., 1921, Jan. and Feb., March and April-May, 1922. Experimenter Publishing Co., 53 Park Place, New York City.

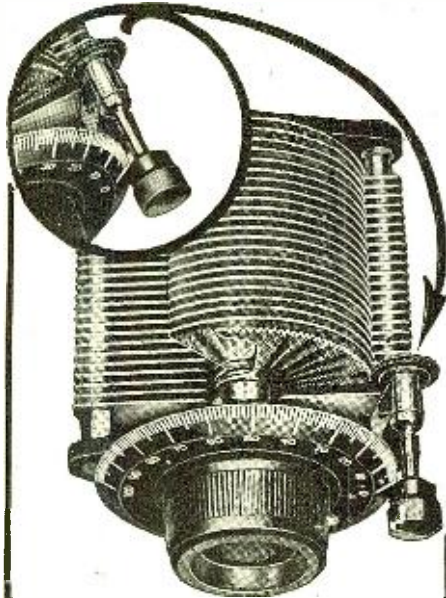

HEATH'S Radiant Condensers

Heath Radiant Condensers will tune as perfectly years later as they do the day you install them. The plates (which in other condensers buckle and get out of alignment), in Radiant Condensers are permanently FLAT by a patented process. They are pressed into absolute flatness and then tempered, so that they can never lose that flatness! Look for the Radiant trade-mark, impressed on every rotary plate of Heath's Radiant Condensers.

Vernier, Geared Like a Watch

Adjusting knob geared to vernier plate so that an ordinary turn is reduced to micrometer fineness. Positive, accurate, durable. No play. Separate tension adjustment.

Write for illustrated booklet and name of the nearest Radiant Dealer.

LIST PRICES VERNIER TYPE

- 13 Plate including 2 1/2" dial and knob.....\$5.00
- 25 Plate including 2 1/2" dial and knob.....\$5.50
- 45 Plate including 2 1/2" dial and knob.....\$6.50

Jobbers and Dealers

Write Immediately for Proposition

HEATH RADIO & Elec. Mfg. Co.

206 First Street
NEWARK, N. J.

WE REPAIR All Standard Makes of RADIO TUBES

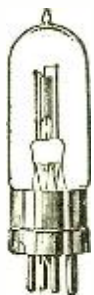

- Including
- W.D.11 or W.D.12.....\$3.50
 - U.V.200 or C.300.....2.50
 - U.V.201 or C.301.....3.00
 - U.V.201A or C.301A.....3.50
 - U.V.199 or C.299.....3.50
 - U.V.202 or C.302.....3.50
 - A & P. or Moorehead Det.....2.75
 - A. & P. or Moorehead Amp.....3.00
 - D.V.6.....\$3.00 D.V.6A.....3.75

Broken glass shells replaced—No extra charge. Eight Hour Service.

All tubes guaranteed and returned Parcel Post, C.O.D.

RADIO TUBE REPAIRING CO.
Hudson Terminal Bldg., 30 Church Street,
Room 327-E New York City, N. Y.



PHONOGRAPH ADAPTER
Victor, Columbia and similar
Phonographs—any Receiver Cap.
Made of brass, nicely nickelled.

Thirty Cents Postpaid
STRAMCY PRODUCTS
716 Clifton Ave., Newark, N. J.

the pointer at your right toward the "Loud" position. CAUTION—When through using the instrument always turn the switch in the center of the panel to the "OFF" position and bring back the pointer on your left to the "Soft" mark.

The standard aerial designed for this set and without which its operation could not be guaranteed as uniform, consisted of two 8' lengths of hollow copper tubing of 2" outside diameter, with 3/32" wall arranged as shown in Fig. 5.

Recently this set was delivered to its new owner and as this was the writer's first attempt to standardize and simplify a radio set for the particular use of the novice, it was interesting to watch the way in which the new owner tackled the job of operation.

When the set was completely installed he was instructed to "start operating." As hoped for, he first carefully read the directions and as he had agreed not to ask any questions of the writer unless he failed in his task, he set the dial to "WOC-DAVENPORT." Then he turned the switch to the "ON" position. No response! Station WOC was evidently not "on the air." Next he moved the dial to station KYW. There was some whistling as he slid into the resonant point, but this only lasted for the fraction of a second. KYW was broadcasting its regular evening concert, but the reception was rather dim. Almost immediately he sought the "Loud" pointer, and turned it over until the music flooded the whole house.

The writer is satisfied, from this and ensuing experiments, that there is a distinct market for sets which are less complicated than any which are on the market today. He believes that the idea of marketing a radio set on the DX argument alone is decidedly faulty and that the utilitarian value of radio has been sadly neglected.

Unless popular radio is to be forever classed as a hobby of the tinkerer, or the medium of expression for the mechanically inclined youth of America, it is time we set about to make it a product of utilitarian value to all.

Canadian Station 9BP Reaches Arctic

(Continued from page 707)

been taken ashore in case of accident, the members of the expedition are living aboard and will continue to do so. There is, however, danger that the ship may be crushed by the ice and in that case it will be necessary to move their headquarters to shore. A new aerial and counterpoise for the transmitter are now being rigged up.

CONDITIONS IN THE FAR NORTH

In telling of the conditions of the country in the far north, the operator stated that early in September there was a foot of snow on the ground, and ice was beginning to form in the harbor. The temperature was 22 degrees F. They are in the midst of the country where members of former expeditions perished, including 17 members of the Greeley expedition, who died of starvation in 1884. Conditions there are good for the scientific observations they wish to make and the various points they are to visit can easily be reached by dog sledge after the harbor freezes. The party is planning to set up a tablet entrusted to them by the National Geographic Society of Washington and they say they can reach Cape Sabine with their dogs in six hours for that purpose.

Walrus hunting is one of the occupations of the party and they are depending on a

For Sale:

Complete Radio Broadcasting Station

A composite radiophone stations in perfect condition, with 100-ft. antenna; has been heard perfectly as far as coast of France, and in Cuba. Complete in every particular with speech amplifiers, amplifier batteries and table with field rheostats.

This is the same station that we have used in broadcasting for the past several months and is high-grade in every respect.

A splendid buy for a church, organization or commercial establishment desiring to enter the broadcasting field.

Woodward & Lothrop
Washington, D. C.

Here It Is!



Send for it
NOW

LUDWIG HOMMEL & CO.
530-534 FERNANDO ST. PITTSBURGH, PENNA.



GERMAN MAUSER

Reg. price \$25.00

\$11.50
25 Cal.

32 cal. \$12.50

WITH PERFECT SAFETY DEVICE

Guaranteed Genuine Latest model 9 shot automatic. Shoots Standard cartridges—lies flat in the pocket—World's famous Luger 30 Cal. \$15.50. Hand Ejector Revolver, swing out cylinder 32 cal. \$15.50, 38 cal. \$16.50. All brand new latest models—guaranteed genuine imported.

SEND NO MONEY Pay postman on delivery plus postage. Satisfaction guaranteed or money promptly refunded.

\$6.00 25 Cal. Vest Pocket Automatic—25 cal. Blue Steel Army Automatic \$7.85. 32 Cal. \$10.25. Military Trench Automatic—32 cal. 20 shot, extra magazine F.R.E. \$5.50. Imported Top Break Revolver, 32 Cal. \$8.25, 38 Cal. \$8.25.
UNITED SALES CO., 12 East 22nd St. Dept. 255 New York

supply of walrus meat for their subsistence during the winter months. Up to the beginning of September they already had the meat of five walrus packed away under rocks on shore as a base of supplies and this was being increased from time to time as opportunity arose.

The object of the expedition you will know is in the interest of science, to study the flora and fauna of the northland and to gather data on magnetic phenomena. A magnetic observatory was set up on shore for this purpose soon after the arrival of the ship, and regular observations are being taken which will prove of great value from a scientific viewpoint.

A cairn was discovered on the west side of Refuge Bay by the explorers. This cairn was erected 70 years ago by the first American Arctic explorer, Dr. Elisha Kent Kane. Here he celebrated reaching the point farthest north in Smith Sound by a simple little ceremony, that of waving a flag made from his cap lining, in lieu of the Stars and Stripes. This was bound to his gun ramrod. The flag was found in 1914, 61 years later, under an iron pot a few miles north of the expedition's present location.

Wood is very precious in the far north. The wood used by the expedition in the building of a large and comfortable house at Etah in 1914 they found had been completely demolished and all that was left to indicate a former habitation were some rusty cans and scrap iron. All wood had disappeared.

THE AMATEUR HAS AGAIN SUCCEEDED

Before the *Bowdoin* left Wiscasset, Maine, on June 23 last for her 14-month trip to the top of the world, it was announced that she would endeavor to keep in touch with the outside world by amateur radio and this she has been enabled to do through my station. Other polar expeditions have carried radio apparatus and failed to keep in communication. But where commercial radio has failed, the amateurs have succeeded.

ATMOSPHERIC CONDITIONS IMPROVING

During the summer months there was continuous light fading into twilight, but never getting dark. This made radio work difficult, but with the coming of winter with continuous darkness the radio conditions should improve materially and no doubt communications will be established by the *Bowdoin* with other stations, probably before this is published. Mix expressed a wish to be able to work other stations so as to take part of the load of this one and thanked me heartily for listening for him nightly and relaying the messages which he sends me to be forwarded. At the time of writing he was just beginning to hear broadcasting stations loud enough for a loud speaker. The stations that he was able to get best were KFJ, KFI, WJAZ, WDAP, and WQAW. The call letters of amateur stations heard by Mix up to September 20, were as follows:

CALLS HEARD BY OPERATOR DONALD H. MIX ABOARD SCHOCNER "BOWDOIN"

HEARD AT GODTHAAB, GREENLAND, JULY 28TH TO 31ST (CK6):—1CCZ, 8APN, 8BJZ, 8DCZ, 8OE, 9ATY.

HEARD JULY 31ST AND AUGUST 1ST, 65 NORTH LAT. 53 WEST LONG (CK11):—1CRE, 2BOH, 3APR, 3ZS, 8BDU, 8BXX, 8CED, 8DLA, 8PX, 8 NB, Canadian 1DD.

HEARD AUGUST 1ST, 66 NORTH LAT. 55 WEST LONG. (CK4):—3ZS, 8NB, 8PX, 9APS.

HEARD AUGUST 2ND AND 3RD 69 NORTH LAT. 55 WEST LONG. (CK5):—1CMP, 1EE, 2AXK, 3ZM, 8AME.

HEARD AUGUST 3RD 71 NORTH AT. 56 WEST LONG. (CK8):—1AQM, 1BAC, 1UH, 2AWF, 2CQZ, 8CGU, Canadian 3DJ, Canadian 3GK.

HEARD AUGUST 6TH AND 7TH 77 NORTH LAT. 71 WEST LONG. (CK11):—1AJP,

LEICH RADIO PRODUCTS

\$6.00 Headphones of Sterling Quality.

Telephone instrument manufacturers of long experience offer radio buyers, Headphones that have been brought to a high state of efficiency in the successful manufacturing of voice transmission equipment.

Leich Radio Headphones with Eureka Headband are light in weight, comfortable, and durable. Bakelite caps and metal containing cups guard the accurate adjustment necessary to maintain a sensitive instrument. Approved by Radio News Laboratories, Certificate No. 244.



1-R—2000 ohm Headphone \$6.00

L-Radio Plugs are made in single and two phone type. Barrel easily removable, by taking off only one knurled thumb nut.

- No. 60 Single Phone L-Radio Plug.....\$.90
- No. 61 Two phone series L-Radio Plug.....\$1.00

Approved by Radio News Laboratories Certificate No. 245.

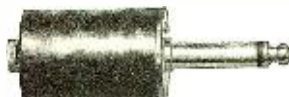

L-Radio Plug

L-Radio Jacks furnished in two spring series, two spring open circuit and double cut-off. A compact, inexpensive jack that mounts in a small space.

- Desirable jacks for interstage coupling, headphones and jack box.
- 38-A Open circuit L-Radio Jack.....45c
- 38-B Double cutoff L-Radio Jack.....65c
- 38-D Series circuit L-Radio Jack.....50c

Approved by Radio News Laboratories Certificate No. 246.



L-Radio Jack

Non Tune Radio Rectifier.

Inexpensively charges radio batteries at home. Costs less than a 40 watt lamp to charge a 6 volt battery. Charge either day or night.

Patented relay lock protects machine and battery during power interruptions.

Especially suitable for low capacity storage batteries. Supplied to charge 4 and 6 volt batteries.



No. 16 Non Tune Rectifier \$19.00

Booklet 101-H lists additional accessories.

Buy from your dealer or order direct.

LEICH ELECTRIC CO. - Genoa Ill.

SUPER VALUES

List Price	Phones	OUR PRICE	List Price	Condensers	OUR PRICE
\$55.00	WESTERN ELECTRIC 10-D		\$1.30	3 PLATE VERNIER	\$.90
30.00	MUSIC MASTER		5.00	23 PLATE VERNIER	2.50
25.00	ATLAS AMPLITONE		5.50	43 PLATE VERNIER	2.75
28.50	DICTOGRAND		3.00	23 PLATE PLAIN	1.50
			2.80	43 PLATE PLAIN	1.90
List Price	Genuine R. C. A. Tubes	OUR PRICE	List Price	Audio Transformers	OUR PRICE
\$8.00	RADIOTRON U.V.200	\$3.95	\$4.50	ALL AMERICAN 3 to 1 Ratio	\$3.95
6.50	RADIOTRON U.V.201A	5.75	4.75	ALL AMERICAN 5 to 1 Ratio	4.10
6.50	RADIOTRON W.D.11	5.75	4.75	ALL AMERICAN 10 to 1 Ratio	4.10
6.50	RADIOTRON W.D.12	5.75	7.00	AMERTRAN	5.55
6.50	RADIOTRON U.V.199	5.75	7.00	FEDERAL No. 65	5.55

All Mail Orders Shipped Promptly.

Send Money Order, including Postage.

Write for Our Catalogue D.

HANES-ZENER CO., 3 West 29th Street, New York City

The RADIO MAIL ORDER HOUSE—Known For Low Prices

The Greatest Book on RADIO ever written

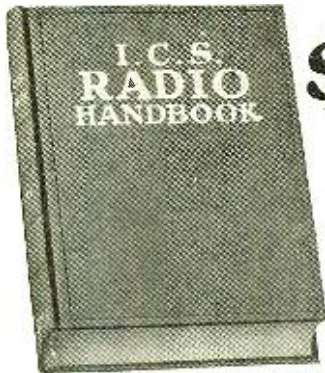

only **\$1**

514 pages Pocket Size

Compiled by HARRY F. DART, B.S.E.E. Formerly with the Western Electric Co., and U. S. Army Instructor of Radio Technically edited by F. H. DOANE

JUST off the press! The greatest book on radio ever written. Price only \$1. Filled with sound, practical, tested information for every radio fan, from beginner to hard-boiled owl. Written, compiled and edited by radio experts of national reputation.

Every page tells you something useful. And there are 514 pages! More than 150 illustrations and diagrams!

You may dip into this I. C. S. Radio Handbook at random, or hunt up special information you want, or read it right through. Different types of receiving and sending hook-ups are explained; proposed insurance regulations; lists of broadcasting stations; radio compass stations; interesting experiments; definitions; codes and symbols; technical data and thousands of suggestions for getting more pleasure out of radio. Will save you from wasting money on things that won't work.

Send \$1 to-day and get this 514-page I. C. S. Radio Handbook before you spend another cent on parts. Money back if not satisfied.

TEAR OUT HERE

INTERNATIONAL CORRESPONDENCE SCHOOLS
Box 8284, Scranton, Penna.

I enclose One Dollar. Please send me—post-paid—the 514-page I. C. S. Radio Handbook. It is understood that if I am not entirely satisfied I may return this book within five days and you will refund my money.

Name.....
Address.....

Save Money By Mail

- Brandes Phones, Genuine\$5.25
 - Neroo Phones 3.00
 - \$16.00 Westinghouse Rectigon Charger 14.03
 - \$1.75 B Batteries 22½ V. small75
 - \$3.00 B Batteries 22½ V. large 1.45
 - \$4.00 Thoradson Transformers, low ratio 3.25
 - \$4.50 Thoradson Transformers, high ratio 3.75
 - Ford Transformers, high ratio 3.25
 - Ritter Portable K. D. Loop 1.00
 - \$7.00 Pioneer moulded bakelite variocoupler 4.95
 - \$6.50 Pioneer moulded bakelite variometer 4.85
 - 180° Variocoupler with spider web rotor, silk wound 3.50
 - 13 plate Condensers 1.25
 - 23 plate Condensers 1.50
 - 43 plate Condensers 1.75
 - 3 plate Vernier Condensers75
 - Soldering Irons, small tip 2.50
 - Freshman Variable Leak—50c. with Condenser65
- Merchandise absolutely guaranteed shipped immediately on receipt of purchase price and postage.

MARVEL RADIO SPECIALTY CO.
132 Nassau St., Dept. RN., New York

1AYZ, 1BRO, 1TS, 2BUM, 2CUR, 2CDX, 33DO, 3BN, 8CSJ, 9DEC.

HEARD AT REFUGE HARBOR, GREENLAND, LAT. 78.30, NORTH LONG. 72.30
FIRST DISTRICT (CK18):—1ABS, 1ACU, WEST, AUGUST 8TH TO SEPTEMBER 20TH
1ALJ, 1ANA, 1ARF, 1AW, 1BBO, 1BCG, 1BES, 1BVR, 1CDM, 1CKP, 1CPO, 1ER, 1FB, 1FM, 1UJ, 1ZE.

SECOND DISTRICT (CK21):—2ACD, 2AFP, 2AGB, 2AJW, 2ALM, 2AWH, 2BRB, 2BRC, 2BSC, 2BYC, 2BZV, 2CBC, 2CBG, 2CJL, 2CLA, 2COA, 2OM, 2RB, 2RS, 2WR, 2FP.

THIRD DISTRICT (CK10):—3AB, 3APT, 3BFU, 3BG, 3BVA, 3BVL, 3IW, 3ME, 3VO, 3ZO.

FOURTH DISTRICT (CK9):—4BY, 4CH, 4FT, 4GL, 4GX, 4HS, 4KU, 4QU, 4RH.

FIFTH DISTRICT (CK46):—5ACR, 5ADB, 5ADO, 5AEC, 5AEU, 5AGJ, 5AIC, 5AJI, 5AIU, 5AJJ, 5AKN, 5AKY, 5ALR, 5AMA, 5BM, 5DW, 5EK, 5FC, 5GA, 5GE, 5GM, 5GP, 5HL, 5IN, 5JF, 5KY, 5LG, 5LL, 5LR, 5MM, 5MN, 5NN, 5NS, 5NU, 5PB, 5QE, 5QO, 5QR, 5RM, 5UK, 5UO, 5VA, 5WG, 5XV, 5ZA, 5ZAV.

SIXTH DISTRICT (CK83):—6AAK, 6ABK, 6AC, 6ACG, 6AGE, 6AIV, 6AJD, 6ANB, 6AOL, 6AOS, 6AOU, 6APH, 6ARB, 6ATC, 6AVV, 6AWT, 6BBC, 6BBH, 6BBW, 6BCL, 6BGV, 6BGY, 6BIC, 6BIH, 6BIO, 6BKH, 6BLV, 6BLY, 6BOU, 6BPZ, 6BQB, 6BQC, 6EQL, 6BRF, 6BOU, 6BVE, 6BVG, 6BVS, 6BWZ, 6CAI, 6CAT, 6CBU, 6CCD, 6CCY, 6CET, 6CFI, 6CFZ, 6CGD, 6CGW, 6CHE, 6CHL, 6CHV, 6CID, 6CKF, 6CKH, 6CKP, 6CML, 6CMR, 6CMU, 6CNL, 6DD, 6ET, 6FH, 6FY, 6HP, 6HV, 6JX, 6KA, 6KM, 6NB, 6PL, 6RM, 6TU, 6TV, 6UA, 6UO, 6UX, 6VK, 6ZAH, 6ZAR, 6ZK, 6ZP, 6ZX.

SEVENTH DISTRICT (CK48):—7ABF, 7AIC, 7ACM, 7ADP, 7ADR, 7AEL, 7AGI, 7AGV, 7AHV, 7AK, 7BG, 7BJ, 7BR, 7CF, 7DC, 7EI, 7FD, 7GE, 7GI, 7GO, 7GP, 7HG, 7IO, 7IV, 7JE, 7KS, 7KV, 7LH, 7LN, 7LR, 7LY, 7OY, 7SF, 7SZ, 7TK, 7TO, 7TQ, 7UD, 7WE, 7WM, 7WS, 7YA, 7YL, 7ZD, 7ZF, 7ZL, 7ZN, 7ZU.

EIGHTH DISTRICT (CK69):—8AAB, 8AAJ, 8AB, 8ADA, 8AEG, 8AFP, 8AIO, 8AMP, 8AMM, 8AMP, 8ANP, 8APT, 8APY, 8AQ, 8AQO, 8ASV, 8AVD, 8AVN, 8AWP, 8BBI, 8BCI, 8BDA, 8BDU, 8BDV, 8BFH, 8BJV, 8BLX, 8BVT, 8BXH, 8CCR, 8CDD, 8CDZ, 8CEL, 8CKO, 8CPP, 8CQH, 8CRB, 8CTP, 8CUR, 8VCU, 8CXM, 8CYZ, 8DAT, 8DID, 8DJD, 8EJF, 8DKM, 8ES, 8FT, 8GZ, 8HN, 8HV, 8IG, 8IJ, 8KG, 8KJ, 8RJ, 8RY, 8UF, 8UK, 8VN, 8VO, 8VT, 8VW, 8VY, 8XH, 8YV, 8CZ, 8ZZ.

NINTH DISTRICT (CK180):—9AAL, 9AAO, 9AAV, 9AAW, 9ACK, 9AEC, 9AHJ, 9AHZ, 9AIC, 9AIM, 9AJA, 9AJH, 9ALB, 9ALX, 9AMF, 9AMI, 9AML, 9AMS, 9AOG, 9APE, 9APP, 9APV, 9APW, 9AOG, 9ARC, 9ARZ, 9AUA, 9AU, 9AVC, 9AVI, 9AVN, 9AVI, 9AOK, 9AVZ, 9AWG, 9AWK, 9AXX, 9AYL, 9AZX, 9BAF, 9BAN, 9BAV, 9BBW, 9BDV, 9BDH, 9BDS, 9BE, 9BEZ, 9BFI, 9BHC, 9BCH, 9BDH, 9BHO, 9BJK, 9BK, 9BKK, 9BKR, 9BMU, 9BMX, 9BPV, 9BOJ, 9BOO, 9BOY, 9BRK, 9BRS, 9BRX, 9BSG, 9BSZ, 9BTL, 9BTT, 9BUN, 9BVO, 9BWF, 9BXC, 9BYC, 9BYT, 9BZE, 9BZI, 9CAA, 9CAH, 9CAJ, 9CCS, 9CCZ, 9CDR, 9CDV, 9CE, 9CFK, 9CFY, 9CGA, 9CH, 9CHC, 9CIL, 9CIP, 9CJS, 9CKA, 9CKS, 9CLN, 9CTE, 9CTN, 9CTV, 9CVC, 9CVI, 9CVO, 9CVS, 9CXH, 9CXO, 9CZW, 9DAT, 9DAW, 9DBH, 9DCR, 9DCT, 9DCW, 9DDJ, 9DEK, 9DGE, 9DGV, 9DVG, 9DHG, 9DHN, 9DHP, 9DHS, 9DJB, 9DKI, 9DKO, 9DKY, 9DLI, 9DOC, 9DOE, 9DOF, 9DPE, 9DOE, 9DQH, 9DOM, 9DOU, 9DRK, 9DRO, 9DRR, 9DSW, 9DTE, 9DWM, 9DXR, 9DYZ, 9DZY, 9EAE, 9EBP, 9EBT, 9EBA, 9EEV, 9EHN, 9EIV, 9EKF, 9EKT, 9EKY, 9ELB, 9ELD, 9ES, 9AD, 9GK, 9HK, 9HM, 9HW, 9IG, 9IH, 9JF, 9LZ, 9MC, 9MF, 9NU, 9PN, 9QI, 9UC, 9UH, 9XN, 9ZG, 9ZT, 9ZY—9BDH Spark.

CANADIAN STATIONS (CK14):—2BN, 2CG, 3BP, 3NI, 3XN, 4CL, 4DQ, 4ER, 5CN, 5CT, 5GO, 5HB, 5HG, 9BP.

ALASKA STATION:—7IT.
HAWAII STATION:—6CEU.
MEXICO STATION:—J.H.

A POSSIBLE DANGEROUS REVOLUTIONARY PLOT

A possible and dangerous revolutionary plot. Reliable and positive information of a gigantic revolutionary plot, based upon the alleged secret possession by the revolutionists of radio apparatus that enable them to hypnotize and read people's thoughts at a distance has been furnished us. It is alleged that with it, in the last four years, the revolutionists have learned the secrets, and political attitude of every prominent person, and by radio hypnotism have forced everyone to distinguish themselves and their business with the colors red or green. The homes, roofs, business fronts, trucks, and even advertising, of 100 per cent Americans are

"S-O-S"

Not a distress call, but a nick-name for a happy little time-and-trouble-saving device, that is selling like hot-cakes everywhere.



CHASLYN

Sinkor Swim Ball Battery Testing Set Sent **\$1.00** postpaid anywhere for

Tests battery acid instantly, by the way three balls sink or swim in a glass barrel. Reads at a glance; not necessary to remove it from the cell. No more acid-burned clothes, hands or carpets.



Sinkor Swim The Chaslyn Boy

A Boon to Motorists

A Necessity to Radio Owners

Set includes Ball Hydrometer, Depth Gauge and Water Filler, all packed in a handy fibre cylinder.

THE CHASLYN CO.

Dept. 1 3845 Ravenswood Ave., CHICAGO, ILL.

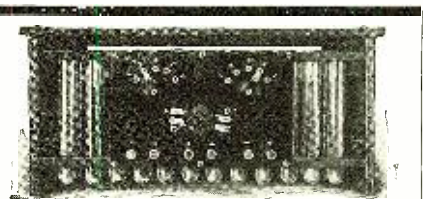

"Satisfaction increasing; customers want more"

That's the message that came across the continent with an order from an Oregon distributor. KICO Batteries always make good. Alkaline type, won't sulphate or buckle. Life unlimited. Not harmed by short circuiting, overcharging, idleness. Panel switches give single cell variations. Recharge from any 110-volt A. C. line with small home rectifier. Charge lasts 3 to 6 mo. in detector plate circuit.

Cells	Volts	Price	With
		\$5.50	panels
16	22	\$5.50	\$
24	32	7.25	11.75
36	48	9.50	14.00
50	68	12.50	17.00
78	100	17.50	22.50
108	145	23.50	28.50

GUARANTEE

Your money back on any KICO Battery if not satisfied after 30 days' trial. Write for full information on "A" and "B" Batteries.

KIMLEY ELECTRIC COMPANY, Inc.
2665 Main Street Buffalo, N. Y.

KICO Storage "B" Batteries

—long service, low cost

BROWNLIE CRYSTAL

FOR REFLEX OR CRYSTAL SETS **50¢**

"CLEAR AS A BELL"
Guaranteed Sensitive from Edge to Edge. Withstands Heavy Plate Voltage. Endorsed and Sold to the Leading Makers of Reflex and Crystal Sets. Order From Your Dealer or Direct
ROLAND BROWNLIE, Manuf'r.
22-24 Saunders Street, Medford, Mass.

red, while that of the revolutionists is blue or green. Thus Americans may be discriminated against and their business destroyed, and later when the actual revolution (following a railroad strike) takes place, no mistakes will be made. Will you kindly hand this card to your newspaper, and answer the following questions? Is thought and nervous action electrical. If so, would ether waves be radiated? Could these ether waves be caught on an aerial and amplified with vacuum tubes? Will you mail us your reply?

Evidence indicates revolutionists use long wave-lengths of 200 frequency in broadcasting hypnotic waves. Can you tune in on this frequency and detect their carrier wave?

SPECIAL COUNCIL OF DEFENSE.
H. F. Dunn, Sec.,
824 N. East St., Indianapolis, Ind.

Fellows, this is not a joke. We actually received a post card on which the above text was printed. We suggest that you draw your own conclusions. Hi!—EDITOR.

Calls Heard

9ZT, MINNEAPOLIS, MINNESOTA
C.W.: (1AW), (1ER), 1IZ, 1UH, 1ABC, (1ABS), 1ACU, (1ADN), 1AIP, 1AKE, (1AVA), 1BBC, (1BCF), (1BCG), 1BKO, 1BOM, 1BST, 1BVB, 1WJ, 1CKP, (1CMP), (1CPO), (1CRW), 2FP, (3CK), 2RB, 2RM, 2RS, 2AFP, (2ACB), 2AWH, 2BMR, 2BOH, (2BRB), 2BSC, 2BVC, 2CCX, (2CFB), (2COZ), 2CVU, 3GS, 3HH, 3IW, 3TJ, 3TM, 3ABW, 3BJJ, 3BVA, (3BVL), 3CCU, (3CHC), 4AF, (4AI), (4CS), 4DX, 4EB, 4FT, (4KU), 4MB, (5FX), 5GA, 5GE, (5GD), 5GN, (5LR), 5MN, 5MO, 5PB, (5QL), 5OO, 5SP, 5UO, 5VK, (5ZA), 5ABN, 5AFN, 5AJ, 5AIC, 5AII, (5AKN), 5AMA, (5AMB), 5ANF, 5XAD, (5ZAV), (5ZAN), 6EC, 6HP, (6KM), 6PL, 6ACG, (6AGE), (6AJD), 6ALK, (6ALV), (6AOS), (6ARB), 6ATZ, (6AWS), (6AWT), 6BKN, (6PZ), (6BOB), (6BRF), (6BRU), 6BUO, (6BVG), 6BVN, 6BYU, (6BCU), (6CFZ), 6CGI, 6CGW, (6CHL), (6CPI), 6CPZ, (7BI), (7DC), 7DW, (7DF), (7LY), 7WP, 7YA, 7YL, (7ZD), (7ZF), 7ZL, (7ZN), 7ADP, (7AEF), (7AGV),
Canadian: 2BN.

9DHJ, CROWN POINT, IND. (1 Tube)
CW, 2AGE, 3CEL, 3CFU, 3IO, 3TJ, 3TR, 4EO, 4GX, 4KC, 4KU, 4MI, 4NA, 4OL, 4XA, 5NL, 5SG, 5UP, 8JA, 8CX, 8DO, 8GG, 8HV, 4IG, 8JJ, 8KR, 9PL, 8RG, 8VL, 8WL, 8AAP, 8AHO, 8ADA, 8ANN, 8BWN, 8BDJ, 8BRM, 8BSY, 8COH, 8CUE, 8DAK, 8DCB, 8DON, 8DKM, 9AV, 9AX, 9BV, 9CE, 9CP, 9CR, 9CZ, 9HK, 9LT, 9MC, 9MF, 9OX, 9LO, 9OG, 9UC, 9US, 9ZI, 9ZV, 9ZY, 9APV, 9ACJ, 9AAU, 9AXD, 9AWZ, 9AU, 9AIR, 9AIM, 9AWG, 9AVN, 9AAR, 9AEM, 9AAL, 9AIE, 9ALJ, 9AHO, 9AWM, 9AOG, 9AOY, 9ARP, 9AJH, 9AMU, 9AUS, 9AIC, 9AZY, 9AHY, 9AON, 9AOS, 9BRK, 9BEH, 9BGY, 9BSH, 9BTO, "9BON", 9BQO, 9BON, 9BZI, 9BAO, 9BFB, 9BAK, 9BOI, 9BED, 9BMO, 9BSM, 9BTD, 9BBR, 9BTR, 9BBG, 9BKO, 9BWP, 9CPI, 9CAS, 9CAH, 9CEJ, 9CCS, 9CFK, 9CVS, 9CVV, 9CTE, 9CGT, 9COW, 9CCN, 9CTT, 9DEK, 9OSS, 9DGE, 9DKY, 9DRO, 9DMJ, 9DMU, 9DCW, 9DCR, 9DAW, 9DIH, 9DOY, 9DIW, 9DHN, 9DYL, 9DYT, 9DON, 9DHG, 9DTJ, 9DIS, 9DZY, 9DHU, 9EFZ, 9EBA, 9ECB, 9EKF, 9FLB, 9ORG.
Spark: 8WA, 8AVP, 9RC, 9QV, 9WX, 9WY, 9AAW, 9ARM, (CED), 9DBB, 9OIL.
Tone: 9CP.

2CTN, RICHMOND HILL, L. I. (ONE TUBE)
1BCU, 1CRW, 1CPN, 1BWJ, 1AZJ, 1IV, 1BVC, 1AWT, 1CDM, 1JV, 1AUR, 1AKR, 1AHL, 1CCZ, 1BES, 1BOK, 1RR, 3CDN, 3BVA, 3CDK, 3IV, 3AIG, 3BUY, 3CEG, 3OO, 3AUV, 3BDQ, 3CBL, 3BOT, 3BWJ, 3BLC, 3AHP, 3BVL, 3CCU, 3BTA, 3BMV, 3BON, 3CBL, 3RSB, 3ZO, 3AGB, 3CFV, 3CC, 4FT, 4HS, 4RH, 4EO, 4CG, 4AG, 5AA, 5AMF, 5AE, 5KG, 5NK, 5RE, 5EK, 5UP, 5GZ, 5CTP, 5BHF, 5BNH, 5ALF, 5AVD, 5BDA, 5VO, 5 CTN, 5BV, 5ZF, 5PL, 5BF, 5HV, 5BUX, 5SF, 5AMZ, 5BK, 5AGW, 5DKI, 5DGR, 5DBP, 5DAC, 5CYT, 5ZA, 5BSI, 5AWG, 5EDO, 5DGV, 5CWG, 5EAD, 5WV, 5DEK, 5ROY, 5DKY, 5UM, 5RMU, 5PW, 5DWF, 5DFW, 5BSI, 5CZS, 5AXZ, 5AXX, 5RIZ, 5OX, 5AJH, 5ELD, 5DXN, 5APS, 5AAU, 5PW, 5SG.
Canadian Stations: 3OJ, 3IV, 3TF.

5BD, ARLINGTON, TEXAS
1AJP, 1BCG, 1CPN, 3ADB, 3JY, 3TY, 4AI, 4BK, 4BY, 4DL, 4DX, 4EB, 4EL, 4EO, 4FS, 4PT, 4GN, 4GW, 4GX, 4HR, 4HS, 4JZ, 4MB, 4MI, 4MY, 5's too numerous; 6AFH, 6AFP, 6AJP, 6ALV, 6ARB, 6AVV, 6AWT, 6BBH, 6BHW, 6BIC, 6BIH, 6BM, 6BVS, 6CBU, 6CFZ,

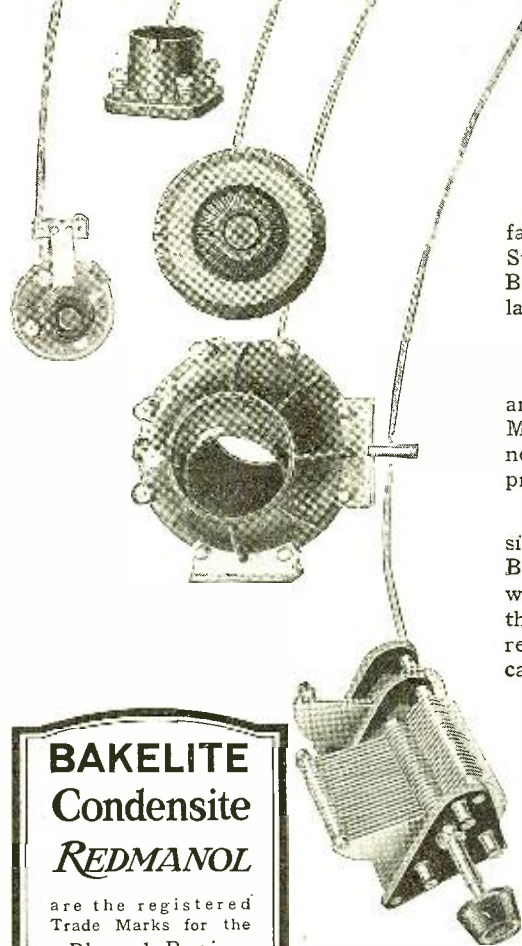
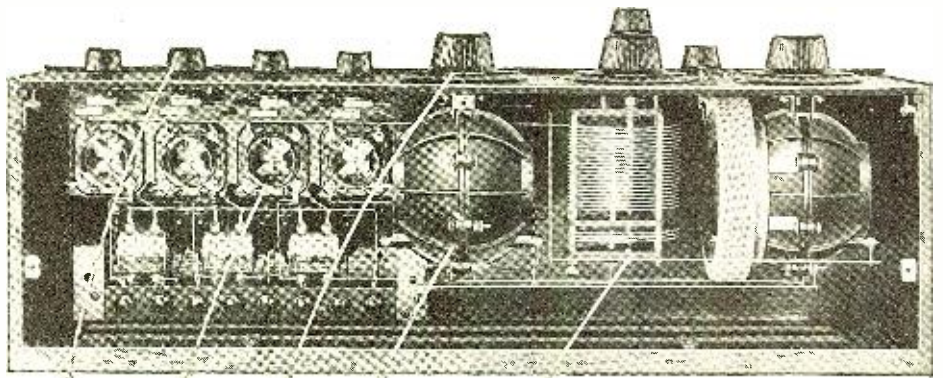

BAKELITE
Condensite
REDMANOL
are the registered Trade Marks for the Phenol Resin Products manufactured under patents owned by **BAKELITE CORPORATION**

Kellogg and BAKELITE

In the Jones' Symphony Set, manufactured exclusively by the Kellogg Switchboard and Supply Company, Bakelite insulation, in both molded and laminated forms, is used throughout.

Bakelite has been adopted as standard insulation by the leading Radio Manufacturers, because of the permanence of its dielectric and mechanical properties and its changeless color.

The careful manufacturer and designer of radio apparatus chooses Bakelite because of his confidence that wherever and whenever it is used in the future it will maintain the SAME resistivity which figured in his design calculations.

Because of its high temperature resistance and its non-absorbent properties, Bakelite performs equally well in all climates and under all atmospheric conditions.

Send us your name and address and we will mail you a copy of our Radio Booklet B.

BAKELITE CORPORATION
Address the Divisions
General Bakelite Company, 8 W. 40th St., N. Y.
Condensite Co. of America, Bloomfield, N. J.
Redmanol Chem. Prod. Co., 636 W. 22d St. Chicago

THE MATERIAL OF A THOUSAND USES

Loud Speaker \$1
Radio Adapter
Hear all broadcasting through phonograph. Make your own horn. Attach B-R Phonadapter to YOUR phonograph. All can hear. Entire family, neighbors, guests can hear operas, lectures, latest news, with this adapter. Stretches over receiver of any standard type head-set and attaches to tone-arm of ANY phonograph. Made of soft, pure gum rubber. Quickly attached and removed. Thousands in use. Will not amplify or distort. For single receiver **50c**. For pair of receivers (more than twice the volume) \$1.
Go to your dealer. If he cannot supply you send money order, check or currency at our risk. Prompt delivery—postpaid. Also send us name of favorite radio dealer.
The Beckley Ralston Company
1803 So. Michigan Ave., Chicago, Ill.

RUSONITE
CRYSTAL RECTIFIER
(Patent Pending)
THE PERFECT SYNTHETIC CRYSTAL DETECTOR SENSITIVE OVER ENTIRE SURFACE
No Hunting for "Spots." Loud and Clear. Endorsed by Thousands of Satisfied Users.
Sensitiveness Price **50c**
Guaranteed Mounted
14 K. Gold Supersensitive
RUSONITE CATWHISKER. Price 25c
Permanent. Will not Oxidize.
RUSONITE REFLEX CRYSTAL
Manufactured Expressly for Reflex Circuits Will Stand Up Under Heavy Plate Voltage
Guaranteed Price Mounted **\$1.00**
Order from your dealer or direct from
RUSONITE PRODUCTS CORP.
15 Park Row New York, N. Y.



resistant!

BDXX is highest in dielectric strength — much higher than ever required in radio. Perfect for panels!

bakelite dilecto!!

(A Laminated Phenolic Condensation Material)

It is the only good insulator having amazing mechanical strength — yet readily machinable like metals.

Tough, durable, super-resistant. Resists water and solvents. Won't warp. Ask any electrical man to get Bakelite-Dilecto (xx grade) cut to size for you.

The Continental Fibre Co.,
Factory: Newark, Delaware.

Dealer Service From:

New York, 233 Broadway
Chicago, 332 S. Michigan Ave.
Pittsburgh, 301 Fifth Ave.
San Francisco, 75 Fremont St.
Seattle, 1041 Sixth Ave., South
Los Angeles, 411 S. Main St.

XX

HYGRADE SPECIALS

- 200 ft. 7 strand No. 22 Copper aerial wire...\$1.25
- Morse Eureka Test Clips, per dozen..... .50
- Skinderviken Transmitter Buttons..... .95
- No. 763 Eveready 22 1/2 V. Variable B. Bat. 1.25
- No. 766 Eveready 22 1/2 V. Variable B. Bat. 1.98
- No. 767 Eveready 45 V. Variable B. Battery... 3.98
- 2000 Ohm Murdock No. 56 Head Sets..... 3.50
- 3000 Ohm Murdock No. 56 Head Sets..... 4.25
- Federal or Brandes Head Sets Complete... 5.50
- Dictograph 3000 Ohm Head Sets..... 5.98
- Fada or Framingham Rheostats..... .65
- Acme Amplifying Transformers..... 3.75
- Acme R. F. Transformers, Types R2-R3-R4 3.98
- 6 Volt Marko Storage Batteries..... 8.95
- Fireco (Bull Dog Grin) Phone Plugs..... 7.5
- Federal Amplifying Transformers..... 4.75
- 23 Plate Var. Cond. Bakelite Ends..... 1.49
- 43 Plate Var. Cond. Bakelite Ends..... 1.95
- No. 164A Fada Neutrotron Condenser..... .98
- No. 163A Fada Neutroformer..... 6.49
- No. 165A Fada Hazeltine Parts..... 21.50

All orders must include Parcel Post charges
Hygrade Electrical Novelty Co.,
41 West 125th Street New York, N. Y.

6CGW, 6HV, 6JX, 6MH, 6PL, 7ADR, 7ZD, 8AFD, 8AGO, 8AMF, 8APN, 8ASV, 8BCL, 8BDU, 8BLX, 8BRX, 8BVT, 8CDD, 8CEI, 8CGX, 8CP, 8CZZ, 8CWU, 8DHO, 8DJF, 8DKM, 8DLA, 8DO, 8GZ, 8HV, 8IJ, 8PL, 8RA, 8TT, 8WY, 8ZAE, 8ZZ, 9AAV, 9AHJ, 9AIM, 9AJE, 9AMB, 9APP, 9AUY, 9AVN, 9BCX, 9BDR, 9BHN, 9BJK, 9BKK, 9BKO, 9BLG, 9BLU, 9BNA, 9BNO, 9BUN, 9CAH, 9CAJ, 9CFY, 9CHD, 9CPU, 9CVC, 9CVO, 9CVS, 9CWC, 9CYO, 9DDP, 9DTZ, 9DOU, 9EAE, 9EL, 9ELL, 9EDO, 9EKY, 9IH, 9LZ, 9MC, 9NA, 9ST, 9US, 9ZT.

Canadian: 3BP, 3CO, 3XN. All cards answered.

8HEB, KALAMAZOO, MICH.
1GV, 1ACU, 1AUR, 1BES, 1BJL, 1CKP, 1CPL, 1CW, 1CKP, 2FP, 2SM, 2WB, 2AGB, 2AGX, 2AMR, 2APD, 2AQQ, 2BJL, 2BNZ, 2BSC, 2CFW, 2CQV, 2CQZ, 3BP, 3DS, 3MK, 3MO, 3NI, 3TH, 3TJ, 3SU, 3UJ, 3TW, 3TB, 3VD, 3VH, 3WF, 3XN, 3YS, 3ZT, 3AFS, 3ATG, 3BDO, 3BMO, 3BOF, 3BUY, 3BPM, 3CDN, 4AG, 4DO, 4OS, 4MB, 4GX, 4CS, 4KC, 4KF, 4ER, 4OM, 4FT, 4EB, 4RX, 4MY, 4KU, 4LI, 4NI, 4NA, 4MI, 4GW, (4UK? ORM), 5NI, 5PV, 5QH, 5MA, 5HL, 5EK, 5LR, 5GA, 5NY, 5ZA, 5KW, 5SG, 5UK, 5KC, 5AM, 5FC, 5JE, 5GI, 5SF, 5ABT, 5ABY, 5ACM, 5AKN, 5AGG, 5AGJ, 5AMB.

Canadian: 3BP, 3KG, 3NI, 3ZS, (9AL?), (3WI? Funny fist).

PORTABLE 6AQF AT IDYLVILD, CALIF.
11A? (1CW), 1BBO, 2TT, 5ADB, 5AKY, 7GO, 7LH, 7AKV, 7AKZ, 8DIG, 9GO, 9AAU, 9BJN, 9BUN, 9BVO, 9CAJ, 9CUC, 9EAE.

5JY, DALLAS TEXAS
2SP, 3AJG, 4BY, 4FS, 4MB, 4DB daylite, 4GX, 4NA, 4EB, 4KU, 4XU, 5's too numerous; 6V, 7ZV, 8AHO, 8BCL, 8CGX, 8FT, 8HV, 8VY, 8AMP, 8BNU, 8CNO, 8GZ, 8PD, 8WX, 8APN, 8CGV, 8DO, 8HU, 8VT, 8ZZ, 9AAL, 9AAW, 9AGY, 9AJH, 9AAR, 9AEP, 9AHZ, 9AMB, 9AAU, 9AGS, 9AIM, 9AMU, 9AOL, 9APV, 9AUY, 9AWF, 9AXX, 9AZX, 9BBW, 9BDS, 9BDF, 9BIK, 9BKW, 9ANY, 9APE, 9APW, 9AVS, 9AWG, 9AYL, 9BAK, 9BCF, 9BEH, 9BHD, 9BJK, 9BKO, 9AOK, 9APS, 9ARZ, 9AVU, 9AWK, 9AYP, 9BAZ, 9BCG, 9BEZ, 9BIS, 9BK, 9BLE, 9BOJ, 9BSH, 9BTI, 9BWR, 9CAH, 9CCZ, 9CIP, 9CPW, 9CVO, 9DAN, 9DFW, 9DHG, 9BRX, 9BSZ, 9BTT, 9BZI, 9CAW, 9CFY, 9CKP, 9CR, 9CVS, 9PCW, 9DGN, 9DLT, 9BSG, 9BTE, 9BUN, 9CCA, 9CCS, 9CHC, 9CKS, 9CTV, 9CWC, 9DFS, 9DGV, 9DMJ, 9DMW, 9DQE, 9DUG, 9DXN, 9EHJ, 9EKY, 9GD, 9HY, 9LZ, 9NU, 9UC, 9ZG, 9DOL, 9DRO, 9DXC, 9EBP, 9EKF, 9FG, 9HK, 9JF daylite, 9NC, 9PW, 9VE, 9ZY.

8GW, XENIA, OHIO
1AJP, 1ALG, 1ARY, 1AYZ, 1BCG, 1RR, 1SI, 2AGB, 2APP, 2ARY, 2BEO, 2BW, 2DS, 2KK, 2VH, 3AWS, 3BEI, 3BML, 3BRF, 3AJ, 3BG, 3IJ, 3SG, 3VW, 4I, 4AY, 4GL, 4GW, 4GX, 4LT, 5GP, 5IX, 5LY, 5MM, 5AEC, 5AO, 9AAW, 9AMI, 9AYL, 9AUS, 9CNL, 9CNO, 9DCR, 9DGE, 9DON, 9DXN, 9DYA, 9EAP, 9ECW, 9EHN, 9ELB, 9EIS, 9ES.
Spark: 2OM, 3BEI, 4GN, 5DA, 9CAV, 9DTN, fone 1AYG.

9BFZ, LA HARPE, ILL.
Cw, 1BES, 1BWJ, 1CMP, 1CPN, 1CVS, 2DX, 2RB, 2WA, 2WR, 2BOC, 2BQH, 2BSC, 2BYC, 2CNK, 2COR, 3GE, 3IW, 3JS, 3MO, 3TB, 3ZO, 3BOF, 3BUV, 4BI, 4CG, 4DO, 4EB, 4FT, 4GW, 4JK, 4KU, 4MB, 4PB, 4RH, 5AV, 5BM, 5DY, 5EK, 5FT, 5GA, 5GL, 5GM, 5GN, 5HL, 5LR, 5MM, 5NK, 5NO, 5PV, 5QL, 5SR, 5UA, 5UK, 5UP, 5WA, 5WV, 5ZA, 5ABT, 5ACR, 5AFO, 5AIU, 5AJP, 5AKI, 5AMA, 5ANB, 5XAB, 5ZAS, 5ZAV, 6VH, 6ZT, 6CFS, 7ZU, 8BF, 8PL, 8UF, 8VO, 8ZO, 8ZZ, 8ABX, 8AGP, 8ALT, 8ALW, 8AMM, 8AVD, 8BCF, 8BCW, 8BKJ, 8BLX, 8BPZ, 8CHB, 8CSJ, 8CTP, 8CUN, 8CUV, 8CWU, 8YAE.

Canadian: 3DH, 3NI, 3TB, 3ZS, 4CR, 9BW, 9BX.

The following U. S. amateurs were copied in daylight: 3BOF, 4RH, 5HL, 5QL, 5UP, 5WV, 5AIU, 8ALW, 8CWU.

9BJT, STREATOR, ILL. (Det. Only.)
C.W.—1AW, 1KV, 1CAU, 1ARF, 1BBO, 1BCG, 1CDM, 1CKP, 1ZE, 2FP, 2AFP, 2AGB, 3HE, 3HV, 3SU, 3ZO, 3ATG, 3BFU, 3BVA, 3BVU, 4AT, 4BO, 4CS, 4DN, 4DX, 4GX, 4GZ, 5EK, 5GP, 5HL, 5IN, 5NN, 5NS, 5RE, 5VA, 5ADO, 5AEC, 5AGJ, 5AHD, 5AKW, 5AMA, 5ZAS, 5ZAV, 6CU, 6EA, 6EB, 6EN, 6JD, 6KA, 6TV, 6ZW, 6ZZ, 6ALV, 6ARB, 6ARU, 6AVV, 6AWT, 6BIO, 6BVG, 6CBU, 6XAD, 6XBC, 7BX, 7BJ, 7LU, 7SC, 7ZD, 7ZU, 7ZV, 8PK, 20M, 5BW, 8BDA, 9CEN, Canadians—All C.W.:—3AN, 3BP, 3DS, 3NI, 3XN.

2BIR—NUTLEY, N. J.
(1AAC), 1ABS, (1ACB), (1ACU), 1ADN, (1AFP), (1AIG), 1AJP, 1ALJ, 1AMF, (1ANR), 1AOM, 1AQU, 1ARF, (1AUR), 1AVK, (1AYZ), 1BBO, 1BBP, (1BES), 1BGC, 1BSJ, 1BVH, 1BVR, (1VB), 1CDM, (1CKP), 1CMP, 1CMX, 1CP, (1CQL), (1CRW), 1CTW, 1AW, (1D), 1EE, 1ER, (1ES), 1IL, 1KX, 1ON, 1RH, (1RR),

ILLINOIS CUSHION-RESILIENT SOCKET

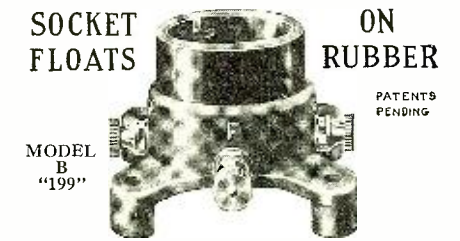
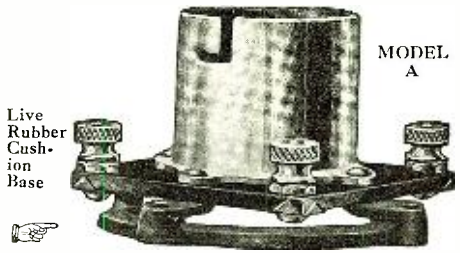

This final improvement in Vacuum Tube Sockets is to protect Tubes from mechanical vibrations and shocks, which cause distortions and many of the noises in phones, especially when amplified. Furthermore, a sudden jar or shock has caused the parting of many an incandescent filament.
Model A for Standard Base Tubes, \$1.25; Model B for Small Base Tubes UV-199, \$1.00 postpaid. Send checks or money orders.

DEALERS—Write for circular and discounts.
ILLINOIS RADIO CO., Springfield, Illinois

LIGHTNING!
Will It Hit Your Aerial Next?
Protect Your Radio, Your Home, Your Life.

What if lightning hits your aerial, or a wind or sleet storm brings your aerial into contact with a power-light circuit? FIRE! Not only destruction of your radio, but FIRE!

Approved by Fire Underwriters
Only Cook Protectors give absolute protection. Approved by National Board of Underwriters. Both types made in dark brown porcelain with accurate air gap dischargers. The R-73 has, in addition, a fuse to protect receiving set from low potential currents and knife cut-out switch — being the acme of protection.
Ask your Dealer first or send money to
Cook Electric Company
2700 Southport Ave., Chicago, Ill.
Sent postpaid in U. S. A.

Vacuum Tubes Repaired

WD-11, WD-12, UV-201A, UV-199 and others for
\$3.00
Quick service. All tubes repaired by us guaranteed to work as good as new. Send your dead tubes. We prepay parcel post to you. All you pay is \$3.00 to postman. We give 48 hour service.
THOMAS BROWN CO.
511-517 Orange Street N. Y. N. J.
Radio Dealers—Write For Our Proposition

1SK, 1UJ, 1XP, 1ZF, (2CNP), (2CPH), 3ACY, 3ADN, 3AHT, 3AIS, (3AJG), 3APT, 3AKR, 3AUV, 3AWG, 3AWL, (3BBV), (3BCD), 3BDO, 3BEU, 3BHV, 3BIF, 3BLC, 3BML, 3BOF, (3BOP), 3BRF, 3BUC, (3BVA), 3BVL, 2CDK, 3CDX, (3CDU), (3CEG), 3CFV, 3CCU, 3CHF, 3CHG, 3CHI, 3CHU, 3CMF, 3AB, (3CC), 3JJ, (3IID), 3ME, 3RF, 3SU, 3TF, 3TR, (3VK), (3WF), (3WO), 3ZM, (3ZO), 4BX, 4BY, (4CS), 4DB, 4DN, (4EB), 4EP, 4FA, 4FT, 4GL, 4GX, 4HZ, 4KB, 4KC, 4KU, (4LJ), 4MB, 4OF, 5AAB, 5AGJ, 5AMH, 5EK, 5GA, 5GM, 5GP, 5MN, 5OF, VA, 5AAJ, 5ABE, 5ABM, 5ADG, 5ADH, 5AGW, 5AHR, 5AJE, 5AMD, 5AMP, 5AMZ, 5APT, 5APV, 5AOC, 5AED, 5ATN, 5AVN, 5AWP, 5AXN, 5AZO, 5BL, 5BCT, (5BDA), 5BDH, 5BDU, 5BAH, 5BFH, (5BGE), 5BGL, 5BIZ, (5BIS), 5BJV, 5BLC, (5BNO), 5BOE, (5BOY), 5BTM, (5BUV) 5C3I, 5CCR, 5CDI, 5CEI, 5CFJ, 5CGX, 5CJD, 5CJP, (5CKN), 5CKO, (5CMT), 5CMU, (5CNR), 5CNW, 5CNS, 5CUC, (5CUE), 5CXN, 5CZO, 5DBL, 5DCZ, (5DGE), 5DGR, 5DHA, 5DID, 5DKM, 5DKI, 5DDN, (5AB), 5AL, 5AO, 5DH, 5GG, 5GZ, 5HJ, 5HN, 5II, (5KO), (5KR), (5KU), (5LJ), (5LT), (5NB), 5OE, 5OK, 5PL, (5RJ), (5SF), 5SB, 5TX, 5UE, 5UP, (5VO), 5VY, 5VY, (5ZC), 5ZD, 5ZZ, 5ZAE, 5AAL, 5AAU, 5AAW, 5AIC, 5AIM, (5AII), (5ALB), 5ALX, 5APS, 5ARC, 5ARD, 5AUS, 5AUY, 5AVG, 5AVJ, 5AWG, (5AWK), 5AXX, (5AZX), 5BDB, 5BDH, (5BMU), 5BPV, 5BRO, 5BRK, 5BTD, 5BTT, 5BVP, 5BVC, 5BWF, 5BXC, 5CEE, 5CFK, 5CFO, 5CGT, 5CGU, 5CHE, 5CIP, 5CPB, 5CTG, 5CVS, 5CXH, (5DRE), 5DHP, 5DIS, 5DIX, 5DQE, 5DRO, 5DYL, 5DYN, 5DZI, 5DZY, 5EPB, 5EJA, 5ELB, 5ELD, 5EXF, 5BE, 5IG, 5MM, 5OR, (5UC), 5VR, 5ZT, 5ZY, Canadians:—1AR, (2BE), 2CG, 3ADN, 3BP, 3BO, 3CO, 3DS, 3GE, 3HE, 3IA, (3OH), (3OD), (3TR), 3XN, Anyone hearing my 50-watt C.W. PSE QSL via CRD.

5LG (NOW AT STATE COLLEGE, N. M.)
 4 FT, (5 ADB), (5ADO), 5AE, 5AEC, (5AGE), 5AHD, 5AHT, 5AIF, 5AIU, (5AJJ), (5AKN), 5AKZ, 5AKZ, 5ALJ, 5AMA, 5AMW, 5BE, 5EN, 5FA, 5FC, 5GA, (5GE), 5GJ, 5GN, (5HZ), 5IO, 5IY, (5JC), (5JF), 5KC, (5KG), (5KW), 5MA, 5MC, (5MM), 5MN, 5NJ, 5NN, 5NS, 5NZ, 5PB, 5PH, 5OL, 5OO, 5SK, (5TM), 5UJ, 5UO, 5VA, 5VF, 5VO, (5VY), 5ZAF, 5ZAV, 5ZM, 6AFP, 6AHU, (6AJD), 6ALD, 6ALV, (6AOU), 6APP, 6APW, (6ARB), (NARU), 6AUI, (6AVR), 6AWT, (6BAH), (5BAJ), 6BCL, 6BJK, (6BJO), 6BIY, 6BKS, 6BMG, (6BPZ), (6HOC), 6BRF, (6BUO), 6BUY, (6BVG), 6BWP, 6CBU, (6CFI), (6CFZ), (5CGD), 6CGW, 6CKR, 6CMR, 6CNH, 6JX, 6GR, (6HV), 6KA, (6OD), (6PL), (6RM), (6TU), (6TV), 7AGV, 7BJ, 7IC, 7LN, 7WM, 7ZF, (7ZN), 7ZV, 8BDU, 8IJ, 8VY, 9AAU, 9AIM, (9AMB), 9AVZ, (9BEZ), 9BFP, 9BJK, 9BSH, 9EUN, 9BVO, 9BXL, 9BXO, 9CAA, 9CAJ, 9CCS, 9CCV, 9CVC, 9EAE, 9EJH, 9EKY, 9ZT, Wud appreciate a QSL on my 10 watt CW. All crds answered. QSL to A. K. Tatum, State College, N. M.

CAN. 3AEL, KINSTON, ONT.
 1BCG, 1CMP, 1CCZ, 1BRO, 1CDK, 1ACU, 1AYZ, 1AYM, 1BTK, 1AIG, 1AJJ, 1CMD, 1VU, 1AW, 1BUB, 1AO, 1CKP, 1RR, 1BKQ, 1CBC, 1AAC, 1CG, 2ANA, 2CVD, 2BUM, 2AWH, 2BMA, 2AWL, 2AR, 2BNZ, 2EL, 2VH, 2BB, 2CEI, 2PD, 2BN, 2SO, 2BOI, 2ABU, 2AGP, 2AFP, 2UJ, 2BFZ, 2LE, 2BO, 2CG, 2BYC, 2CU, 2BKC, 2AQB, 2CUI, 2RM, 2BS, 2CCU, 2FZ, 2KI, 2AW, 2CDX, 3OJ, 3RC, 3CDK, 3BIE, 3TR, 3ZM, 3BEI, 3CO, 3IS, 3ADB, 3APT, 3IJ, 3NI, 3EL, 3OF, 3ES, 3NR, 3AEE, 3BPU, 3HH, 5DX, 5MN, 5GP, 5AER, 5EB, 5EO, 8BXZ, 8AYY, 8TB, 8BXH, 8IY, 8SE, 8CTY, 8ZUV, 8IJ, 8RO, 8ABM, 8AWP, 8COY, 8RF, 8TJ, 8UT, 8AIO, 8DJO, 8BUM, 8ABN, 8HT, 8CU, 8PL, 8BLX, 8BV, 8KA, 8COI, 9DXE, 9AP, 9ARC, 9DG, 9ZT, 9AFP, 9AUS, 9AMU, 9QA, 9BRM, 9DED, 9CVN, 9DRO, 9UC, 9BW, 9APS, 9ANX, 9AAU, 9MM.
 Phone—2RB.
 Spark—20M.
 Canadian—(3HE), (3AAY), (3OQ), 3OH.
 Will gladly QSL all reports.

8BAA, BATTLE CREEK, MICH. (ONE TUBE)
 C. W.—1ANA, 1AJJ, 1ACU, 1AYZ, 1AFP, 1BCG, 1BKQ, 1BCA, 1BSJ, 1BRO, 1BES, 1CDM, 1CCZ, 1CPO, 1CKP, 1CVA, 1CMP, 1ER, 1EN, 1FB, 1GV, 1JO, 1OW, 1UJ, 1XP, 1ZE, 2ANA, 2AFP, 2AWH, 2AJW, 2ADB, 2AGR, 2BR, 2BRB, 2BEM, 2BPE, 2BN, 2BME, 2CJP, 2CRH, 2CLJ, 2CTO, 2COW, 2COZ, 2CRT, 2CIM, 2CVJ, 2CBC, 2CJR, 2EL, 2FP, 2IF, 2IF, 2LV, 2LG, 2ABG, 2AMJ, 2AD, 2AWH, 2AHP, 2AHR, 2BNU, 2BUC, 2BRE, 2BDO, 2BVL, 2BBV, 2BML, 2EP, 2CFV, 2CCU, 2CAN, 2CRF, 2HH, 2IN, 2IW, 2IF, 2IJ, 2KM, 2LK, 2OI, 2VO, 2ZO, 2BY, 2CS, 2DO, 2DT, 2EL, 2FA, 2GX, 2GL, 2GW, 2IT, 2KU, 2LJ, 2XV, 2OF, 2ABY, 2ABT, 2AGJ, 2AKN, 2AJJ, 2ACM, 2AMA, 2AIV, 2AC, 2DS, 2FV, 2GP, 2GA, 2GM, 2GW, 2HL, 2HE, 2LL, 2MM, 2NT, 2PH, 2OO, 2RL, 2UK, 2WG, 2XV, 2ZAV, 2ZK, 2GV, 2IX, 2CBU, 2ZU, 2AAB, 2ABX, 2AEG, 2AIO, 2AL, 2AID, (FN), 2ACP, 2ANP, 2AO, 2APT, 2ARP, 2ATC, 2ARX, 2AHO, 2AVL, 2AWP, 2AZH, 2BD, 2BDU, 2BIZ, 2BLW, 2BNO, 2BVT, 2BCP, 2BCI, 2BZC, 2BFH, 2BXX, 2BVV, 2BZO, 2BJV, 2BLX, 2BHY, 2CKE, 2CP, 2CUV, 2CAL, 2CRD, 2CJZ, 2CYZ, 2CKN, 2CZZ, 2CSJ, 2CYX, 2CKO, 2CSV, 2CNR, 2CXM,

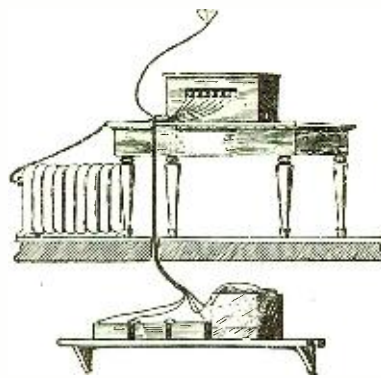

(Pat. Applied For)

batteries, etc., connected to the cable and plug. Thus several sets can be tested one right after the other and instant connection made.

Dealers can connect several Binding Post Sockets to various models and use one set of batteries, etc. A simple quick connection can be made and the prospect given demonstration of several sets, without disconnecting and reconnecting batteries, etc., to the Binding Posts of each set.



(Pat. Applied For)

In house use, batteries can be placed in cellar and small hole drilled through floor for cable—the length and size of wire is designed so no efficiency in current is lost.

Plug and socket are so constructed they will not fit except in proper positions. Manufacturers will find this a big selling help. This plug and socket (panel mounting) has been adopted as standard equipment by several leading set manufacturers.

PRICES

Panel Mounting Type	\$4.00
(Templet for drilling panel furnished)	
Binding Post Type	5.00
Extra Binding Post Ends for set, each	1.80
Extra Panel Mountings, each80

Write for illustrated folder.

Condenser Cleaner

From your dealer10c.
 Postpaid from us12c

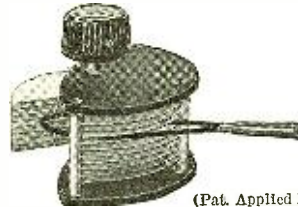

(Pat. Applied For)

It gets between the plates and cleans, without bending the plates. 24 on a card.

Fiddle Stick

From your dealer10c.
 Postpaid from us12c.



(Pat. Applied For)

The vernier tuning that eliminates body capacity. 24 on a card.

HOWARD B. JONES

612 So. Canal St., Chicago



The BATES EAR CUSHION

No finer Christmas gift for radio fans. Supreme comfort and keener hearing. Slips over any radio phone. Postpaid anywhere in U. S.\$1.00
 DEALERS: Write for special discounts. Fastest moving radio accessory on the market.

BATES & COMPANY,

1520 Montana St., Chicago, U. S. A.

Why Pay More?

GENUINE R.C.A. TUBES

W.D. 11 \$5.95 UV-199
 W.D. 12 UV-201A

ALL NEW, NO STAMPS, NO C.O.D.

BALDWIN PHONES \$9.75

Send for our New Price List with many other items.

Save Money By Buying From Us

CUT RATE RADIO CO.

P. O. Box 472 Newark, N. J.

Insure your copy reaching you each month. Subscribe to Radio News—\$2.50 a year. Experimenter Publishing Co., 53 Park Place, N. Y. C.

Another Radio Achievement

"For the Grid of Your Tube" Use

GREWOL VARI-GRID



An exceedingly small enclosed vernier variable condenser, taking up but 1 3/4" on your panel and absolutely replacing all 11 and 23 plate condensers!

Two articles for less than the price of one. The Grewol Vari Grid is especially adapted for use as a variable grid condenser being equipped with a variable grid leak which can be removed if desired.

Every set needs at least one. You'll get a 100% improvement in distance and reception by using the Grewol vari-grid in your grid circuit. Try one in the aerial circuit too and across the secondary. They work wherever ordinary condensers are used. And they have a vernier adjustment.

You've plenty of room for two on your present set. They take up so little room, only one hole to drill.

Write for Booklet.

RANDEL WIRELESS CO.

11 Central Ave., Newark, N. J.

At
Your
Dealer's

or sent Direct upon Receipt of **\$ 2²⁵**

The Peak of Radio Perfection

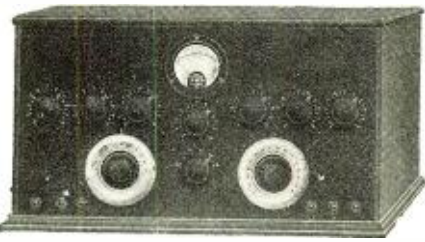

Price \$175

Type LR-70, 3 Stages Radio, Detector.
3 Stage Audio Frequency Amplification.



Pat. Pend.
Type LT-11, \$35.00

The Secret is in the Patented Winding

The LOOP TUNER and the Nassau Broadcast Receiver

TRADE MARK

Eliminates Aerial and Ground with Clearer Reception. EXTREME SELECTIVITY with easy manipulation. FLEXIBILITY—4 to 7 tubes may be used at will. RANGE—DX stations on the Loud Speaker. SPECIAL WESTON VOLTMETER—Showing A and B Battery voltages. Contains all batteries for dry cell operation. Write for Circular "R."

NASSAU RADIO COMPANY, Inc.

60 Court Street Brooklyn, N. Y., U. S. A.

We Repair The Following Radio Tubes

WD-11\$3.50	UV-199\$3.50
WD-12 3.50	C-299 3.50
UV-200 2.75	UV-201A 3.50
UV-201 3.00	C-301A 3.50
C-300 2.75	UV-202 4.00
C-301 3.00	C-302 4.00
DV-6 3.00	DV-6A 3.50

Dealers & Agents write for Special Discount
Mail Orders solicited and promptly attended to.

H. & H. RADIO CO.

P. O. BOX 22-H
Clinton Hill Sta. Newark, N. J.

Sunset REFLEX Crystals Guaranteed

Hook one up to your reflex circuit—note the stations you've never heard before—how clear and loud. Sunset is a new and superior galena, mounted in woods metal. Buy a Sunset Reflex Crystal today Tune in to 50c DX tonight.

Granular Galena in Bulk for Sale.
Mfrs., Dealers, Jobbers: Write for our Proposition.

U. S. MFG. & DIST. CO.,

45 Clinton St., Newark, N. J.

SCKV, 8CUR, 8CRE, 8CPP*, 8CTN, 8CYO, 8CDD*, 8DJF, 8DKM, 8DLA, 8DKI, 8DAI*, 8DCC, 8ES, 8FM, 8FT, 8GZ, 8HV, 8IJ*, 8KO, 8KU, 8KG(in), 8KR, 8NB, 8OK, 8RJ, 8SP, 8TC, 8VN, 8VO, 8VY, 8XAD(in), 8ZZ, 8ZD, 8ZT, 8ZR, 8ZW, 9AAL, 9AAW, 9ACU, 9AGA, 9AGN, 9AHJ, 9AHZ, 9AJH, 9AMI, 9ANP, 9AOU, 9APE, 9APS, 9AQQ, 9ARP, 9ARW, 9ARZ, 9ASV, 9AUD, 9AVA, 9AVP, 9AVY, 9AWG, 9AWK, 9AXX, 9AYL, 9AZX, 9BAF, 9BAK, 9BAZ, 9BBO, 9BBO, 9BCK, 9BDS, 9BEH, 9BFD, 9BFI, 9BHD, 9BHI, 9BIS, 9BKI, 9BKJ, 9BKK, 9BKO, 9BLG, 9BMU, 9BNB, 9BQC, 9BRU, 9BRX, 9BT, 9BW, 9BYZ, 9BZI, 9CAA, 9CAH, 9CAU, 9CC, 9CCF, 9CDV, 9CE, 9CFY, 9CGA, 9CGT, 9CGU, 9CHE, 9CIL, 9CIP, 9CJS, 9CLN*, 9CME, 9SN, 9CVC, 9CVS, 9CVV, 9CWF, 9CXH, 9CZY, 9DAW, 9DCE, 9DCR, 9DDN, 9DER, 9DFW, 9DGE, 9DGV, 9DHF, 9DHP, 9DHU, 9DMU, 9DOE, 9DO, 9DOU, 9DRI, 9DRO, 9DRR, 9DST, 9DVM, 9DWA, 9DXY, 9DZY, 9EAB, 9EBG, 9ECY, 9EDO, 9EFZ, 9EG, 9EHJ, 9EI, 9EFK, 9EKY, 9ELB, 9ELD, 9HK*, 9IC, 9LD, 9MC, 9DMF, 9MM, 9NU, 9OF, 9PJ, 9PB, 9TV, 9TK, 9UG, 9VK, 9VM, 9ZY, 9ZT.

Spark—2BR, 2BK, 5BW, 8RQ, 8BCO, 9AOJ, 9D(), 9LF.

Canadian—2BE, 2BN, 2CG, 3CO, 3DS, 3KG, 3OH, 3OI, 3JK, WL, QSL, ANI, CRDS, FM, ABOVE, STNS.

ARE YOU BEING HEARD IN HAWAII?

Editor, RADIO NEWS:
The following calls were heard at Radio KHL on the evenings of July 20th, 21st and 22nd, inclusive:

4NK, 5TE, 5AOL, 6AL, 6AO, 6ANK, 6AOF, 6ASR, 6ASV, 6AV, 6BGR, 6BJQ, 6BQC, 6BR, 6BRF, 6CEU, 6CCK, 6CFZ, 6CHL, 6CKP, 6CMA, 6CMC, 6CMH, 6CMU, 6CT, 6CMR, 6DPR, 6FH, 6GH, 6GR, 6GX, 6JX, 6RX, 6TO, 6UF, 7ABR, 7AGV, 7AIM, 7ANC, 7ARV, 7BG, 7CJ, 7GO, 7GP, 7IW, 7IY, 7OH, 7TG, 7ZN, 9AIM, 9BJK, 9CCA.

Would appreciate QSL's by cards from those whose calls are listed above.

M. J. BROWN,
MAUI TELEPHONE Co.,
Wailuku, Maui, T. H.

DIED

VT-2—W.E., Brother of R.C.A. UV-202 on August 22, at the residence of his employer, 2AAK, in his first year while performing work of a mightier tube. Funeral from his late residence the G.R. socket, on Sat., August 25, at 2 P. M., thence to W.E. carton. Interment private.

By 2AAK.

QRA Reports

NOTICE

Roy A. Anderson has left Ketchikan, Alaska, and is not, for the present, operating. His old call (7JT) has been reissued.

3BEZ

The call 3BEZ has been assigned to Raymond L. Luckett, 1212 Orsen Street, N. E., Washington, D. C.

9ELI

The call 9ELI has been issued to Kermit Tracy, 2429 Banks Street, Superior, Wis. Will QSL all cards.

9ELT

9ELT has been issued to Leland Gibson, P. O. Box 8, White Water, Kan. Using 5-watt C. W.

1BIP

The call 1BIP has been re-issued to Hartwell Hughes, 5 Underwood Street, Worcester, Mass.

5ANJ

QRA—5ANJ; Gilbert R. Bushing, 3167 N. 6th Street, Fort Smith, Arkansas. 10 watts C.W.

8BRB

8BRB; Lawrence K. Garland, 304 S. 4th Street, Apollo, Pa. 5 watts C.W.

8CCI

QRA—8CCI; James C. Lisk, 902 S. Elizabeth Street, Lima, Ohio. All crds answd.

7DH

Dr. S. G. Van Slyke (7DH) is now located at Shickley, Nebraska.

2AQR

The call 2AQR has been re-assigned to Ralph Ray, 8 Overlook Place, Newburgh, N. Y. 10 watts C.W.

8BHN

8BHN has been re-assigned to Don Canady, 3439 W. 119th Street, Cleveland, Ohio.

CHARLESTON RADIO CLUB

Organized in November of last year, the Charleston Radio Club has grown to be a power in this city in matters pertaining to radio. The operators of the local broadcasting stations have put their stations under the orders of the club and operate on schedules convenient to the club members. The local dealers co-operate with us in all matters to our mutual advantage. The District Communication officer of the Sixth Naval District, and the officer in charge of the Radio Station "NAO" are both ardent supporters of the activities of the club and assist us in every way possible to get better results from our receiving sets. So far do they carry this interest that at the last meeting of the club both of them came and delivered talks to the club concerning the transmission and reception of messages at the local yard and extended a hearty invitation to visit the station and see how the traffic was handled. And let me say here that when a station like NAO is only about five miles airline from the city it pays to make friends with the powers that be, and secure their support and co-operation, as we have done. There are some who may say that there ain't no such animal with the navy, but they are all wrong. We'll say they are! If as individuals nothing can be done, organize and treat the other fellows as if they were about to swap places with you, and the trick is done.

We first held our meetings in the Chamber of Commerce, but when they became crowded with activities that demanded room, we accepted the invitation of the Young Men's Board of Trade and changed our quarters to their building where we now meet and where sometime in the near future we hope to install a transmitter for our mutual benefit. This set will be used primarily to inform the outlying districts of the news of the day in which they are particularly interested.

The personnel of the club is made up for the most part of some of the most substantial men of the city. This accounts in part for the splendid success we are enjoying. Our president, M. B. Paine, is an automotive engineer, our vice-president C. G. Planck, is principal of the Industrial High School. Every officer does his duty to the best of his ability which means that he has the whole-hearted assistance of the club members. The writer has the rather difficult position of managing secretary and were it not for the co-operation of the members it would be impossible for him to perform the many duties assigned him.

KENNETH C. PARSONS, Secretary,
Charleston Radio Club,
Charleston, S. C.

AMATEUR RADIO CLUB FORMED IN GERMANY

By DR. A. GRADENWITZ

(Berlin Correspondent of Radio News)

Germany, which so far has known the Radio fan species only from hearsay, at last seems to be willing with great energy to enter the radio amateur movement. Though the monopoly of the Post Department still threatens with severe penalties the man or woman daring to install a receiving set of his or her own, a German Radio Club likely to be mainly composed of offenders against these regulations has recently been founded in Berlin. At the first meeting of this club, Dr. E. Nespei, in a short address drew attention to what is being done abroad in the way of broadcasting, at the sending as well as at the receiving end, after which he went on to discuss the possibility of a German organization avoiding any prejudice to the State's radio service. While the Postal Department contemplates leasing ready-made receiving sets, the amateur cannot possibly be content with a station he is unable himself to fit up and alter in accordance with his own ideas.

Dr. S. Loewe, in the following lecture,



Charges Radio and Auto Batteries at Home Over Night - For a Nickel!

For a friend who owns a radio set or automobile, what could be more appropriate than a gift which would eliminate the inconvenience and expense of taking his battery to a service station every time it requires recharging? The

GOLD SEAL HOMCHARGER
The World's Most Popular Battery Charger

is such a gift, appropriately dressed up in a beautiful Christmas package, too. It charges any AUTO, RADIO or "B" storage battery in the simplest, quickest and most efficient manner possible. Connects to any lamp socket—operates silently—requires no watching. Fully automatic in operation—absolutely safe.

HOMCHARGER'S TEN POINTS OF SUPERIORITY

1. **Simple**—Only one moving and wearing part, replaceable after thousands of hours use for \$1.00. Will last a lifetime.
2. **Efficient**—Uses less than one-half the current of any bulb or liquid type rectifier. Will charge any radio or automobile battery for a nickel.
3. **Quick**—Its high charging rate of 7 amperes eliminates long waiting for battery to become charged. Will charge any "A" or "B" battery over night, or three times as fast as a 2-ampere machine.
4. **Clean**—No expensive bulbs to break or acids to spill or replace. No acid fumes. Charges without muss, fuss or bother.
5. **Dependable**—Tungsten contacts insure continuous operation—prevent sticking and stopping.
6. **Fool-Proof**—Can be operated by anyone. Attach to lamp socket and connect battery either way, it will always charge. High-grade ammeter eliminates guess work.
7. **Safe**—No danger of shock or fire. Tested and approved by Fire Insurance Underwriters everywhere. Gives tapering charge—will not overheat or injure battery.
8. **Beautiful**—Mahogany and Gold Finish.
9. **Unqualifiedly Guaranteed.**
10. **Popularly Priced**—Retail at \$18.50 complete (\$25.00 Canada). No extras to buy. Sold by all dealers.

FREE BROADCASTING LIST. Ask your dealer or write direct for Free Homcharger List of Broadcasting Stations, and Circular Describing the Gold Seal Homcharger.

DEALERS! JOBBERS!

GOLD SEAL HOMCHARGERS in their attractive Xmas packages are going to be "best sellers" to the holiday trade. Write for our elaborate merchandising plans and then prepare to get your share of this big "Homcharger Xmas business".

Insist on the GOLD SEAL

ACCEPT NO SUBSTITUTE. Like all good products, the HOMCHARGER has been widely imitated. No other charger is just as good. INSIST on seeing our registered trade-mark, the "GOLD SEAL," on nameplate and carton before purchasing.



The Automatic Electrical Devices Co., 118 West Third St., Cincinnati, O.

Largest Manufacturers of Vibrating Rectifiers in the World

One Thousand Agents Wanted

WE want one thousand agents to sell subscriptions to RADIO NEWS, SCIENCE AND INVENTION and PRACTICAL ELECTRICS. We will pay a generous commission for this work and help you in every way. Our three publications are leaders in their fields, ready sellers and this is an offer well worth your while. A few spare hours a day will bring you a handsome return. Write regarding our proposition at once and be the first one to get started in your vicinity.

EXPERIMENTER PUBLISHING CO.,

HERBERT H. FOSTER, Sales Manager

53 Park Place

New York

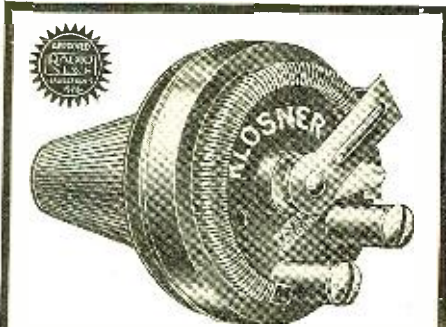

**YOUR
Detector Tube
Still Needs a
VERNIER RHEOSTAT
for best results.**

Why take chances with an untried product when you can get the original Vernier—the Klosner—for \$1.50, fully equipped with the most attractive Condensite dial and base plus the high standard of workmanship which made this new and improved design so popular.

30 Ohm style for the new tubes\$1.75

Most uptodate dealers have Klosner's but if you cannot get them, send your order direct mentioning your dealer's name.

Request free interesting literature

Klosner Improved Apparatus Co.

2024 Boston Road New York City



**FREE
VACUUM TUBE
RADIO SET**

Can receive 100 miles and more.

RUSH your name to learn how you can get a Vacuum Tube Radio Set ABSOLUTELY FREE

Don't delay, write today for FREE RADIO PLAN.

HOME SUPPLY CO.
Dept. 17
131 Duane St., N.Y.C.

TELEGRAPHY

BOTH MORSE AND WIRELESS taught thoroughly. Big salaries; tremendous demand. Oldest, largest school. Endorsed by Telegraph, Railway, Wireless and Government officials. Expenses low—no transportation to even large territory. Catalog Free.

DODGE'S INSTITUTE, Mora Street, Valparaiso, Ind.

showed to what enormous and ever-increasing extent other countries were profiting by radio accessible to amateurs and what important parts some leading persons were playing in this connection. During the lively general discussion then ensuing, an earnest wish to both secure a radio amateur service in Germany and to baffle the monopolizing tendencies of individual firms or groups of firms was expressed by those present.

In the course of further meetings, both the statutes of the Club and such measures of precaution as, until further notice, are required in connection with an as yet illegitimate broadcasting service, were discussed. The technical side of the art was likewise dealt with, and the general feeling was that suggestions given by amateurs were likely in many cases to prove fertile for the development of radio engineering.

At the last meeting, to which the writer was invited, Mr. Platz gave an instructive historical account of the development of radio, dwelling at some length on the merits of those experimenters whose work made the construction of small receiving stations possible. A diminutive loop antenna presented by the speaker enabled the productions of the London Grand Opera to be received. The end to be attained in Germany was to make radio as popular as it is abroad, thus enabling its educational possibilities to be taken advantage of, especially with a view to the spreading of knowledge in engineering. A training course of amateurs, consisting of five experimental lectures, was commenced by Mr. Riepka who, to begin with, dealt with the fundamental principles of the art.

It is intended to issue a high-class magazine *Der Radio-Amateur*.

BUREAU OF STANDARDS TO TRANSMIT RADIO FREQUENCY SIGNALS

The Department of Commerce just announced the schedule of standard frequency radio signals to be transmitted by the Bureau of Standards for the months of October, November and December. These signals should be of interest to all transmitting station operators in checking wavemeters and adjusting transmitting and receiving apparatus. Their accuracy is better than three-tenths of 1 per cent.

Commercial and ship operators should be especially interested in the transmission of October 20. The signals of November 20 cover approximately the same band as those of October 20. The signals of November 5 cover the frequency band used by "Class B" broadcasting stations. The frequencies transmitted on December 5 cover those used by all broadcasting stations as well as some used by amateurs.

Measurements made at the Bureau of the frequencies on which broadcasting stations are operated indicate that some stations are not remaining on their assigned frequencies, and hence are causing interference with programs from their own as well as other broadcasting stations.

The schedule followed in these transmissions will be slightly different from that followed in the past. All transmissions will be by unmodulated continuous wave telegraphy and no announcement will be made by voice. This considerably reduces the time of transmitting any one frequency. The signals will in other respects be similar to those transmitted in the past. A complete frequency transmission will include a "general call," a "standard frequency signal," and "announcements." The "general call" will be given at the beginning of the eight-minute period and will continue for about two minutes. This will include a statement of the frequency. The "standard frequency signal" will be a series of very long dashes with the call letters WWV intervening. This signal will continue for about four minutes.



RADIO ACCESSORIES

MICA CONDENSERS

Mica Condensers of all capacities. TESTED and GUARANTEED accurate to rated capacity. List price25c

GALENA I there were any
PYRITES F better we would
SILICON F make them.

Tested and Guaranteed

Packed in cotton in individual boxes.
List Price10c

Paper Condensers, Mounted Crystals, Binding Posts, Switch Levers, Detectors, Sliders, Contact Points, Aluminum Sockets

VARIABLE GRID LEAK

Variable Grid Leak. 0-10 Meg. Specially formed tension contact. Permanent, impregnated Grid Line—with Composition, tapered knob. List price25c

This Grid Leak recommended by the Editor of the Sun-Globe Data Sheets of August 18th, 1923.

**WHOLESALE ONLY
WRITE TO-DAY FOR TRADE DISCOUNTS.
FORMAN & CO.**

Manufacturers
366 Greenwich Street, New York

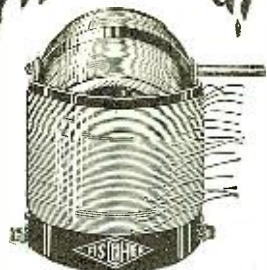

*Approved by Radio Experts for
Radio Amateurs*

Approved because:—

Wave length is 550 Meters; 16 soldered leads; straight wound stator on genuine bakelite tubing; kiln dried rotor; Fahnestock spring clip connections; non-conductive adhesive; You can

GET ONE FOR \$3.50

20 DIAGRAMS FREE WITH EACH

For Sale at your Dealer's
—otherwise send the \$3.50 directly to the manufacturer and you will be supplied postpaid.

G. H. Fischer & Co.

123 Liberty Street, New York City

Radio Savings

ALL RADIO PARTS AT GREATLY
REDUCED PRICES

	List Price	Our Price
5000 Ohm Murdock Headset\$7.50	\$3.50
Nathaniel Baldwin Type "C" Headset12.00	8.50
Nathaniel Baldwin Type "O" single unit6.00	4.25
13 Plate Signal Condenser, Bakelite Ends1.75	
23 Plate Signal Condenser, Bakelite Ends1.50	
Magnus Sockets, wipe Contact1.00	.65
Bakelite Tubing: 3" or 3½"—13c; 4"—20c per lineal in. cut to your order.		
Bakelite Panel: 3/16"—2c; ¼"—1½c Per square inch.		

MAIL ORDERS FILLED SAME DAY RECEIVED

CONRAD RICHTER

1286 Market St., San Francisco, Calif.

The "announcements" will be on the same frequency as the "standard frequency signal" just transmitted, and will contain a statement of the measured frequency. An announcement of the next frequency to be transmitted will then be given. There will then be a four-minute interval while the transmitting set is adjusted for the next frequency.

The complete schedule has been so planned that a wavemeter may be accurately calibrated over a range from 150 to 1,700 kilocycles, if all of the transmissions are received. With sensitive receiving apparatus it should be possible to receive these signals anywhere east of the Mississippi River.

Detailed information for the use of these signals is given in Bureau of Standards Circular Letter No. 92, which may be obtained upon application to that Bureau.

The complete schedule of standard frequency signals to be transmitted follows:

SCHEDULE OF STANDARD FREQUENCY TRANSMISSION FROM WWV

Eastern Standard Time	Oct. 20	Nov. 5	Nov. 20	Dec. 5
11:00 to 11:08 P. M.	166.5 (1800)*	500 (600)	150 (1999)	500 (600)
11:12 to 11:20 P. M.	220 (1363)	580 (317)	190 (1578)	700 (438)
11:24 to 11:32 P. M.	275 (1090)	640 (468)	240 (1249)	900 (333)
11:36 to 11:44 P. M.	315 (952)	700 (428)	290 (1034)	1100 (273)
11:48 to 11:56 P. M.	375 (800)	760 (394)	360 (833)	1300 (231)
12:00 to 12:08 A. M.	425 (705)	833 (360)	430 (697)	1500 (200)
12:12 to 12:20 A. M.	500 (600)	920 (326)	500 (600)	1600 (187)
12:24 to 12:32 A. M.	666 (450)	1000 (300)	570 (526)	1700 (176)

*Wave-length in meters is given in parentheses.

NOTICE

5XV is broadcasting tests and bulletins on 125 meters so that receivers can be calibrated by that sure signal. 5XV will be glad to arrange tests with anyone who so desires.

Some Practical R. F. Notes for Operating Amateurs

By A. REISNER

EVERY amateur in the course of his experimenting comes across pointers which are of use at later times. Some of these may be of use to other experimenters and it ought to be a practice of amateurs to note these pointers down and publish them for the benefit of the rest of the gang. The writer gives some notes which he has recorded and which have proved useful.

USING SERIES CONDENSERS

In receiving outfits there is no particular disadvantage in using condensers in series, although it might be better to use one instead of two, as increasing the number of units may increase the losses. In transmitters, however, there is a decided disadvantage. If one of the series condensers is very much lower than the other in capacity there will be an unbalancing of voltages across the condensers which may harm the smaller capacity. This is due to the fact that the voltage across the condenser is inversely proportional to the capacity. Thus, if the series condenser is 1/2 the other condenser, it will have to withstand twice the voltage of the other. The total voltage distributes itself across the condensers inversely as the capacity. Thus in the above case the total circuit voltage is divided as follows: 1/3 for the regular condenser, 2/3 for the series condenser. Condenser breakdowns have been traced to this cause. In transmitters the addition of series condensers may add considerably to the resistance of the circuit and

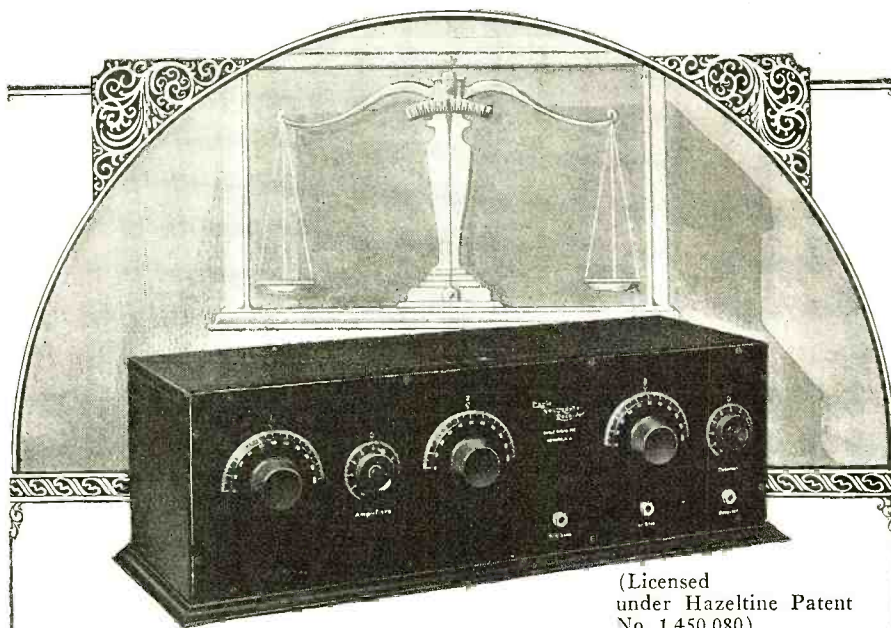

(Licensed under Hazeltine Patent No. 1,450,080)

THE cherished ideal of radio scientists—reception without limitations, yet simple to use as a telephone—crystallized in this amazing receiver.

**The Eagle
Balanced-Neutrodyne
RADIO RECEIVER**

Balanced tube capacities, as infinitely scrupulous as the balance of a jeweller's scale, frees this Receiver from regeneration, reradiation, and all body capacity effects. Greater range, crystal-clear reception and easy, positive operation. As fine reception for the novice, as for the most adept, with the *Eagle Bal-*

anced Neutrodyne Receiver. All tuned circuits. Every receiver individually tested and inspected from beginning to completion. *Quality*, not quantity, production in order to sustain a well-respected reputation. Guaranteed without reservations.

Write for
Booklet TODAY



20 Boyden Place,
Newark, N. J.

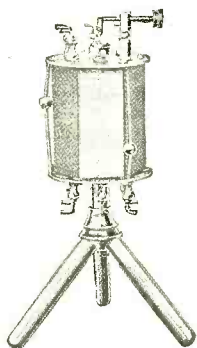

9 Inches High
Beautifully Nickel
Plated

MARTIAN BIG FOUR

The Wonderful High Grade Crystal Radio Receiving Set
SIMPLICITY EFFICIENCY QUALITY

The Martain Sliders (2) for sharp tuning produce clearness and volume

One, two, three or four headsets can be used. One to eight persons can "listen in" at one time.

Tuning Coil is non-shrinkable.

Anyone Can Install and Operate the Big Four
Guaranteed to receive concerts from all broadcasting stations within a radius of 30 miles.

If your dealer cannot supply you, we will send you a Martain Big Four set prepaid anywhere in the United States upon the receipt of Price, \$7.50

JOBBERS and DEALERS — WRITE OR WIRE FOR DISCOUNT SHEET

WHITE MANUFACTURING COMPANY
93-107 Lafayette Street Newark, New Jersey

DUTHO

Rechargeable Storage "B" BATTERIES

Cost You Less
Last Longer



\$5
6" x 2 3/4" x 2 3/4"
Weight 2 1/2 lbs.

DUTHO 'B' Batteries eliminate all battery noise and internal action. This prevents distortion. Heavy, individual glass tubes permit visibility at all times and make surface discharge impossible. You can see when and how to "keep them up." Condensing chamber in each cell overcomes fumes and prevents spillage.



\$9
6" x 2 3/4" x 4 3/4"
Weight 4 1/2 lbs.

DUTHO Batteries are sold DRY CHARGED, with solution in separate container. Once filled your battery is fully charged, ready for immediate use. Ordinary care in following directions will make DUTHO 'B' Batteries last indefinitely. Thousands in use today.

DEALERS: Write for attractive proposition.

DURKEE-THOMAS PRODUCTS CO.
1228 Folsom Street
San Francisco

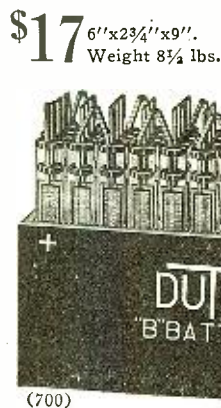

\$17
6" x 2 3/4" x 9"
Weight 8 1/2 lbs.

Chemical Rectifier \$1.95

thus decrease efficiency. It is desirable, therefore, to avoid wherever possible the use of series condensers and to substitute one condenser having the required capacity. Of course, it should be stated that there are times when it is necessary to use two condensers. The point is, where one will do, never use two to reduce capacity; high and excessive voltages and consequent break-downs follow.

USING TWO SPIRALS FOR OSCILLATION TRANSFORMERS

In transmitter circuits two flat copper strip spirals are sometimes used. The writer has noticed that the radiation falls off quite rapidly when the spacing between transformers is reduced. This was found to be due to the nature of the mutual inductance between two flat spirals. In Fig. 1 is drawn the approximate relationship between mutual inductance and the spacing between the spirals. It will be observed that the mutual inductance is very high for the close spacings, but the slope of the inductance curve is extremely steep, showing that small increases in spacing decrease the mutual markedly, hence the rapid decline in current explained above. This style of coupler is now becoming obsolete, and the conductively coupled transformers are being used more and more.

RELATIVE ADVANTAGES OF SMALL AND LARGE ANTENNAE

This consideration depends largely upon whether we regard the subject from the receiving standpoint or from the transmit-

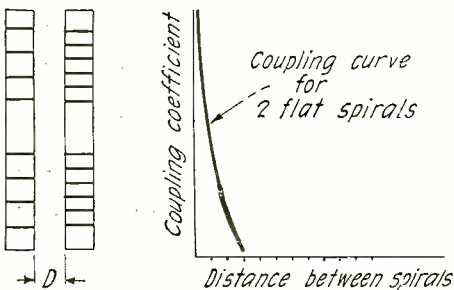

Fig. 1

Coupling Coefficient Curve Plotted Against the Distance Between Spirals.

ting standpoint. From a reception point of view the low and short antenna is as good as the high, because here we are concerned with strays. If the strays are strong as compared with the signal then the so-called static signal ratio is larger and anything which tends to decrease this ratio improves reception. Using a large antenna results in louder signals, but it likewise results in increasing the static intensity, thus the static signal ratio remains very high. On the other hand the use of low antennae, while it results in a decrease in the signal strength, results in a much greater decrease in static intensity, hence the static signal ratio decreases and reception improves. Thus, in certain reception tests on different sizes of antenna, the following static signal ratios were obtained from audibility measurements: Antenna height 150', static signal ratio, 1/2. Antenna height 50', static signal ratio, 1/3. Thus, from a reception point of view, the low antenna is superior to the high, which accounts for the increasing use of low antennae and loops in reception. From the transmitting point of view, however, the results are different because here we are not interested in strays. Strays do not interfere with the transmission of messages, they only interfere with reception. In transmission we are interested in getting as great radiation as possible. This can only be secured by making the radiation resistance of the antenna as large as possible. Among other

(Continued on page 840)

A PERFECT CHRISTMAS GIFT \$7.00

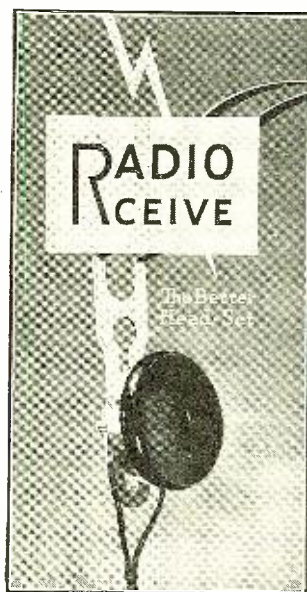

At Your Dealer's or Direct
RADIOCEIVE MFG. CO.
Newark, N. J.

GAMBLING?

You Are If Your Radio Tubes Are Unprotected

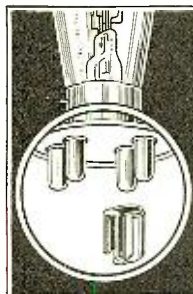

Your Vacuum Tubes are the most delicate parts of your Radio Set.

They are easily blown out—you have probably already had this exasperating experience—it is apt to happen at any time.

"B" Battery wires accidentally crossed for only an instant with the filament leads or sudden excess current from the "A" Battery will do it.

You can prevent this and save yourself money and inconvenience and relieve your mind at a trifling cost.

INSTALL

RADECO SAFETY FUSE

on all your tubes. Applied in an instant to one of the filament terminals. Will fit any standard tube going in any standard socket. Price 50 cents each, sent postpaid and fully guaranteed. Do not delay. Order now. Specify type of tube used.

DEPT. I.

RADIO EQUIPMENT COMPANY

Manufacturers and Distributors of Standard Radio Equipment
630 Washington Street Boston, Mass.
New England's Oldest Exclusive Radio House
Dealers.—Write for our Proposition

W O PERSENSITIVE CIRCUIT

(Both Copyrighted)

My Highly Improved Reinartz brings in all important stations on both coasts and Mexican border, loud, clear and without distortion. We dance to music from Atlanta received on one load Baldwin unit. Build one of these wonderful sets from my blueprints and specifications, price 50c, or with a perfect and complete double wound spidersweb coil, \$3.00 by mail. No other windings used. Photo of my set on a glass panel with every order.

This copyrighted circuit is the most successful of any Reinartz modification yet produced, and is imitated the most. Thousands are in use.

My W. D. II Circuit is especially designed for use with the "Pickie" tube and brings out the full value of that little tube as no other circuit can. Stations 3000 miles away come in clearly on one tube. This set is small, complete, portable. For the man who wishes the highest efficiency, this is the set to build. Price of blueprint and specifications, 50c, or with complete and perfect windings, \$3.00. Photo of set with every order.

Sets built from these plans will receive all broadcasting stations operating under the new laws. Their wavelength range is from 170 to 800 meters.

AUXILIARY TUNER

This new instrument connected to your present receiving set with one wire enables you to easily bring in both the long and short wave stations which you cannot get with your present equipment. It also enables you to eliminate that local interference so you may listen to distant stations.

Copyrighted diagram and complete instructions for building and operating this instrument, 50c, or with all parts, including Condenser, Coils, Switches, and Panel, \$8.50. Complete instrument, \$15. All goods prepaid.

These instruments are easy to build, easy to operate. Everything clearly shown.

S. A. TWITCHELL

1927 Western Avenue Minneapolis, Minn.

VACUUM TUBE HOSPITAL

We Repair and Guarantee Them

Repairing the following tubes and many others

Vacub Amplifiers and Detectors
Moorehead Amplifiers and Detectors
DeForest Amplifiers and Detectors
Cunningham C-299-C-300-C-301-C-301A-C-302

Radiotron U-V-199-200-261-201A-202-WD-11-WD-12.

Reasonable Prices

Mail orders solicited and promptly attended to.

Satisfaction Assured

GEORGE H. PORELL CO., Inc.

Telephone: 7931-R

SOMERVILLE (44) MASS.

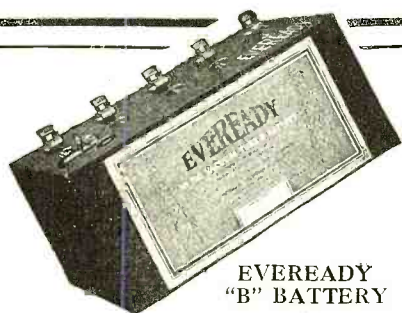
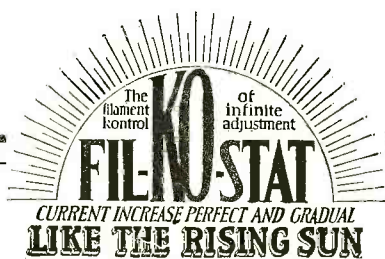

EVEREADY "B" BATTERY

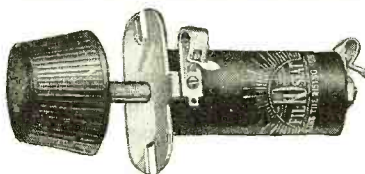

D-X INSTRUMENT CO.

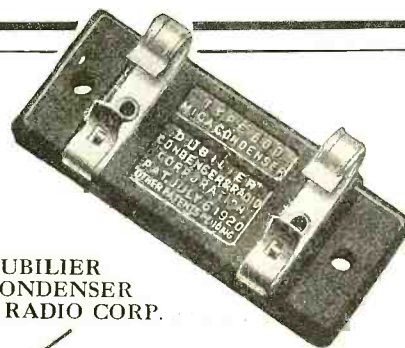

DUBILIER CONDENSER & RADIO CORP.

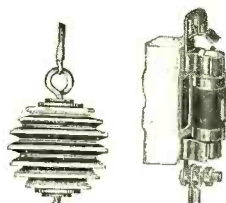

L. S. BRACH MFG. CO.



BALDWIN RADIO ELEC. MFG. CO.

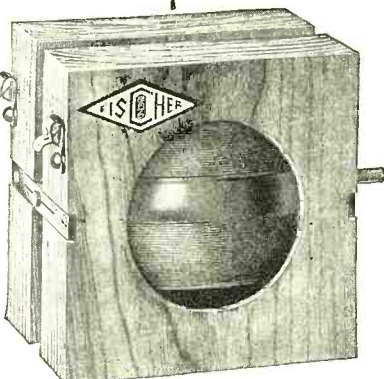
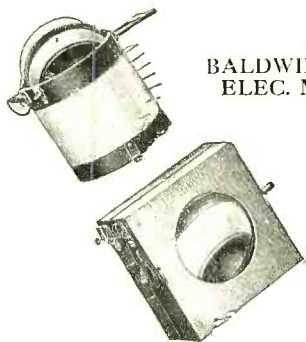

G. H. FISCHER & CO.



NATIONAL CARBON CO.



SHAMROCK MFG. CO.

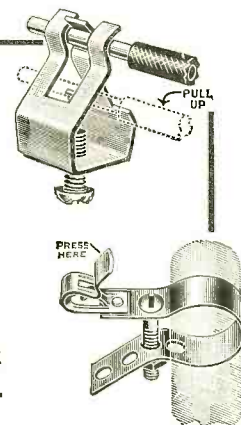
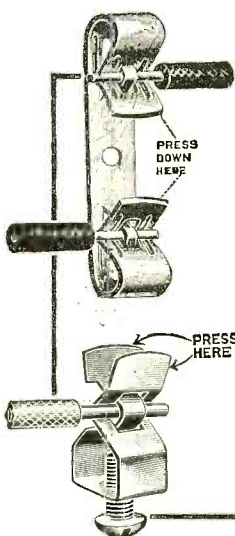

The Above are Representative of Our Many Satisfied Users

{ Fahnestock Spring Binding } Posts and Connectors

Grip Like a Vise—Cannot Jar Loose—Assure Perfect Electrical Contact—Are Easily Attached—and Eliminate Broken and Loose Connections.

FAHNESTOCK ELECTRIC COMPANY

Long Island City

New York

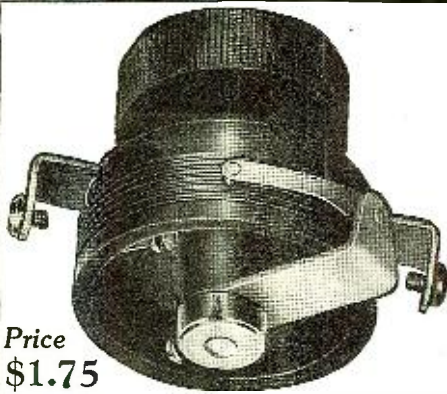

Price
\$1.75

6 ohms, 25 ohms, 40 ohms

The very best in Rheostats

Vernier and Non-Vernier

THE UNITY VERNIER RHEOSTAT

The highest type electrical instrument made for controlling resistance.

A refinement in tuning adjustment, far surpassing the possibilities of any other instrument, is very easily obtained.

The Unity Vernier Rheostat is the only Rheostat with a cut-out switch operating with no change in tuning adjustment.

Interchangeable Resistance Cartridge **2**

—“Hear a set that uses one”—

THE UNITY NON-VERNIER RHEOSTAT

or the Cartridge Rheostat

Where a non-vernier rheostat is sufficient, the Unity Cartridge Rheostat is the best Rheostat made.

The sliding contact is a phosphor bronze fork—surpassing all other types for positive connection and smooth variation.

In addition, it is made in all resistances, and resistances are interchangeable without removing the bracket from the panel.

Unity Potentiometer Cartridges also fit the Unity Brackets

If your dealer cannot supply you, send your check or money-order to the factory with dealer's name.

Unity Manufacturing Company, 228 No. Halsted Street, Chicago
Automatic Screw Machine Products, Stampings, General Manufacturing on Contract or Royalty

DEALERS ARE OFFERED A FREE COUNTER DISPLAY CARD

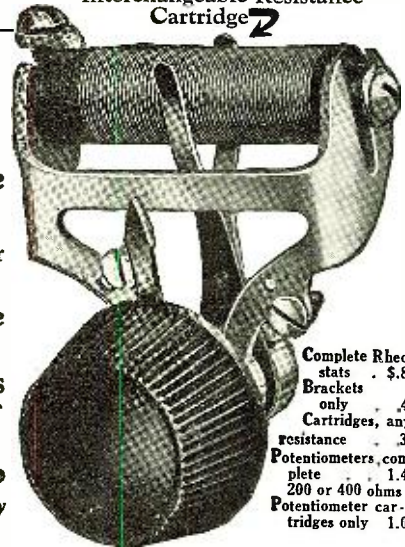

Complete Rheostats . . . \$.80
Brackets
only45
Cartridges, any
resistance35
Potentiometers, complete1.45
200 or 400 ohms
Potentiometer cartridges only1.00

6 ohms, 25 ohms, 40 ohms. Other resistances if desired.

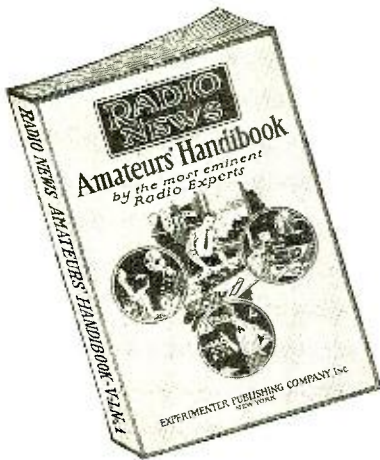

JUST OFF THE PRESS

\$ 1 00
Prepaid

“Radio News”
Amateurs' Handbook

\$ 1 00
Prepaid

Volume No. 1

Chock full of radio constructive and instructive articles from cover to cover. Written by foremost radio authorities, in plain everyday language which everyone can understand. A book which serves as a ready reference and should find a place in the library of every amateur. It contains 224 pages and over 375 illustrations, diagrams, and photographs, bound in a multi-colored heavy board.

Some of the articles included in the Radio News Amateurs' Handbook are:

A Typical Amateur Receiver, A Radio Filter, A Universal Receiver, A Radio Frequency Receiver, A Multi-Range Regenerative Receiver, A Reimartz Set, A 3-Tube Reflex Receiver, A 1-Tube Super-Regenerative Receiver, A Honeycomb Coil Receiver, A Compact Super-Regenerative Set, An Efficient Receiving Set, A Super-Sensitive Receiver, An Armstrong Super-Regenerative Receiver, A well designed Super-Regenerative Receiver, How to Make a Portable Receiver, A Practical Receiver, A Detector-Amplifier Unit, Modern Hook-Ups for the Amateur, Dual Amplification Circuits, A Simple Reflex Circuit, An efficient Amateur Receiving Circuit, A Long Distance Hook-Up, A Receiver Using Rectified A.C. Supply, How to Make D-Shaped Variometers, Regenerative Tuners for R.F. Amplifiers, Head Sets, Reducing Interference With Single Circuit Sets, Broadcast Receiving and Receivers, Hints on Loud Speaker Unit Operation, Amateur Reception on Honeycomb Coils, A Portable Wavemeter, A Wavemeter for Short Wave Lengths, An Aerial Cleaner, The Construction of a Loop Aerial, Wiring the Radio Set, The Construction of a 10-Watt Transmitter, A 5-Watt Telephone and Modulated C.W. Set, A Spark Coil C.W. Set, A Vacuum Tube Transmitter Operating on a 6 Volt Storage Battery, A C.W. Measurement Set, Construction of an Electrolytic Receiver,

A High Frequency Buzzer, Construction of a Modulation Transformer, Two Practical Radiophone Circuits, Loading Coil Design, Meters for C.W. Sets, A Dial Indicator, Regeneration and Super-Regeneration, Radio Frequency Amplification, Damping, Matching Impedances, High Frequency Resistance, Different Types of Coupling, Principles of the Antenna System, The Relation of the Antenna to Detection, Efficiency, Theory of Crystal Detector Operation, Condensers, Monographic Charts for Measuring Capacity, Inductance and Wave-Length, Fundamental Operation of Vacuum Tubes, Operating Characteristics of Vacuum Tubes, Practical Points on Amplifier Operation, Vacuum Tube Facts, Basket-Wound Coils, Winding G-R Solid Wire Coils, An Arc Buzzer Practice Set, A Storage Battery for 1½ Volt Vacuum Tubes, Amplifier Trouble, Notes on Crystal Detectors, Practical Pancake Coils, A Sensitive Detector, Simple Mounting for Variocoupler Secondaries, A Method of Mounting Coils, A Practical Method for Writing Code, Form Wound Coils, Cores for Transformers, An Inexpensive Amplifying Transformer, A Silver Dial, Duo-Vertical Coil Winding, How to Solder Connections, Connecting Phones, How to Wind Duo-Lateral Coils, A Spider-Web Coil Mounting, A Carbon Disc Rheostat, A Device to Eliminate Dial Scratch.

On sale at all leading radio stores. If your dealer cannot supply you, pin a dollar bill to this ad and write your name and address in the margin below this page and book will be forwarded to you postpaid.

EXPERIMENTER PUBLISHING CO., Inc., 53 Park Place, New York



Natural
Re-PRODUCTION

Atlas AMPLITONE LOUD SPEAKER

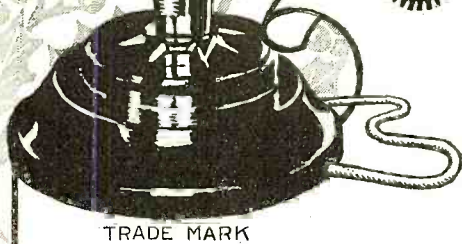

*To the Great Radio Public
Cordial Christmas Greetings*

FOR Christmas give the radio enthusiast his fondest expectation—a perfect radio re-PRODUCER, the *Atlas Loud Speaker*. Natural re-PRODUCTION, identical with the original in the broadcasting studio, is completely achieved. The patented "double diaphragm" responds uniformly to the full range of sound intensities. Adjustable to each individual set and receiving conditions. The *Atlas Loud Speaker* is a gift not only to an individual but to an entire home, an unmistakable sign of your regard and thoughtfulness.

Hear the *Atlas Loud Speaker* at your dealer's. Its amazing naturalness will convince you.

WARNING! Be sure you get the *genuine Atlas Loud Speaker* with our red tag factory guarantee! **\$25**

WRITE FOR BOOKLET: Contains Helpful Information

Sole Canadian Distributors

**THE MARCONI WIRELESS TELEGRAPH COMPANY
OF CANADA, LIMITED**

Montreal, Canada

TRADE MARK

Letters from Users Requested

The remarkable re-PRODUCTIONS of *Atlas Loud Speakers* makes every owner enthusiastic. "Musical experts", writes a man in St. Paul, "have pronounced it the clearest reproduction they have ever heard." What results have you accomplished with your *Atlas Loud Speaker*? Write us about them—TODAY.

MANUFACTURED BY

Multiple Electric Products Co. Inc.

ORANGE ST.

RADIO
DIVISION

NEWARK, N. J.

SOMETHING NEW! IN RADIO

COAST TO COAST
AND
HAVANA, CUBA
WITH A

VOISOMETER

PRICE \$5.50

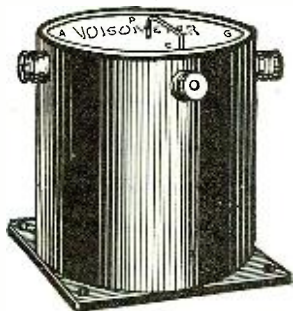

ELIMINATES
THE
VARIOMOTER
VARIOCOUPLER
AND OTHER PARTS

The Voisometer is extremely Simple in Appearance and Operation. You save two or more parts of a tube set a saving of 70 per cent for the Radio Fan.

The only parts used in the Voisometer Sets are as follows.

- VOISOMETER
- VERNIER RHEOSTAT
- GRID LEAK
- TUBE SOCKET
- VERNIER VARIABLE CONDENSER

WITH A COMPLETE WIRING DIAGRAM

CO-OPERATIVE SALES CO.

SOLE DISTRIBUTORS
401 CALUMET BLDG.
ST. LOUIS, MO.

LIVE DISTRIBUTORS & DEALERS WRITE

Let Radio Experts Buy for You

This Service Is Free Why hunt from store to store? Save time, trouble and money—a group of Radio Experts in New York will act as your personal representative, buy for you any standard make of radio equipment you want, from the smallest part to a complete set, either assembled or unassembled, and deliver it to you prepaid—all for less than if you did your own buying. Satisfaction guaranteed. Advice on all radio problems—free to our clients. Write for plan.

PERSONAL SERVICE PURCHASING BUREAU
505 Fifth Ave., Desk 15, New York

MICHIGAN RADIO CORPORATION
GRAND RAPIDS, MICH.

factors the radiation resistance depends upon the antenna height; the greater the height the greater the radiation resistance, so by increasing the height of the transmitting antenna the radiation may increase. From a transmission point of view we arrive at an opposite conclusion from the receiving point of view. This is the reason that all high power stations have extremely high transmitting antennae, and also that they have different receiving and transmitting antennae. Especially where amplification is employed, it will be found that the low antenna will give better results than the high, as far as static reduction is concerned.

ANTENNA CONSTRUCTION

Many amateurs construct their antennae without much consideration or thought as to how the construction affects the antenna constants. It is interesting to note the following, therefore: The fundamental wave-length of the antenna does not vary very much with increase in the number of wires in the antenna. There may be a slight variation, but it is not very great. The fundamental wave-length of an antenna is to a large extent determined by its height. If the height of the antenna is kept constant and the number of horizontal wires are altered it will be found that there is small change in the natural wave-length. The smaller the length the smaller the natural wave-length.

The use of a number of horizontal wires in the antenna instead of one has certain effects on the antenna constants. In the first place it increases the capacity of the antenna.

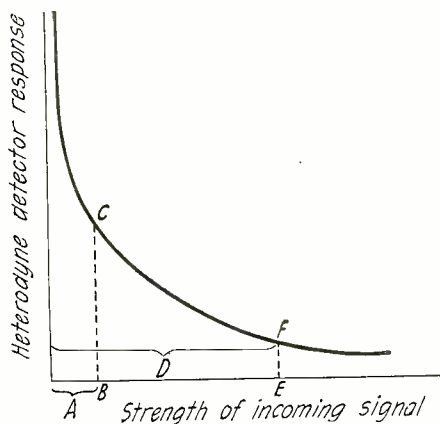

Fig. 2

Curve Showing Heterodyne Response for Strong and Weak Signals.

tenna. The more wires, the greater the capacity. Thus for a given power input into the antenna from a transmitter the maximum antenna voltage will be lower than for an antenna with few wires. The reason for this is that power in the antenna is given by $\frac{1}{2} CV$, hence the larger the C, the smaller the V for a given power. The spacing of the antenna wires likewise influences the capacity. The greater the spacing, the larger the antenna capacity, and the larger the capacity of an antenna the greater will be the antenna current for a given antenna voltage. For transmission purposes where large antenna currents are desired a large capacity antenna should be used, hence a multi-wire antenna is very suitable for transmission purposes. Furthermore, the greater the spacing of the antenna wires the less is the mutual inductance between the wires, therefore, the less the total antenna inductance is. As we increase the spacing between antenna wires the capacity increases, the inductance decreases, and the natural wave-length remains approximately constant, which explains why increasing the number of wires does not materially alter the natural period.

The H. K. Switch



Pat. Pending

The H. K. Multipoint Switch does away with the difficulty of drilling holes in a panel for switch points, only takes a few minutes to mount. Assures good contact. Is neat in appearance. Contacts are arranged so wires can be attached with ease. $2\frac{1}{2}$ in. Dial, calibrated to show contact in use.

PRICE COMPLETE WITH DIAL \$2.00

Awarded Certificate of Merit 38
by Radio News Laboratories.

Do not receive postage stamps.
Be sure to send enough Extra money to cover postage.
Special prices to Dealers and Jobbers.

KNOOP & PENCE CO.
PEOTONE, ILL.



A Twist of the Wrist — IT'S SET

YELLOW TIP MICROMETER ADJUSTING CRYSTAL DETECTOR

Holds not just one but any spot on the crystal. Changed from fixed to adjustable by "A Twist of the Wrist — It's Set". Every adjustment as lasting as in a single adjustment detector. Get the benefit of all the crystal. Micrometer adjustment especially advantageous for reflex and other circuits.

\$2

Write for folder and name of your nearest dealer.

WHOLESALE RADIO EQUIPMENT CO.

Exclusive Factory Representatives

38 WILLIAM ST., NEWARK, N. J.

Dealers and Jobbers write for attractive proposition.

Sent Prepaid In 24 Hours

SEND MONEY ORDER OR REGISTERED CASH

- \$6.50 1 1/2 Volt Guaranteed Det. or Amp. Tubes... \$4.95
- \$5.00 6 Volt Guaranteed Detector Tubes... 2.95
- \$6.50 6 Volt 201A type Amplifier Tubes... 5.25
- \$1.75 Cyclone 22 1/2 V. B Batteries \$1.10; Large... 1.75
- \$4.00 Cyclone 45 V. B Batteries... 2.95
- \$12.00 Genuine Nathaniel Baldwin Phones, complete... 9.95
- \$5.00 2200 Ohm Nereo Phones, complete... 2.95
- \$2.00 23 Plate Var. Condensers \$1.45; 43 plate... 1.85
- \$2.00 Microstat Vernier Rheostat... .85
- \$5.00 9 to 1 Transformers... 2.95
- \$10.00 Guaranteed Tube Set ready for use... 6.95
- DeForest and other tube sets \$9.95, \$14.95 and 19.95
- \$4.50 Variocouplers J. J. N. 1.65
- \$25.00 Loud Speaker \$12.45; others... \$3.95 up
- \$30.00 Music Master Loud Speaker... 25.00

FREE PRICE LIST of many Bargains upon request.

BERGEN RADIO SUPPLY CO.

606 Bergen Ave.

New York City

Increasing the number of antenna wires has one other important result: It decreases to a certain extent the ohmic resistance of the antenna, since there are more wires to carry the current. This means less losses in transmission. As far as reception goes, again, the increase of the number of wires will have very little effect on reception. A single wire does practically everything that a multi-wire receiving antenna does, hence people going in for broadcast reception will do well to stick by the simpler type of antenna, especially since the erection of a multi-wire antenna makes the mechanical construction more difficult and increases the expense to a considerable extent.

HETERODYNE RECEPTION

It is well known that heterodyne reception has the effect of reducing the intensity of static, although the reason for this is not always clear to the amateur. This reduction in static intensity with heterodyne reception is not because the heterodyne eliminates the stray, but because of the character of the response which a heterodyne detector gives to weak and strong signals. Fig. 2 shows roughly the signal response of a heterodyne detector to incoming signals of different intensities. It is seen that for weak signals the response is extremely great, while for strong signals the response is very small. Thus, if a weak telegraph signal of value A, Fig. 2, came in, the response would be very large, E.C. If at the same time a strong static pulse, D, came in, the response of the heterodyne would be very small, E.F. Thus the effect of the heterodyne is to reduce the static signal ratio, by limiting the response of the detector to strong strays and increasing the response to weak signal impulses. This is another reason why low and short antennae are desirable for heterodyne reception. The signal is made weaker, hence the detector response is made stronger.

REDUCING CAPACITY EFFECTS

Capacity effects in a receiver result in very bad howling and frequent noises. No specific rules can be given to remedy this, but it will be found helpful to observe the following: In connecting variable condensers always connect the rotor to the low potential or ground point. Thus in the antenna circuit the antenna series condenser should be connected so that the rotor is connected to ground. In the grid circuit the rotor should be connected to the filament terminal, when that part of the condenser which is nearest the body (in this case the hand with which tuning is done) is connected to the ground which has such a large capacity that the presence of the hand cannot alter its capacity materially. Hence, no potential variations can take place and one cause for howling is eliminated. This applies equally well to variometers. Any instrument which is handled should be connected to the ground or the low potential side where body capacity can have but small effect. By grounding different parts of the circuit this can also be accomplished. Thus the cores of transformers may be grounded, preventing any potential variations here and avoiding audio frequency howling.

Sharp Tuning

By T. T. GREENWOOD

THE desirability of sharp or selective tuning in a radio receiving set becomes more evident as the number of broadcasting stations increase. One of the great drawbacks to sharp tuning is resistance in the oscillatory circuit. Resistance acts to diminish the intensity or strength of the signal by diminishing the amplitude of the wave, since the higher the value of the resistance, the more energy is absorbed in the circuit. Resistance also acts to broaden out the crest of the wave or

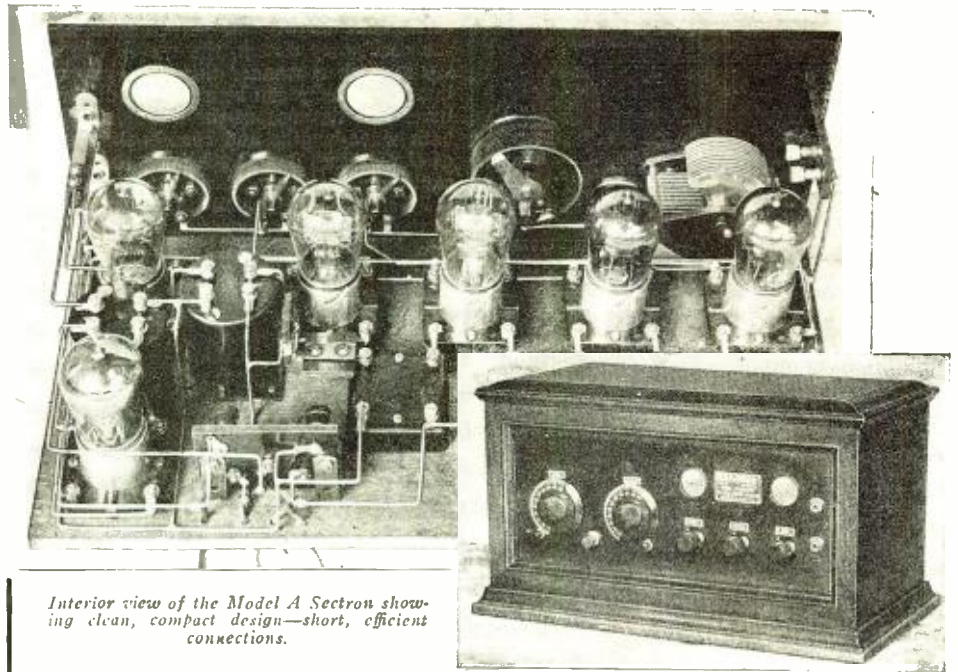

Interior view of the Model A Sectron showing clean, compact design—short, efficient connections.

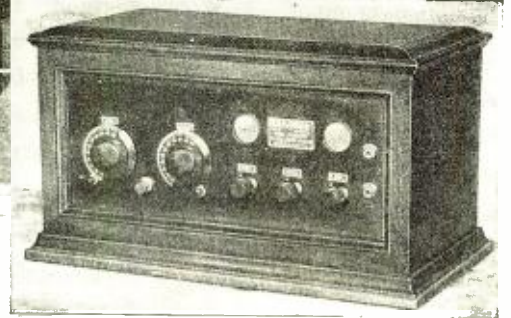

The outside is equally clean-cut and well designed—finished in mahogany, ebony or walnut; will grace any home.

At Last! The Simple, Efficient Radio Set. No aerial required.

Three stages of Radio, Detector, and two stages of Audio—selective, directional—simplicity itself in installation and operation.

SECTRON

SIX TUBES

MANY radio lovers are waiting for radio sets to become simpler to install and operate. No need to wait longer. The Sectron meets all requirements—gets stations 1500 miles or more away—all wave-lengths from 200 to 600 meters.

It is so compact that it may be easily carried anywhere, uses only loop, no outside aerial to put up, battery connections plainly marked—no possible chance to go wrong.

After first adjustment turning of one dial will bring in all stations within range. Works with loud speaker or head phones. Except for A battery and Loop, Sectron is entirely self-contained. The last word in high grade radio workmanship. You cannot know how good a radio can be until you have heard Sectron.

THE SECTRON RADIO COMPANY

Eastern Sales Office
1819 Broadway, New York City

See set at all reliable dealers.
Model B—a compact, leather bound Sectron Portable—complete with batteries, loud speaker and tubes. Model C—a desk set for business men, complete, efficient and moderate in price.



1978 East 55th Street,
Cleveland, Ohio

COUPON

Please send me data and prices on set checked.

- Model A—de Luxe Sectron
- Model B—Portable Sectron
- Model C—Business Man's Sectron

Name

Address

Speed Up Your Production

by sawing bakelite, formica, brass, copper, carbon or wood on a

Boice Junior Bench Saw

A precision machine especially adapted to rapid and accurate work. All metal construction. Top 10" x 13" elevates for roofing. Special guide accommodates panels as wide as 24". Saws 1 1/2" stock. Easily driven by 3/4 or 1 1/2 h.p. motor. Attachments for grinding and sanding. Special saws for bakelite, brass, etc., furnished from stock. Sold on satisfaction guarantee. Thousands in use.

Write today for descriptive circular on this and other BOICE-BUILT Bench Machines and Motors.

W. B. & J. E. BOICE Dept. 812 Toledo, Ohio

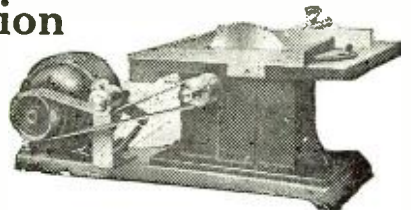

Junior Bench Saw with guides and 6" wood saw. . . . **\$2875**

You can be quickly cured, if you

STAMMER

Send 10 cents for 288-page book on Stammering and Stuttering, "Its Cause and Cure." It tells how I cured myself after stammering 20 yrs. B. N. Bogue, 893 Bogue Bldg., 1147 N. Ill. St., Indianapolis



Wonderful, new device, guides your hand; corrects your writing in few days. Big improvement in three hours. No failures. Complete outline FREE. Write C. J. Ozment, Dept. 32 St. Louis, Mo.

Warren Radio Loop, Cut Away to Show Construction.



Free Your Set from INTERFERENCE

The U. S. Army Signal Corps use loops to obtain absolutely unlimited, uninterrupted radio communication. To really enjoy your super-sensitive set, banish interference from static, stray atmospherics by using a loop aerial, the best you can buy—a Warren Radio Loop. More "persistent" than the dangerous, cumbersome old-fashioned outside aerial. Easier to tune. Built on stronger frame and protected from dust, dampness and meddling by tight cover. Types for all wave meter lengths from 175 to 18,000. Most compact, efficient loop perfected. Buy a Warren Radio Loop Now!

Send for Bulletin T102, containing hook-ups

A Type For Every Set

Type A-737 (300-700 meters) 6 inches square—non-directional	\$10.00
Type A-7236 (175-1000 meters) 6 inches square—non-directional	12.00
Type B-2537 (300-700 meters) 18 inches square—directional	20.00
Type BL-2520 (200-18,000 meters) with honeycomb coil mounting, 18 inches square—directional	25.00

V-DE-CO RADIO MFG. CO.
Dept. N ASBURY PARK, N. J.

make it flatter so that when the two waves of substantially uniform intensity and differing but slightly in wave-length act on the oscillatory circuit, the waves will overlap in such a manner that but little variation in intensity can be noted in rotating the tuner dial throughout the distance enclosing both wave-lengths and consequently neither of the stations can be selected readily to the exclusion of the other.

Figs. 1 and 2 serve to illustrate some of the effects of resistance in the oscillatory circuit.

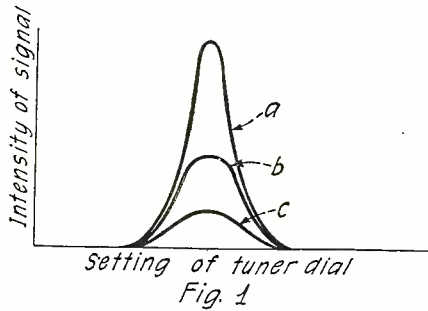

These Curves Show the Effect of the Circuit Resistance Upon the Signal Strength.

Fig. 1 illustrates wave forms *a*, *b*, and *c*, which wave forms may represent the relative intensity of the signal in an oscillatory circuit with various settings of the tuner dial on both sides of the mid or resonant position, and with various values of resistance in the circuit. Curve *a* may represent the character of a wave set up in the oscillatory circuit with but little resistance in it. It will be noted that this wave form has a very pronounced peak, or is sharp, and that it, and consequently the strength of the signal, falls off rapidly for moderate displacements of the tuner dial to one side or the other of the mid or resonant position. Curves *b* and *c* may represent the wave forms in the oscillatory circuit with increased values of resistance therein, the circuit for curve *c* having the greatest resistance. It is to be noted that curves *b* and *c* indicate a reduced intensity of the signals in the oscillatory circuit over that represented by curve *a*. It is also to be noted

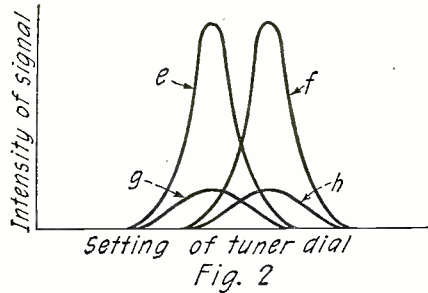

When Two Signals of Slightly Different Wave-lengths are Received Simultaneously, it is Difficult to Tune One Out if the Circuit Has Too Much Resistance, as Shown by Curves *g* and *h*.

that the peaks of the curves are less pronounced, or are flatter, so that the effect of the received signal may be but slightly reduced for moderate displacements of the tuner dial from its mid or resonant position. When two signals of substantially equal strength and differing but slightly in wave-length are superimposed upon the receiving oscillatory circuit, the ability to tune in to either signal may depend entirely upon the sharpness of the tuning and, therefore, upon the low value of the resistance in the oscillatory circuit. When the resistance is low, the peaks of the two waves *e* and *f*, illustrated in Fig. 2, may be clearly distinct and separate and consequently one may readily be tuned in to the exclusion of the other. When, however, the receiving oscillatory circuit has considerable resistance, the wave form received of the signals may be as in-

W. T. 501 Detector Tube **\$2.00** Immediate Delivery

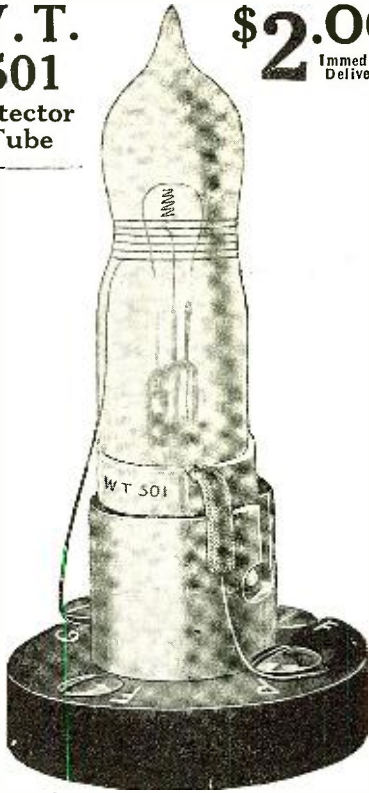

OUR NEW "GOLD LABEL" DETECTOR-AMPLIFIER 1 1/2 V. 25 AMP. STANDARD BASE. \$4.50.

ASK THE MAN WHO OWNS ONE

Operates on dry cells or regular 6 V. A battery. Wiring diagram packed with each tube showing how to use the W. T. 501 with any crystal set or tube set. Special sockets 40c, adaptors 75c, insurance 10c

RADIO RESEARCH GUILD 40 Clinton St. Newark, N. J.

Xmas Buying Is Here Dealers! Profit!

LET US HELP YOU GET THE MOST OUT OF THIS RADIO SEASON

Prompt Shipment
Efficient Service

We carry complete stock of all fast moving nationally advertised Radio Supplies. Orders filled same day received. This means money to you.

SEND TODAY for complete catalog Radio Supplies priced to make you a profit. We list over a thousand items.

We are the largest exclusive radio jobbers in the middle west.

HUDSON-ROSS
123 W. Madison St. Chicago

The Saturn
"Above the Ordinary"
RADIO PRODUCTS

Automatic Plug
Connected, — disconnected in a moment. List Price \$1
Pulling tightens grip on cord tips. Lever instantly releases. Smooth, positive contact. Time and effort economized. Each Saturn Plug unconditionally guaranteed. Extra satisfaction at the same price.

Perfect Jack
Rounded corner brass bracket, nickel plated. Spring German silver blades. Contact points of solid silver. Solder-flux compound on crowfoot offset of blades. Ready for quick connecting.

LIST PRICES

No. 1 Single Circuit, Open	50c.
No. 2 Single Circuit, Closed	55c.
No. 3 Double Circuit, Closed	70c.
No. 4 Single Filament control	75c.
No. 5 Double Filament control	80c.

Write for Folder

The SATURN Mfg. & Sales Co.
48 Beekman St.
New York, N. Y.

Rametra CORPORATION **For Christmas**

Radio Sets and Parts are among the most acceptable Holiday gifts that can be given to anyone as they assure unusually long and economical enjoyment.

Our organization, backed by "Service That is Certain" is well equipped to offer any advice or information you need. Our merchandise—comprising a complete line of quality sets and parts of standard make only—is guaranteed absolutely by both manufacturer and ourselves.

Write or call for detailed information
—Stating what interests you most.

Radio & Mechanical Trading Corp.
23 Warren Street New York City

licated by the curves *g* and *h* and may be of reduced amplitude and with flatter tops. It is to be noted that these wave forms *g* and *h* overlap for the greater part of their height and consequently it may be exceedingly difficult to tune into one wave without getting interference from the other.

In a receiving station, the oscillatory circuit includes the antenna system and the tuning instruments. The main proportion of the resistance in the oscillatory circuit may reside in the antenna system as resistance in the tuning instruments themselves can be reduced by proper design and soldered connections between the instruments. Resistance in the antenna system is usually an indeterminate value and cannot usually be forecast. The ohmic resistance of the antenna wire itself may be kept down by using large or multiple wires and few joints, and these soldered. The resistance in the ground circuit cannot usually be lowered. If the ground circuit is made by attaching the ground wire to a water pipe, the resistance may be unexpectedly high by reason of high resistance pipe connections within the house and by reason of poor contact with the ground outside of the house, even though the water pipe may be connected with an extensive water supply system.

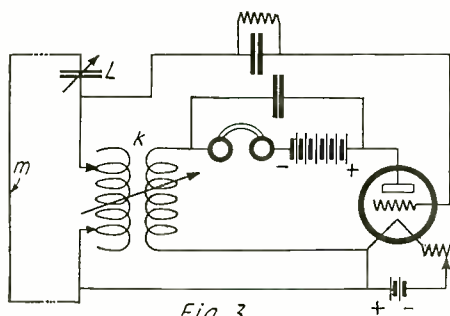

Fig. 3

Circuit Diagram of the Receiver Employed by Mr. Greenwood, with a Loop Aerial.

Possibly the easiest and most convenient manner of keeping down the resistance in the antenna circuit is to employ a loop antenna. This does not necessarily imply the usual form of loop made up of a plurality of convolutions upon a suitable supporting frame but preferably a single convolution or turn extended in a continuous metallic circuit between the antenna and ground binding posts of the receiving set and enclosing as large an area as possible within the limits of the wave-lengths to be received. This type of antenna may consist of a single in-door wire rising from the antenna post to the ceiling and extended along the ceiling throughout the length of the house and thence to the floor and returned along the floor to the ground binding post of the set, thereby making a complete metallic circuit. The horizontal extent of the antenna may be 35' or 40' long and may be 7' or 8' high for satisfactory results. The advantage of such an antenna is that no unknown factors enter into its design. The resistance may be kept down by employing a single continuous conductor without joints in it, and the resistance may be constant for all time.

The writer has used such an antenna in connection with a common type of single circuit regenerative set as shown in Fig. 3, wherein *k* represents the variocoupler and *l*, the variable condenser. The single turn loop antenna *m* is connected as illustrated. This receiving set has been found to be very satisfactory in operation. The tuning is exceedingly sharp and with some stations, notably local station WNAC on its present wave-length, is even distressingly sharp. Stations operating on but slightly differing wave-lengths may be tuned in or out readily

New York Coil Company's Radio Products

Have An Established Reputation for Honest Value, Maximum Results and Ease of Installing

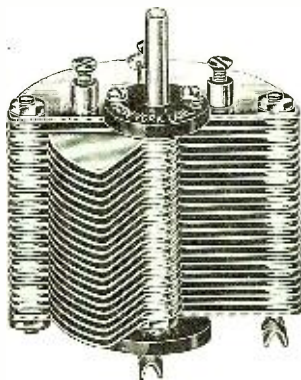

New York Variable Condensers are all equipped with GENUINE BAKELITE INSULATION. Positive contact and of the best value obtainable.

	PRICE
11 Plate	\$1.50
23 Plate	2.00
43 Plate	3.00

Our Perfected Radio Frequency Transformers deliver extraordinary results. A set of two will give the satisfaction you have so long desired. Price\$4.00

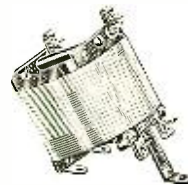

A Variable Grid Leak of quality and precision. Roller contact incomparably better.

Price\$1.50

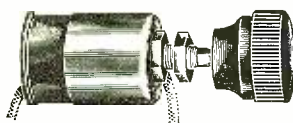

Supplementary Vernier Condenser. Just what you need for sharp tuning.

Price\$1.00



Mica Fixed Condensers of tested and permanent capacity.

\$.35 to \$.75

Couplers, Variometers, Amplifying Distortionless Transformers

NEW YORK COIL COMPANY

338 PEARL ST.

NEW YORK CITY, N. Y.

Pacific Coast: Marshank Sales Co., 1240 S. Main St., Los Angeles, Cal.

RADIO TUBE EXCHANGE

We Repair All Standard Makes of Tubes Including

W. D. 11 or W. D. 12	\$3.50
U. V. 200 or C. 300	\$2.75
U. V. 201 or C. 301	\$3.00
U. V. 201A or C. 301A	\$3.50
U. V. 199 or C. 299	\$3.50
U. V. 202 or C. 302	\$3.50
New 1 1/2 Volt Tubes	\$4.00

All tubes guaranteed to do the work.

RADIO TUBE EXCHANGE
200 BROADWAY NEW YORK CITY, N. Y.
All Mail Orders Given Prompt Attention
Orders sent Parcel Post C. O. D.

WOC--TRESKO

Licensed under Armstrong U. S. Patent No. 1,113,149

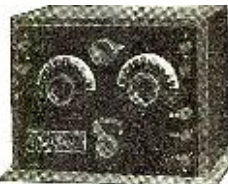

A long distance, 1000 mile, 600 meter range regenerative tuner for

\$12.50

Add parcel post on 6 lbs. New circuit startling results. Cheaper than crystal set. Uses any aerial. Amplifiers

to match set for your loud speakers. Circulars free—Full instructions.

TRESKO

Tri City Radio Elec. Supply Co. DAVENPORT, IOWA
BOX 148

Insure your copy reaching you each month. Subscribe to Radio News—\$2.50 a year. Experimenter Publishing Co., 53 Park Place, N. Y. C.



This magazine is edited by
H. GERNSBACK
 also Editor of
RADIO NEWS
 and
SCIENCE and INVENTION

100 Articles
 Over
 100 Illustrations

FOR SALE AT
 ALL NEWS STANDS

20c. the Copy
 \$2.00 a Year
 Canada and Foreign
 \$2.50 a Year

SEND FOR
FREE
 SAMPLE COPY
 TODAY

See Coupon Below
 for SPECIAL OFFER

"The Electrical Magazine for Everybody"

PRACTICAL ELECTRICS is probably the most novel magazine of its kind ever conceived. It is personally edited by H. Gernsback, editor of SCIENCE & INVENTION and RADIO NEWS. Mr. Gernsback, who founded the old "Modern Electrics" as well as the "Electrical Experimenter," knows thoroughly what his readers want and have wanted for many years. PRACTICAL ELECTRICS, the 100% electrical magazine eclipses the best that was in "Modern Electrics" and "Electrical Experimenter."

Electricity covers such a tremendous field that the man who does not keep abreast with it does himself a great injustice. PRACTICAL ELECTRICS covers that field from every angle. It is written in plain every-day language that all can understand. It portrays the entire electrical development of the month faithfully in non-technical language. It caters to everyone interested in electricity, be he a layman, an experimenter, an electrician or an engineer—each will find in this magazine a department for himself and plenty more.

The December issue now on the news-stands contains 48 pages, over 100 different articles and over 100 illustrations, with an artistic cover in three colors. Professor T. O'Connor Sloane, Ph.D., is associate editor of the magazine.

INTERESTING ARTICLES IN DECEMBER "PRACTICAL ELECTRICS"

- Thermostat System, By Edward Dowis.
- Trick Shuffleboard, a gambler's plant exposed. By Walter B. Gibson
- Electric Baseball Scoreboard, of general interest at the present time. By Samuel Fariss
- High Voltage Transmission, how 220,000 volts are taken care of on a power line. By F. W. Peek, Jr., Consulting Engineer, General Electric Co.
- Voyaging Beyond the Visible. By M. R. McCabe.
- Electric Halloween, also of timely interest at present. By Paul Valliere, Quebec, Army Loud Speaker.

PRIZES

This magazine offers a number of prizes, as follows:

Our \$50.00 Prize Contest for Junior Electricians and Electrical Experimenters includes as its elements simplicity, as great a degree of novelty as possible, and practicability.

Also a new Prize contest giving four prizes amounting to \$37.50 for the best account of an odd electrical experience.

\$5.00 for the best article on Elec-Tricks, the new department.

\$3.00 for the best "short-circuit," the semi-humorous department.

In addition to this, the magazine pays high prices for all electrical experiments, electrical articles, etc. See current issue for full details.

This issue also contains articles by some of the greatest electrical writers, workers and students. The magazine will prove a revelation to any one interested in electricity.

Every issue besides its many other features contains the following departments:

- "New Things Electric"
- "Experimental Electrics"
- "Electrical Digest"
- "Junior Electrician"
- "Elec-Tricks"
- "Motor Electrics"
- "Short Circuits"

"How and Why" (Questions and Answers.)

Make all checks payable to: "Practical Electrics Co."

R. N. 12-23

SPECIAL OFFER

Gentlemen:
 Although your regular price is \$2.00 per year, you will accept my subscription at \$1.75 per year (Canada and foreign \$2.25). I enclose the money herewith and I have written my name and address in margin below.

PRACTICAL ELECTRICS CO., 53 Park Place, New York

without interference. The antenna system and set seem to be fairly good on the reception of distant stations, although probably not remarkable. The set seems to have a consistent working range of about 1,000 miles, and WDAP in Chicago is received at Somerville, Mass., regularly winter and summer.

A further advantage of the single turn loop antenna, outside of the selective tuning it affords, is the fact that it is essentially an indoor proposition and consequently elaborate insulators and lightning arresters are unnecessary.

DEMONSTRATION OF RADIO TO THE FARMERS

The National Radio Chamber of Commerce, assisted by the manufacturers and distributors of radio, has begun a campaign for the purpose of educating the farmers in the practical everyday value of radio on the farm.

The importance of this movement to the radio industry may be judged by these facts:

1. The population of the United States is one-third farmer. But, economically, the farmer is more important than is his voting power. He possesses *one-half the country's buying power.*

2. Because of his daily need of weather, crop and market reports, and because of his need for the recreation and educational means furnished by radio, the farmer is, potentially, *the nation's biggest user of radio.*

3. The National Radio Chamber of Commerce has first hand information in the form of letters and telegrams from hundreds of farmers' organizations in New York, New Jersey, Pennsylvania, Ohio and other states, and from the national organizations, which indicate that the leaders among the farmers are keenly interested in Radio as a practical utility.

4. The National Radio Chamber of Commerce has been assured by these leaders of their co-operation in such a program.

5. The manufacturers and distributors of Radio equipment are entering into the plan and are sending out demonstration parties with receivers and loud speakers, the Chamber securing for them also the privilege of exhibiting their lines and taking orders.

6. The demonstrations have so far been chiefly confined to "County Picnics." Those in New York state occurring in August have an estimated attendance of more than 160,000, more than half of which will be covered by demonstration. Following these picnics, the county fairs furnish the next opportunity to reach the farmers in large number. These are beginning now and extend well into the fall and offer ideal opportunities for educational work of this sort.

The National Radio Chamber of Commerce calls upon all manufacturers and distributors of radio equipment, regardless of affiliation, and all manufacturers' and distributors' organizations to assist in this movement, co-operatively, if possible, independently, if they must.

It is "seed sown upon good ground!"

WIDE USE OF RADIO ON FARMS SHOWN.

The speed with which farmers have taken up radio for practical and social purposes is shown in a recent survey made by the United States Department of Agriculture. County agricultural agents estimate that there are approximately 40,000 radio sets on farms in 780 counties. This is an average of 51 sets per county. Applying the average to 2,850 agricultural counties a total of more than 145,000 sets on farms throughout the country is estimated.

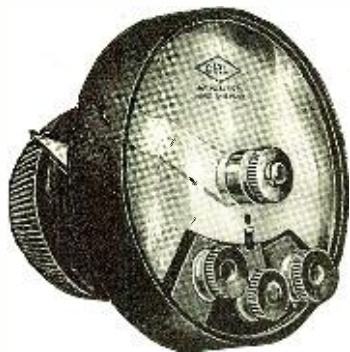

PATENTED
March 13, 1923
Other Patents
Pending



NON-INDUCTIVE

The C R L Potentiometer gives complete plate potential control without the choking effect of wire resistors—no waste of the delicate high frequency radio currents which are so easily dissipated in potentiometer designs having any appreciable inductance.

The Perfect Non-Inductive Potentiometer

The C R L resistor is pure graphite of constant resistance. It is not touched by the sliding contact and hence is free from wear. A brass disc is brought to bear at any one of an infinite number of points to give smooth, gradual, noiseless control. The whole is fully enclosed and a transparent cover protects the working parts from dust and moisture while at the same time it allows a clear view of the interior.

The C R L Potentiometer is the result of months of careful laboratory research and then trials under actual operating conditions. They are truly scientific instruments for real results—carefully tested and fully guaranteed. Furnished in two sizes—400 ohms and 2000 ohms (especially for dry cell "A" batteries to minimize current consumption). Insist on C R L and specify the type desired.



C R L Grid Leak
(Adjustable)

This readily adjustable grid leak will enable you to get quickly the exact potential that provides the maximum signal strength. It has replaced thousands of the uncertain and troublesome grid leaks of the pencil-mark type. The resistor is a fabric strip impregnated with a high resistance compound. It will last a life time.

No. 106 (without condenser)...\$1.50
No. 107 (with grid condenser)... 1.85
(By Parcel Post, 10c. extra)

No. 110 (400 ohms)\$1.75

No. 111 (2000 ohms)\$2.00

By parcel post 10c. extra

CENTRAL RADIO LABORATORIES

305 16th Street

Milwaukee

Wisconsin

Banish Interference! Get Distance!

Kenneth Harkness tells you how to banish interference and get distance in his new book "Radio Frequency Amplification." This book fills an open gap in radio literature. It explains advanced radio in simple understandable English. In 8 chapters of theory Mr. Harkness leads you step by step from the elementary laws of electricity to the advanced principles of modern radio reception. In 7 chapters of practice Mr. Harkness tells you how to build 5 different types of radio frequency amplifying receivers with all details of construction and wiring. The book contains 175 diagrams, drawings and action photographs—176 pages check full of valuable information you need.

EXAMINE THIS BOOK FOR 5 DAYS

We are so confident you will be delighted with this book that we will send it to you for five days' examination and let you judge for yourself! Just fill in and mail this coupon. Send no money. When the postman delivers your book, pay him the full price—only \$1.25 plus postage. Examine the book for 5 days. Read it from beginning to end. See for yourself how it expands your knowledge of radio. Learn all about the remarkable receivers Mr. Harkness describes. If you are not absolutely satisfied, send the book back and we will promptly refund your money. That's fair enough isn't

it? You've nothing to lose and everything to gain, so mail this coupon today and get your copy by return mail. Do it now, while you're thinking about it.

Do it now
SEND NO MONEY
JUST MAIL THIS
COUPON



The Radio Guild, Inc.,
256 West 34th Street,
New York, N. Y.

Send me immediately "Radio Frequency Amplification" by Kenneth Harkness. I will deposit \$1.25 (plus postage) with the postman. If I am not satisfied I may return the book within 5 days for a prompt refund of my money.

Name

Address

**NOTHING IS WORTH WHILE
UNLESS IT IS
"RELIABLE"**

**Your
Ears
Know the
Difference
with this
Condenser**

**Reliable
Neutralizing
Condenser**

For tuned radio frequency and all latest type circuits—the Reliable Micro-air condenser makes your message so much clearer that even the most make-shift radio set is vastly improved.

Clearness — increased tuning range—neutralized capacity reactance of inductive couplings—vernier adjustment for the grid condenser — all available with this highly important member of your set.

Make It "Reliable"

**ONLY
75¢**

**Reliable
AUDIO and RADIO
FREQUENCY AMPLIFYING
TRANSFORMERS**

Surely, you can overcome distortion and secure better amplification with these two Reliable transformers. The "Audio" is made in three favorite ratios. Fully enclosed. Shielded type. Priced at \$4.50 and \$5.00.

The "Radio" types reduce static to a minimum and are made in four types of all necessary ranges. Price \$2.75.

Manufactured by
THE RELIABLE PARTS MFG. CO.
2819 Prospect Ave. Cleveland, Ohio
JOBBERs and DEALERs WRITE

F to S—Main Inductance
A to G—Vernier Rotor
T to P—Untuned Primary
6 to 8—Loading Coil

The B-T Vernier Tuner

in our No. 2 hook-up is giving thousands of users better range, control, selectivity, and dependability than they ever before experienced.

For diversions, they try out others among the good tested circuits for which we supply photo-diagrams.

Our slogan has always been "More than you expect," and in the language of the highest grade firms throughout the radio world, our products "are in a class by themselves."

If you do not know B-T parts you are missing something.

Circulars on Request.

Bremmer-Tully Mfg. Co.
Canal & Harrison Sts. CHICAGO

The county agents' estimates cover every State. In New York it is estimated that in 37 agricultural counties there are 5,502 sets on farms. The county agent for Saratoga County, New York, reported 2,500 sets in the county. In 51 counties in Texas there are 3,085 sets. Forty-three countries in Illinois show 2,814 sets; 26 counties in Missouri, 2,861 sets; 42 counties in Ohio, 2,620 sets; 40 counties in Iowa, 2,463 sets, and 26 counties in Kansas, 2,054 sets. New Jersey, Pennsylvania, Michigan, and Minnesota have between 1,000 and 2,000 sets each.

Federal weather forecasts, crop reports, and market quotations are now broadcast from 150 radio stations throughout the country. Special agricultural news in the form of so-called "Agriograms" and talks on various phases of work of the Department of Agriculture is also sent out regularly from 250 broadcasting stations.

**SIMPLE TESTS FOR GENUINE-
NESS OF UV-199 RADIOTRONS.**

The wide use and great popularity of the UV-199 Radiotron have led to numerous attempts on the part of unscrupulous manufacturers to counterfeit this tube. In external appearance some of the imitations bear such a close resemblance to the genuine tube that it is very difficult to detect the difference. Even the carton markings, the instruction sheets and the trade marks etched on the tube itself have been copied very closely.

However, in spite of the resemblance in appearance, the electrical characteristics of the counterfeit tubes are very different from those of the genuine UV-199. So far, none of the manufacturers of the illegal tube have been able to duplicate the 60 milliamper filament of the UV-199 and most of the counterfeits require as much as one-fourth of an ampere. Since the voltage of this filament can easily be made 3.0 volts or less, the user of such a tube is often misled by the apparently satisfactory operation when the tube is first lighted, but he soon finds that his dry battery is quickly exhausted and often the tube itself fails in a few hours.

Of course, the easiest way of determining the current required by the filament is to use a milliammeter and a voltmeter, but since such instruments are not in common use among radio experimenters another simple method described below may be used which gives a rough approximation of the filament current.

Connect three new six-inch dry cells in series with the tube to be tested and an ordinary 50-watt, 110-120 volt Mazda vacuum lamp. If the filament of the tube being tested does not take more than 60 milliamperes, it will light up almost to normal temperature, but, if the tube is not a genuine UV-199 and the filament requires appreciably more than 60 milliamperes, the resistance of the Mazda lamp will rise, due to the higher current flowing through it, and the voltage on the tube will be so low that its filament will not light. In making the test, be sure that the tube is left in the socket for about 30 seconds to allow the Mazda lamp filament to heat up to constant temperature.

When the proper electrical instruments are available, an even better test is to use a voltmeter and milliammeter.

At three volts the current through the filament of a genuine UV-199 Radiotron lies between 55 and 65 milliamperes.

For this test high quality instruments must be used, otherwise the test is worthless.

A voltmeter having a full scale reading of 5 is recommended. For the milliammeter use an instrument having a full scale reading somewhere between 100 and 250 milliamperes.

**FURNESS
BERMUDA
LINE**
(Bermuda Gov't's Official Contract Steamers)

**Book NOW for Fall and Winter Sailings
to BERMUDA—All-Year-Round
Vacationist's Paradise**

Only 2 Days From New York

Sailings Twice Weekly

Landing passengers directly at Hamilton Dock, avoiding inconvenience of transfer by tender.

Tickets good on either Steamer, insuring unequalled express service safety and via Palatial new Twin-Screw Oil-burning Steamers.

**S. S. "FORT VICTORIA"
S. S. "FORT ST. GEORGE"**

Each 14,000 Tons Displacement

From New York Wed. & Sat. From Bermuda Tues. & Sat.
Modern Hotels—No Passports—All Sports

including Golf (Two 18-Hole Courses), Tennis, Sailing, Bathing, Trap Shooting, Horse Racing, Fishing, Riding, Driving, Cycling, etc.

**ST. GEORGE HOTEL, Bermuda, Finest Cuisine and
Service, Tennis, Golf, Magnificent Tiled Swimming Pool.
WEST INDIES, Delightful Cruises to the Gems of the
Caribbean Sea.**

For Illustrated Booklet on Bermuda, St. George Hotel or West Indies, write

FURNESS BERMUDA LINE
34 Whitehall St., N. Y., or Any Local Tourist Agent

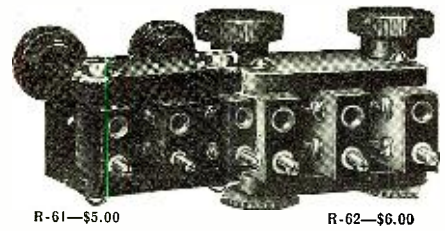

**GET CLOSER TUNING WITH BRANSTON
HONEYCOMB COILS AND NEW MOUNTINGS**

Radio experts will tell you that sets using 3 Honeycomb Coils are best for close tuning. Use Branston Coils and New Branston Bevel-Geared Front Panel or Rear Panel Mountings, with vernier adjustment. Mountings are substantially constructed of genuine Bakelite and are equipped with flexible leads.

**BRANSTON D. L. HONEYCOMB COILS ARE
"STANDARD OF THE WORLD"**

Insist on the genuine. Your dealer can purchase Branston Coils and Mountings, and a complete line of Branston Radio Apparatus from his distributor.

**NEW RADIO MANUAL
SENT FOR 2c**

Compiled by experts and includes five good Honeycomb Coil "Hook-ups" and complete catalog of famous Branston Radio Apparatus. Write today. Give us name of your radio dealer. If he can't supply you, write

CHAS. A. BRANSTON, Inc.
817 Main St., Buffalo, N. Y.
In Canada, Chas. A. Branston, Ltd., Toronto, Ont.

NEW TIRE
GUARANTEE!
**30x3½ 200
CORD**

**WRITTEN GOLD BOND GUARANTEE
WITH EACH TIRE**

Greatest tire sale in America now on! Goodyear, Goodrich, Firestone, Fisk and other fine makes of tires going at record-breaking prices. These almost new tires will easily give thousands of miles of satisfactory service.

GUARANTEED 9 MONTHS

	NEW TIRES		NEW TIRES	
	TIRES	TUBES	TIRES	TUBES
30x3	\$1.90	.90	32x4½	\$3.75 \$1.65
30x3½	2.00	.90	33x4½	3.75 1.65
32x3½	2.50	.90	34x4½	4.00 1.65
31x4	2.75	.90	35x4½	4.25 1.65
32x4	3.00	1.40	36x4½	4.25 1.65
33x4	3.25	1.40	35x5	4.25 1.95
34x4	3.50	1.40	37x5	4.25 1.95

Just send \$1.00 deposit for each tire ordered. Balance U. S. D. subject to inspection. Our written gold bond guarantee with each tire positively assures you nine months satisfactory service or another tire will be given at half price. 6 per cent reduction for cash in full with order. Shipment made same day order is received. Order today—NOW.

INTERNATIONAL TIRE CORP.
218 EAST 14th STREET CHICAGO, ILLINOIS



By Merit Alone, Chiropractic

has grown from an idea in the mind of one man in 1905, to the second largest health profession in the world.

There are now approximately 25,000 practitioners, more than a hundred schools and about 15,000 students.

Twenty-six state governments have recognized the science as distinct and different from anything else on earth.

In less than eighteen years, this growth has been effected, not only without the aid of other professions engaged in getting the sick well, but in spite of their utmost efforts to prevent it.

Chiropractic has never had a single dollar of endowment from state or national governments. It has overcome the prejudice of the public, the opposition of other professions intent on its extermination, and adverse laws in every state in the Union.

It has recruited its patients from among those upon whom other methods failed, and with these failures of other methods upon which to prove its efficiency, it has made the most phenomenal growth of any health profession in the history of the world.

Employ none but a **competent** chiropractor.

DEFINITION
 The practice of Chiropractic consists of the palpation and adjustment, with the hands, of the movable segments of the spinal column to normal position for the purpose of releasing the prisoned impulse.



Write for information regarding Chiropractors or Schools to the

Universal Chiropractors' Association, Davenport, Iowa, U.S.A.

All Rights Reserved



"Make Your Own" with CONSRAD PATTERNS



How to Make a Short Wave Regenerative Receiver
 This set was designed by a foremost radio engineer to fulfil the wants of an all-round broadcast receiver. It covers wave-lengths up to 800 meters. **50c.**

How to Make Detector and Amplifier Units
 This pattern was designed for detector and amplifying units especially adapted for use with our regenerative receiver. It is strongly recommended when the attachment of a loud speaker to that set is desired. **50c.**

How to Make a Cockaday Receiver
 The Cockaday four-circuit tuner is one of the latest advancements in radio. Its main advantage lies in the fact that the set can be adjusted to the highest point of regeneration, and tuning accomplished over a wide band of wave-lengths without the necessity for readjusting the regeneration control. All dimensions, size of wire, number of turns, etc., are given leaving nothing to the imagination. **50c.**

How to Make A Radiophone Crystal Set
 Designed for those without technical knowledge. This set has a range of 30 miles. Packet consists of 4 page illustrated direction pamphlet and full size blue print for drilling and wiring. **50c.**

20 Radiophone Diagrams and Hook-Ups
 These diagrams show how to get the best possible efficiency from the instruments you make or purchase. They cover hook-ups from the simplest to the most complicated, in a way that any amateur can understand and follow without difficulty. Printed on heavy paper, 8 1/2 x 11 1/2 inches, and together with KEY CHART OF SYMBOLS and pamphlet "How to Read Diagrams", are contained in a heavy two-color envelope. **50c.**

How to Make a Reinartz Receiver
 The original Reinartz Receiver is the most popular type of set in existence today due to its simplicity of operation and capability of long-distance reception. Full directions for building this receiver are given in this folder. Two blue prints and instruction pamphlet in two-color manilla envelope. The connections of the set are shown plainly. **50c.**

All About Aerials and their Construction
 These blue prints were made after practical erection of each aerial, and point out how simple it is to erect not only the proper aerial for your particular need, but how to erect this aerial in the most practical manner and at the least expense. Consists of 12 blue prints 8 1/2 x 11 inches and one four-page instruction pamphlet. **50c.**

14 Radio Formulae and Diagrams
 With this packet you need never worry about schematic wiring diagrams, measurements and radio tables. All formulae and radio diagrams are printed on heavy paper. **50c.**

How to Make an Autoplex Receiver
 The long expected one-tube set that will work a loud speaker. Will operate wherever placed and requires but a fringed connection. Every station within its range is amplified sufficiently for a loud speaker. Tuning is very simple, there being but two controls. Any tubes from the "peanuts" up to the "big ones" can be used. This receiver knows no such thing as "critical filament adjustment." The complete plans consist of full sized blue print for wiring and drilling and also a four-page instruction pamphlet giving complete details even as to tuning. **50c.**

How to Make a Neurodyne Receiver
 This pattern gives the complete assembly, wiring, adjusting and tuning of a five-tube Neurodyne receiver. This type of receiving instrument and is noted for its very efficient radio frequency amplification. All the disadvantages of ordinary radio receivers, such as distortion and re-radiation are eliminated. The circuit is also noted for keeping the tubes from oscillating. Put up in packet, with full size blue prints for drilling and wiring and four-page instruction pamphlet. **50c.**

How to Make a Reflex Receiver
 The plans for the reflex receiver were gotten out only after considerable research work by our engineers. Most people have trouble with reflex receivers. It takes an expert to build one that will work satisfactorily. The trouble lies in the values of condensers, etc., in the circuits. If they are incorrect, the set is a dismal failure. The construction details of a reflex receiver, contained in this folder, are the results of their successful efforts. **50c.**

Order Direct From These Dealers—Or If Your Dealer

- | | | | | | |
|--|---|--|---|--|---|
| <p>Abilene, Kans. Union Elec. Co.
 Albany, Ga. Lonsbergs Book House
 Akron, O. Radioart Supply Co.
 Albany, N. Y. Hartens Elec. Co.
 Ignition Service Supply Co.
 Cooper & Hotchkiss
 Kimball Bros.
 Peoples Radio Store
 Standard Elec. Co.
 Wanger Bros.
 Amsterdam, N. Y. Anderson Elec. Co.
 Allentown, Pa. Hess Bros.
 Buchman Book Store
 Altoona, Pa. Altoons Elec. Supply Co.
 Anthony, Kans. LeRoy Hughbanks Rad. Co.
 Astoria, L. I. Astoria Radio Shop
 Atchison, Kans. Low & Blythe Elec. Co.
 Atlanta, Ga. Capital Elec. Co.
 Millers Book Store
 Atlantic City, N. J. Paramount Radio Co.
 Eastern Hdwe. & Sup. Co.
 Sport Shop
 Just Elec. Co.
 Sea Coast Radio Co.
 Auburn, Me. G. L. Foss
 Baltimore, Md. Jos. A. Becker
 Jos. M. Zamolski
 Wilbur Elec. Co.
 Bacharach Radio Co.
 W. W. Hentzschel
 S. B. Berkovich
 Joel Gutman
 Herdas Elec.
 Little Jones Dept. Store
 C. D. Kellert
 J. Meyer
 Murdock Co.
 E. I. Rosenfeld & Co.
 Batavia, N. Y. H. F. Smith
 Bethlehem, Pa. Lehigh Radio Co.</p> | <p>Billings, Mont. Torgerson Bros.
 Birmingham, Ala. Interstate Elec. Co.
 Bluefield, W. Va. Burgess Elec. Co.
 Boston, Mass. Atlantic Radio Co.
 Cutter & Wood Supply Co.
 Seth Fuller Co.
 International Radio Corp.
 Lewis Elec. Supply
 F. D. Pitts Co.
 Brockton, Mass. Eng. Elec. Spec. Co.
 Williams Book Stores
 J. B. Hunter & Co.
 Samuel J. Beckwith
 Chandler & Farguhar Co.
 A. P. Merchant Co.
 Eugene Proctor Co., Inc.
 Radio Sales & Service Co.
 Farrington & Clark
 Berman Radio
 Bridgeport, Conn. Morison Radiophone Parts
 Flynn & Power
 Conn. Radio Supply Co.
 Brooklyn, N. Y. Arthor
 Prooklyn Radio Serv. Co.
 O. Olsen
 Tallner Elec. Co.
 Eklvn. Radio Center
 Bohs Radio Service
 Bklyn. Elec. Lamp & Nor.
 Hore Hall Radio
 Globe Radio & Bat. Shop
 Haag & Vince Co.
 G. Kleinteleh
 C. G. Rosewall
 J. Streiff
 Denmark
 American Phon. Exch.
 Arlington Radio Service
 Barney's Radio Shop
 Bengo Elec. Co.
 J. D. Cunningham
 Duha Elec. Co.
 H. A. Dietz
 Duetmans Music Store
 Kelley & Feist
 Halpern Elec. Co.
 Kensington Radio
 E. C. & H. B. Lagerholm
 G. Moskowitz
 G. Schartz Sons</p> | <p>H. Schur & Son
 Victor Radio Sport Shop
 Walker Elec. Co.
 Breuer Bros.
 20th Century Radio Co.
 Morch Radio
 M. Ullrich
 B. Haupt
 David M. Isaac
 Starr Radio
 Buffalo, N. Y. McCarthy Bros. & Ford
 Robertson Cataract
 O. Ulbrich Co.
 Burlington, N. J. Burlington Elec. Co.
 Butte, Montana Montana Elec. Co.
 Cambridge, Mass. Clapp-Eastham Co.
 University Book Store
 Canton, Ill. Frank White & Bros.
 Camden, N. J. Neisner Bros.
 Carrollton, Mo. Carrollton Radio Shop
 Centerville, Ia. H. E. Luther
 Charleston, Ill. H. C. Swanell & Son
 Charleston, W. Va. John R. Koch
 Charlestown, S. Car. S. C. Radio Shop
 Charlotte, N. C. Smith Novotny Elec. Co.
 Carolina Radio Co.
 Chester, Pa. Neisner Bros.
 Chicago, Ill. Harry Aiter & Co.
 Barawik Co.
 Beckley-Radson Co.
 Chicago Radio App. Co.
 Elec. Appliance Co.
 Inland Elec. Co.
 Marshall-Field & Co.
 A. C. McClurg & Co.
 Montgomery Ward & Co.
 Newark Elec. Co.
 Henry Paulson & Co.
 Sears-Roebuck & Co.
 Chicago Cut Rate Book</p> | <p>Community Book Store
 Izenstark Radio Co.
 Pollett Book Co.
 McArthur Elec. Co.
 P. O. News Co.
 Max Stein
 E. J. Stringos
 Fireside Radio Co.
 Cincinnati, O. Midwest Radio Co.
 Minor Elec. Co.
 Reuter Elec. Co.
 Cleveland, O. Radio Electric Shop
 Radio Eng. & Sales Co.
 H. Lesser & Co.
 Oliver C. Schroeder
 Radio Sales & Rep. Co.
 Columbus, O. Hall Elec. Co.
 Coraopolis, Pa. T. C. O'Donovan
 Cumberland, Md. J. A. Fulton & Co.
 Dallas, Texas Huey & Phillip Hdwe. Co.
 Southwest Radio Sup. Co.
 Radio Equip. Co.
 Denton, Tex. Evers Hdwe. Co.
 Denver, Colo. Electrical Auto App. Co.
 Pratt Book Store
 Reynolds Radio Co.
 Des Moines, Ia. H. W. King
 Iowa Radio Co.
 Detroit, Mich. Federal Elec. Supply Co.
 Twentieth Century Radio Co.
 Crowley Mithr Co.
 McCaulay Bros.
 Detroit Elec. Co.
 Wolverine Radio Co.
 Northwestern Radio Co.
 Duluth, Minn. Kelley Duluth Co.
 Easton, Pa. F. & W. Grand Stores
 E. Orange, N. J. Essex Radio Shop
 United Radio & Sport Shop
 Elizabeth, N. J. H. Richmond & Son
 Elizabeth Elec. Sup. Co.</p> | <p>Eureka, Ill. Klaus Radio Co.
 Fergus Falls, Minn. Grande & Sether
 Far Rockaway, L. I. Dunlap Spgt. Goods Co.
 Scientific Radio Co., Inc.
 Flushing, N. Y. The Electric Shop
 Ft. Worth, Tex. H. C. Meacham Co.
 Galveston, Tex. Galveston Wireless Sup. Co.
 Gardner, Mass. Gardiner Hdwe. Co.
 Gloucester, N. J. Lenny's Variety Store
 Granite City, Ill. Rosenberg Dept. Store
 Great Bend, Kans. Great Bend Radio Co.
 Greensburg, Pa. H. Hamilton
 Hamilton, O. Radio Co.
 Hartford, Conn. Elec. Sup. & Equip. Co.
 F. & W. Grand Stores
 G. Foss & Co.
 Havana, Cuba Diamond News Co.
 Lihberia de Jose Aibelo
 Helena, Mont. Van Blaricom Co.
 Hoboken, N. J. International Book Store
 Eagan's Radio Co.
 Holyoke, Mass. Haskell Elec. Co.
 Independence, Mo. The Melodian Co.
 Hackensack, N. J. Wortz & Puch
 Jacksonville, Fla. Southern Elec. Co.
 Holt Elec. Co.
 Jamestown, N. Y. Willis Switch & Inst. Co.
 Jamaica Plain, Mass. Conrad Radio Co.
 Jamaica, L. I. Scientific Radio Co., Inc.
 Merrick Elec. Co.
 Jersey City, N. J. Arrow Elec. Co.</p> | <p>M. Schlein
 Guarantee Elec. Co.
 Johnson City, Tenn. Bishop Elec. Co.
 Johnstown, Pa. W. T. Grant Co.
 Joliet, Ill. Joliet Book & Sta. Co.
 Kansas City, Mo. Yulenzers Supply Co.
 Donaldson Radio Co.
 Lancaster, Pa. Radio Outfit. & Sup. Co.
 Lawrence, Mass. Schwarzenberg, W.
 Los Angeles, Cal. Leo J. Meyberg
 S. California Elec. Co.
 West Radio Elec. Co.
 Radio Concert & Equip.
 Natick Book Store
 Prode Elec. Co.
 Lewiston, Montana Chas. Williams
 Lock Haven, Pa. Burkett Bros.
 Louisville, Ky. Sutcliffe Co.
 Lowell, Mass. G. A. Hill Co.
 Lyons, Kans. R. I. Case
 Macon, Ga. J. W. Burke Co.
 Memphis, Tenn. Street Elec. Co.
 McKeesport, Pa. F. C. Wampler & Son
 Milwaukee, Wis. Julius Andrae & Co.
 Devey Sport Goods Co.
 Badger Radio Co.
 Minneapolis, Minn. Jacob Andressen Co.
 Findley Elec. Sup. Co.
 Nasrell Hdwe. Co.
 Reinhard Bros. Co., Inc.
 Sterling Elec. Co.
 Peerslee Elec. Co.
 Missoula, Mont. Mission Elec. Sup. Co.
 Montgomery, Ala. Alabama Radio Mfg. Co.
 B. P. Reeves</p> |
|--|---|--|---|--|---|



233 Fulton Street
 Publishers of Consolidated Patterns
 Formerly The Consolidated

Solve Your Radio Problems with E. I. Co. Books

How to Make Radio-Phone Receiving Sets

A non-technical book for the beginner. Gives complete constructional data on the building of a complete Crystal Detector Set, Tuning Coil, Loose Coupler and a Single Audion Tube Set with Amplifying Units. It furnishes all dimensions and working drawings of every part that must be constructed by the amateur. 48 pages, 26 illustrations. Bound in beautiful two-color cover. Size, 5½x7½ in. Prepaid..... **25c.**

Loud Talkers

How to Build Them

Gives complete data for building two distinct types of loud talkers. One chapter deals with improvised loud talkers, and gives complete instructions on how to build suitable horns for use in loud speakers of the Baldwin and other types. With this book anyone can build a successful loud talker, equivalent to the commercial types, costing \$10.00 or more. 48 pages, profusely illustrated, prepaid..... **25c.**

Radio Questions Answered

This book is proving as welcome to the radio public as our "100 Radio Hook-ups", which is now the fastest selling radio publication on the market. "Radio Questions Answered" was gotten up after a thorough canvass of dealers to find out which topics troubled most of the amateurs. Almost 100 questions are answered very fully and in language so simple that even the most inexperienced layman can easily understand. Put up in the style which has made the E. I. books famous all over the world. 52 pages, 2 color cover, 25 Illustrations..... **25c.**

How to Tune Your Radio Set

Covers in comprehensive form, the fundamental principles of tuning. The characteristics of radio waves are fully described and illustrated. Several chapters are devoted to the use and functions of all radio apparatus. The book describes how to tune such sets as the Reinartz, Flewelling, Neutrodyne, radio frequency amplifier receivers and others. 52 pages, 25 illustrations. Prepaid..... **25c.**

100 Radio Hook-Ups

Contains a varied selection of hook-ups from the simple crystal to the more elaborate circuits, with a circuit for every requirement. Crystal hook-ups, combined crystal with radio and audio frequency amplifiers, non-regenerative, and regenerative vacuum tube circuits with and without radio and audio amplifiers. Amplifier units, with straight jacks, filament and switching arrangements, power amplifiers, choke coil, resistance coupled and transformer coupled radio frequency amplifiers. Includes all the latest types of Reflex, super-regenerative, super-Heterodyne, Neutrodyne, Reinartz, Flewelling, 25c. and Bishop. 52 pages, two-color cover

Radio Frequency Amplifiers

Shows the construction of the Radio Frequency Amplifying Transformer and gives complete constructional data. It shows the application of Radio Frequency to amplifying units that the amateur may already possess and gives 15 hook-ups showing practically every use Radio Frequency Amplifying Transformers can be put to. 32 pages, 15 illustrations. Bound in beautiful two-color cover. Size, 5½x7½ in. Prepaid.. **25c.**

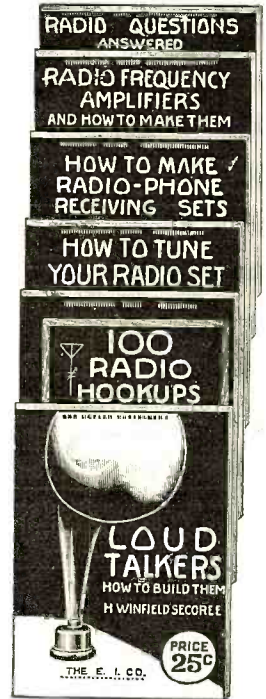

Learn All You Can About RADIO

Take this short reading course

All the technical details and a thorough explanation of radio reception, written in easily understood, non-technical language by a foremost radio engineer and inventor. The five Lecture Books with over 100 graphic drawings give you the knowledge to intelligently buy, design, build, operate and maintain radio receiving apparatus. Tells you how to locate and correct troubles, how to make your apparatus more efficient and gives you a thorough knowledge of radio science. This set of five handsome Lecture Books are a complete radio library. To own them is like having a trained engineer or instructor at your side, answering questions, pointing the way. No matter what your

interest in radio, take advantage of this attractive special offer and be the owner of this fine set of books.

SEND NO MONEY

By special arrangement you can own this \$10 Course comprised in the set of five books for only \$1.97—if you act at once. Simply send us your name and address. Upon receipt pay the postman only \$1.97 plus postage and the books are yours. The supply is limited so order at once.

Cannot Supply You Send Us his Name and Address

- | | | | | | |
|--|--|--|---|---|---|
| <p>Mt. Vernon, N. Y. Stephens Shop
Nashville, Tenn. Zibart Bros.
Newark, N. J. Kamberger & Co. Bassett Radio Sup. Co. Davis Elec. Co. Eddies Wireless Ex. Baumister & Pollard Essex Mfg. Co. W. T. Grant Co. United Elec. Sup. Co. Friedmans Music Shop
New Brunswick, N. J. Schneider Bros. The Elec. Shop
Newburgh, N. Y. Rouss & Davis
New Orleans, La. Interstate Elec. Co.
Nola Radio
Newport, R. I. Geo. H. Chase
New Haven, Conn. W. V. Gaie & Co.
New York City Penno & Co. Frank Radio Co. J. J. Kelleher David Kilchoil & Co. Liberty Radio Co. R. H. Maey & Co. Manhattan Elec. Sup. Overland Radio & Equip Co. Peerless Light Co. Radio Specialty Co. Stanley & Patterson Viking Radio Co. The Winchester Store Army & Navy Dist. Co. Chamberlain Elec. Co. Economy Radio Elec. Service Eng. Co. Goldinger Bros. Gimbel Bros. R. G. Haslinger Herbert & Huesken Allied Radio Co. J. Belmuth J. H. Bunnell & Co. Butler Bros. Carnahan & Dalzell, Inc. Bway Radio Corp.</p> | <p>P. M. Dreyfuss Co., Inc. Delta Elec. Co. Fordham Radio Spec. Co. F. & W. Grand Stores J. L. Lewis & Co. Lowe Motor Sup. Co. Rova Radio Stores Live Wire Elec. Co. Marks Radio Models—S Stores Phillips Sport Shop Welman Bros. A. & A. Elec. Co. Acme Radio Co. Am. Elec. Tech. App. Atlas Elec. Supply Co. Atlas Radio Co. Bersmaler Bros. Franklin Radio Shop J. Gabler Globe Radio Shop Hygrade Elec. Co. International Radio Store J. Kelleher Marlen Hdw. Co. Nassau Radio Co. Times Sq. Auto Sup. Co. Triggers Ace Elec. Co. Baker & Taylor Co. Borough Elec. Co. Coruhia Elec. Co. J. Edelson Keystone Battery Service S. S. Kresge & Co. Langers Radio Store A. Marcus G. H. Masten & Co. Mentz Store Midbro Radio & Elec. Co. Radio & Mech. Trad. Corp. Radio Parlor Radiophons Equip. Co. Riato Elec. Shop St. Marks Radio Co. R. R. Schullstrom F. E. Silverman Woelfer M. Workman Perfection Radio Cortlandt Radio James Gear A. J. Goldman</p> | <p>T. Eaton & Co. Progressive Book Store S. Astor M. & T. Elec. Co. Borough Elec. Co. Marvel Elec. Sup. Co. O. R. R. A. E. Zimmerman Davidson Radio Co. Mogul Elec. Co. Brunswick Supply Co. Stuyvesant Radio Co. Osvars Radio Fordham Sup. Co. M. H. Elec. Co. The Heights Radio Sup. Co. Eclipse Elec. Co. Parkham Radio Co. Crescent Radio Co. Terminal Rad. & Mus. Shop United Anchor Tire Co. Inter City Radio Co. Josephson Redion Corp. Greenwlich Radio Co. H. Goldstein Radio Eajans, Inc. Grand Radio M. Rubin Hannes & Co. Madison Hdw. Store American Radio Co. Electrical Eng. & Con. Co. Niagara Falls, N. Y. H. Messersmith & Sons Norristown, Pa. E. M. Law Warner Bros. E. M. Sargent Co. Omaha, Nebr. Wolfe Elec. Co. Onset, Mass. W. C. Spring Passaic, N. J. J. L. David Simen Bros. Passaic Radio Shop Perth Amboy, N. J. Smerling, J. Amboy Lighting Co. Amboy Radio</p> | <p>Paterson, N. J. Federal Radio & Elec. Co. Pawtucket, R. I. Delancey Felch & Co. Peoria, Ill. Peoria News Stand Philadelphia, Pa. Gimbel Bros. H. C. Roberts El. Sup. Co. Sayre Level Radio Co. Goetz Music Stores F. & W. Grand Stores E. P. Noll & Co. Trilling & Montague Neisner Bros. Schimmel Elec. Co. Radio Sales Co. John Wanamaker Phoenix, Ariz. Nielsen Radio Sup. Co. Poughkeepsie, N. Y. C. P. Raymond Pittsburgh, Pa. Goldsmith & Son Co. Ludwig Hommel & Co. Gain-a-Day Elec. Co. Liberty Incan. Sup. Co. Pitts Radio & App. Co. T. S. Radio Co. of Pa. Doubleday Hill Co. Pittsfield, Mass. W. T. Grant Co. Plainfield, N. J. H. E. Gayle Hdw. Co. Plattsburgh, N. Y. H. E. Atwater Portland, Me. Chisholm Bros. Portland, Ore. E. L. Knight Co. Nelson Elec. Co. Hylands Old Book Store Pottstown, Pa. T. S. Reidelhour & Son Pottstown Radio Sup. Co. Princeton, N. J. Princeton Cycle Shop Providence, R. I. R. H. Supply Co. R. I. Elec. Equip. The Shepard Co. The Outlet Co.</p> | <p>Boston Store Reading, Pa. F. & W. Grand Stores Rochester, N. Y. Hickson Elec. Co. Rochester Elec. Sup. Co. Wheeler Green El. Sup. Co. Eastman Radio Co. R. Schmidt & Co. E. C. Sykes & Co. Neisner Bros. Miller Drug & Elec. Co. Ridgewood, L. I. Ridgewood Radio Shop Rock Island, Ill. H. E. Gelhart & Co. Beardsley Specialty Co. Vail Co. St. Joseph, Mo. Empire Elec. Co. Mannschrecks Book Stores St. Louis, Mo. The Benwood Co. Linze Elec. Supply Co. Foster Book & Cigar Co. St. Paul, Minn. North-West Elec. Eq. Co. Premier Radio Mfg. Co. Pioneer Elec. Co. St. Paul Book & Sta. Co. Crist Book Shop San Francisco, Cal. Richter, Cennad Schenectady, N. Y. Albany St. Radio Store J. Tigar Seattle, Wash. F. B. Wilson Stamford, Conn. Arthura Stillwater, Okla. Stillwater Elec. Shop Syracuse, N. Y. Grant's Alexander Sons Hughes Radio Corp. M. H. Salmon Elec. Co. Toledo, O. Kuebler Radio Co. W. J. Nagel Elec. Co. Aitken Radio Toronto, Ont., Can. H. M. Kipp T. Eaton & Co.</p> | <p>Trenton, N. J. Fleron & Son, Inc. Radio Chain Stores Troy, N. Y. L. H. Cooper & Son Tyler, Tex. R. E. Bryan Union Hill, N. J. N. W. Friedman Uniontown, Pa. Frederick Piano Co. W. F. Utica, N. Y. Dent, Co., M. F. Olds Book Store Utica Elec. App. Co. Utica Elec. Sup. Co., Inc. Waco, Tex. Jackson's Radio Eng. Lab. Washington, D. C. Continental Elec. & Sup. Co. Radio Auto Sup. Co. Watertown, Wis. D. & F. Kusel Co. Watertown, N. Y. F. A. Emmsill & Co. W. Hoboken, N. J. The Heraco Exchange W. New York, N. J. W. N. Y. Heraco Wheeling, W. Va. Gee Electric Co. Wapakoneta, Ohio Heine & Nagel Elec. Co. Waupaca, Wis. Waupaca Radio Sales Co. Wausau, Wis. Janke, Kurth Co. Wilkes-Barre, Pa. Foster Radio & Elec. Co. Wilmington, Del. I. X. L. Radio L. P. Moore Wilmington Elec. Spec. Co. Worcester, Mass. Neisner Bros. Williamsport, Pa. Wilhelm Book Store Yankers, N. Y. Kneifer, T. Westchester Elec. Eq. Co. York, Nebr. Bellacks Youngstown, Ohio Robert F. Phillips</p> |
|--|--|--|---|---|---|

New York City
and Sales Agents for E. I. Co. Books
Radio Call Book Company, Inc.



OPPORTUNITY AD-LETS

Follow these advertisements every month. Reliable advertisers from all over the country offer their most attractive specials in these columns.

Classified advertising rate fifteen cents a word for each insertion. Ten per cent discount for 6 issues, 20 per cent discount for 12 issues. Name and address must be included at the above rate. Cash should accompany all classified advertisements unless placed by an accredited advertising agency. No advertisement for less than 10 words accepted.

Objectionable or misleading advertisements not accepted. Advertisements for the February issue must not reach us later than December 1st.

THE Net Paid CIRCULATION OF RADIO NEWS IS OVER 200,000
EXPERIMENTER PUBLISHING CO., INC., 53 Park Place, New York, N. Y.

Agents Wanted

Agents Wanted in every city and town to sell standard radio apparatus. Attractive discounts given. If interested, write us at once stating age and radio experience. Wilmington Electrical Specialty Co., Inc., 912 Orange St., Wilmington, Delaware.

Rummage Sales make \$50.00 daily. We start you. Representatives wanted everywhere. "Wholesale Distributors", Dept. 73, 609 Division Street, Chicago.

No Dull Times Selling Food—people must EAT. Federal Distributors make \$3,000 yearly and up; Over 100 high grade Toilet Preparations also will increase your profits. A Free Course in Salesmanship and ample Capital furnished. Guaranteed sales. Unsold goods may be returned. Free Samples and advertising matter to customers. Repeat orders sure; Exclusive territory contract. Ask now. Federal Pure Food Co., Dept. T, Chicago.

General Agents—Service Men! Genuine Gold Letters for store windows easily applied. 20 percent cash commission on all orders from local agents appointed by you anywhere. 50 percent discount on your own orders. Free samples. Metallic Letter Co., 422 N. Clark St., Chicago.

Big Money and fast sales. Every owner buys gold initials for his auto. You charge \$1.50; make \$1.50. Ten orders daily easy. Write for particulars and free samples. American Monogram Co., Dept. 153, East Orange, N. J.

We want Salesmen and Agents, either whole or side line, to sell our low priced radio books to the trade. Excellent proposition for live wires. The E. I. Company, Publishers, 233 Fulton Street, New York City.

American Made Toys

Manufacturers on Large Scale, also homeworkers, wanted to manufacture Metal Toys and Novelties. Millions needed of Barking Dogs, Wag Tail Pups, Wild Animals, Automobiles, Indians, Cowboys, Baseball Players, Cannons, Toy Soldiers, Crowing Roosters, Statues of Liberty, Miniature castings of Capitol, Bathing Girl Souvenirs and others. Unlimited possibilities. Guaranteed Casting forms furnished manufacturers at cost price from \$5.00 up, with complete outfit. No experience or tools necessary. Thousands made complete per hour. We buy goods all year and pay high prices for finished goods. Cash on delivery. Contract orders placed with manufacturers. Catalog and information free. Correspondence invited only if you mean business. Metal Cast Products Co., 1696 Boston Road, New York.

Automobiles

Automobile owners, garagemen, mechanics, send for free copy of America's popular motor magazine. Contains helpful, money-saving articles on repairing, overhauling, ignition, carburetors, batteries, etc. Automobile Digest, 528 Butler Bldg., Cincinnati.

Books

Radio Books Latest and Best. Catalog free. Ray Dobbins, 146 West 27th St., Indianapolis, Ind.

"Lights, Colors, Tones and Nature's Finer Forces", including Vibrations, colors; Electromagnetics; Odic-rays; Radio; Colours; Inventions; Meteors; Opportunities. Illustrated; 270 pages, \$2.00. Table contents free. Stevens Publishers, 212 Powell, San Francisco, Calif.

Business Opportunities

Salesmen Make \$120 weekly. Free Radio instrument. Ozarka is longest distance receiver. Introduce it to your friends and secure your own free. No canvassing. 2 sales weekly nets you \$120. Sharpe of Colorado made \$975 one month. Our plan sweeping country. Write today giving name your county. Ozarka, Incorporated, 813 Washington Blvd., Chicago, Ill.

Wanted County Distributors for World Fastest Selling Auto Accessory. Write G. Benross Co., 384 E. 144th St., New York.

Establish your own cash business. Capital \$100 upwards. Dept. X, Paul Kaye, 149 Broadway, N. Y.

Health

Asthma and Hay Fever Cured to stay cured. Write for particulars. C. Butterworth, 374 DeWitt, Belleville, N. J.

Only twenty cents for copy "How to obliterate Tuberculosis within 48 hours." Also latest discovery how old, weak bodies may be made strong and healthy almost overnight. Positive proof submitted. Dr. Hartman, 282 West 70th, New York.

Chemistry

"Popular Chemistry" magazine. "The Experimenter" Monthly. Six Months' Trial—50c. C. Wright Laboratory, Caldwell, N. J.

Learn Chemistry at Home—Dr. T. O'Connor Sloane, noted educator and scientific authority, will teach you. Our home study correspondence course fits you to take a position as chemist. See our full page ad on page 803 of this issue. Chemical Institute of New York, 66 West Broadway, New York City.

Chemical Wonders, Secrets and Mysteries, and Wireless Telegraphy fully explained. Two new Books, 10c each. R. N. Collins Co., 197 Fulton Street, Brooklyn, N. Y.

Correspondence Courses

Dollars Saved—Used correspondence courses of all kinds sold, rented and exchanged. List free. (Courses height.) Lee Mountain, Pisgah, Alabama.

Exchange

200-20,000 Meter Receiver including Radiotron \$35.00. Two Step Amplifier \$22.00. Smith, 4416 Market, Philadelphia, Pa.

1500 mile Vacuum tube receiver \$24.50. Radio, 4416 Market, Philadelphia.

\$110.00 Edison Chrome Nickel Storage A batteries at \$19.85. One hundred and fifty ampere hour capacity. The 30 year life battery at a wonderful price. Guaranteed perfect or money refunded. 375 ampere size at \$42.50 each. Edison type A large size B storage battery plates at 3 3/4c per pair, 4c in lots under 100. Complete B storage battery parts includes, plates, vials, hard rubber separators, special wire and chemical electrolyte with complete instructions for assembling, charging, etc., 45 volt \$5.60, 100 volt \$9.35, 150 volt \$13.90. B. R. Smith, 81 Washington Ave., Danbury, Conn.

For Sale. Westinghouse Aerola Senior Receiving Set including tube \$30.00. George Glover, Clyde, N. Y.

Practically new, nine cylinder hundred horse aeroplane engine. Will trade for good radio receiving set. Rubel, Box 702, Mobile, Alabama.

Edison Elements for Storage B Batteries. Six to ten cents per pair postpaid. (Depending solely on size of order.) I handle strictly first-grade elements only. A. J. Hanks, 107 Highland Ave., Jersey City, N. J.

Exchange. New Amrad 4 tube R.F. Receiver and Baldwin Clariphone for 1 or 5 tube Neutrodyne Receiver. J. M. Ragsdale Jr., Columbus, Mont.

For Sale. Grebe Equipment. Grebe CR-8 \$60.00. ROKK amplifier \$45.00. 1 UV-200 tube \$3.00. 2 UV-201 tubes \$5.00. Magnavox \$23.00. R. Baumgartel, 537 Coit Avenue, Grand Rapids, Michigan.

Help Wanted

We want Salesmen and Agents, either whole or side line, to sell our low priced radio books to the trade. Excellent proposition for live wires. The E. I. Company, Publishers, 233 Fulton Street, New York City.

Earn \$25 Weekly, spare time, writing for newspapers, magazines. Experience unnecessary; details free. Press Syndicate, 5665 St. Louis, Mo.

Detectives Needed Everywhere. Work home or travel. Experience unnecessary. Write, American Detective System, 1968 Broadway, N. Y.

Be a Mirror Expert. \$9-\$10 a day; spare time home at first; no capital; we train, start you making and silvering mirrors. French method. Free prospectus. W. R. Derr, Pres., 26 McKinley St., Baldwin, N. Y.

All men, women, boys, girls, 17 to 60, willing to accept government positions, \$117-\$190, traveling or stationary. Write, Mr. Ozment, 251, St. Louis, Mo., immediately.

Know Yourself, your right occupation, the way to success. Send photo no larger than postcard and 20c for trial analysis. Photo returned. Advisory Bureau, Box 73, Port Chester, N. Y.

Improved Made Toys

Wanted—Manufacturers and Houseworkers to manufacture Metal Toys and Novelties. Wonderful opportunity. Millions needed. In Whistling Birds, Wild Animals, Wag Tail Pups, Crowing Roosters, Automobiles, Baseball Players, Statue of Liberty, Indians, Toy Soldiers, Barking Dogs, and 50 others. No experience or tools necessary. Guaranteed casting forms with complete outfit, at cost. From \$3.50 up. We buy goods all year. Cash on delivery. Higher price for finished goods. Contract orders placed. Send for catalog and information free. The Improved Metal Casting Co., 342 East 145 St., New York.

Instruction

Learn Chemistry at Home—Dr. T. O'Connor Sloane, noted educator and scientific authority, will teach you. Our home study correspondence course fits you to take a position as chemist. See our full page ad on page 803 of this issue. Chemical Institute of New York, 66 West Broadway, New York City.

Languages

World-Remic System, Masterkey to All Languages. Primers, 23 languages, \$1.04 each language: English, French, German, Italian, Portuguese, Spanish. Pronunciation-Tables, 192 languages, 30c each language. Languages Publishing Company, 8 West 40th Street, New York.

Miscellaneous

150 Funny Parodies on Latest Songs 25c. R. N. Collins Co., 197 Fulton Street, Brooklyn, N. Y.

Free—Complete price list of radio parts. Write Aitken Radio Co., 504 Superior St., Toledo, Ohio.

Andres Barreda, Tebaldo Power, Santa Cruz de Tenerife (Canary Islands) Hardware. Merchant would buy 90 d/s automobile and Radio fixtures, batteries, hardware. References offered.

Automobile tire perfected, guaranteed to stand test. Bonus and royalty. Might sell. Investor of merit given prompt attention. J. J. Krudwig, 225 1/2 W. 13th St., Fort Worth, Texas.

Patented Articles, Models, Brass Work, Machine Construction; Dies Made. Baum's Metal Specialties, 1020 Wyandotte St., Kansas City, Mo.

Blue Prints made from your drawings; any size, quantity. Blue Printery, 1410 Atlantic Ave., Atlantic City.

Motorcycles—Bicycles

Don't buy a Bicycle Motor Attachment until you get our catalog and prices. Shaw Mfg. Co., Dept. 6, Galena, Kansas.

News Correspondents

Earn \$25 Weekly Spare Time writing for newspapers, magazines. Experience unnecessary; details free. Press Syndicate, 566 St. Louis, Mo.

Orchard Lands

Big Returns from Pecan, Orange, and Fig Groves. Guaranteed care. Small monthly payments. Dept. B, Suburban Orchards Co., Biloxi, Mississippi.

Patent Attorneys

Inventors: Protect your invention by Experts, skilled in Radio-Electrical, Chemical, and Mechanical fields. New illustrated Booklet, giving much necessary and very useful information which every inventor should know, sent free upon request. Write today to A. M. Wilson, Inc., (Radio 3ARH), 325 Victor Building, Washington, D. C.

Patents. Send drawing or model for examination and report as to patentability. Advice and booklet free. Highest references. Best results. Promptness assured. Watson E. Coleman, Patent Lawyer, 924 F Street, Washington, D. C.

Patents Procured. Send sketch or model today for examination; prompt report and advice. No charge for preliminary advice. Write for free booklet and blank form on which to disclose your idea. Highest references. Promptness assured. Clarence A. O'Brien, Registered Patent Lawyer, 313 Security Bank Bldg. Directly across the street from Patent Office, Washington, D. C.

H. F. Lowenstein, Registered Patent Attorney, Radio Expert. 825 McLachlan Building, Washington, D. C.

Patents—Send for form "Evidence of Conception" to be signed and witnessed. Form, fee schedule, information free. Lancaster & Allwine, 269 Ouray Bldg., Washington, D. C.

Patents—Inventors should write for Free Guide Books and Record of Invention Blank before disclosing invention. Send model or sketch of your invention for our Free opinion of its patentable nature. Radio, Electrical, Chemical, Mechanical and Trade-Mark experts. Victor J. Evans & Co., 922 Ninth, Washington, D. C.

M. P. Laughlin, Patents, Engineer-Attorney, 48 East 41 Street, New York.

Personal

Correspondence Club—Many wealthy members everywhere. Fascinating particulars free. Smith, Box 1167Y, Denver, Colo.

Lonely Hearts—Exchange letters; make interesting new friends in our jolly club. Eva Moore, Box 908, Jacksonville, Florida. Enclose stamp.

Exchange cheery letters with new friends. Write Betty Lee, Inc., 4254 Broadway, New York City. Stamp appreciated.

Exchange interesting letters with new friends. Dolly Gray (Club), Box 186G, Denver, Colo.

Lonesome—Join our club—make acquaintances everywhere. Big illustrated book with descriptions and photos, sent in plain wrapper for ten cents. Bonafide Co., Dept. 58, Kansas City, Mo.

Your Horoscope. Business changes, social, matrimonial prospects. Send birthdate and 10 cents (stamps) for remarkable test reading. Zanya, 202-J West 105th Street, New York.

Postcards and Pictures

French Colonies Free—Beautiful Picture Set, Native Chiefs, Pliers, Pictures, 2c postage. Empire Stamp Company, 346 Lippincott, Toronto, Canada.

Radio Equipment

Genuine Edison Elements (new) for making "B" Batteries, obtained from U. S. Government. A positive and negative element—6c glass tube—3c; all other parts at reasonable prices. Postage, etc. 50c extra per order. Free instructions. Todd Electric Company, 109 West 25rd St., New York.

Radium

Moon-O-Light radium paint shines in darkness; 25c per bottle. Gray & Breky Company, Dept. 45—1448 St. Lawrence Ave., Bronx, N. Y.

Salesmen Wanted

Lightning Strange Battery Compound. Charges discharged batteries instantly. Eliminates old method entirely. Gallon free to agents. Lightning Co., St. Paul, Minn.

Scenery to Rent

Settings for Opera, Plays, Minstrels, Plush Drops. Address Amelia Grain, Philadelphia.

Stammering

St-Stu-t-tering and Stammering cured at home. Instructive booklet free. Walter McDowell, 121 Potomac Bank Bldg., Washington, D. C.

Stamps and Coins

Stamps—50 varieties, Brazil, Peru, Cuba, etc., 10c. 50 different U. S. 25c. 1,000 hinges, 10c. 1,000 mixed, 40c. List free. C. Stegman, 5956 Cote Brillante, St. Louis, Missouri.

Stamps, 105 China, etc., 2c. Album (500 illustrations) 3c. Bullard, Station A7, Boston.

Telegraphy

Learn either code in one hour. Radio Code Chart and Code Cards teach Wireless and Morse Codes, \$1 complete, 2c particulars free. Jean Percival, 2115 York, Des Moines, Iowa.

Learn Telegraphy at Home. Our course is practical, complete. Morse and Radio codes. Endorsed by Railroad and Commercial Telegraph officials. Instrument furnished free. Easy terms. Austin Telegraphy School, Rio Grande St., Austin, Texas.

Learn Morse Telegraphy. Expert telegraphers teach you at home. Individual instruction. Method recommended by railroad and commercial officials who have positions waiting for you. Experienced telegraphers use this automatic instructor to become experts. Booklet RN free. Wireless telegraphy free. Learn-O-Graph Company, Dorota, N. J.

Telegraphy—Both Morse and Wireless taught thoroughly and quickly. Tremendous demand. Big salaries. Wonderful opportunities. Expenses low; chance to earn part. School established fifty years. Catalog free. Dodge's Institute, Cour St., Valparaiso, Ind.

Ventriloquism

Ventriloquism taught almost anyone at home. Small cost. Send 2c stamp today for particulars and Proof. Geo. W. Smith, Room M-808, 125 N. Jefferson Ave., Peoria, Ill.

Wanted to Buy

Full Value Paid for Old Gold Jewelry, Watches, Diamonds, crowns, bridges, dental gold, silver, platinum, gold or silver ore, magico points, old false teeth. Packages returned if our offer is not satisfactory. United States Smelting Works (The Old Reliable), 120 So. State St., Dept. 16, Chicago, Ill.

For Inventors

If you have a practical, useful invention to sell (patented or patent pending), write us today. American Patents Corporation, Barrister Bldg., Washington, D. C.

Wireless

For Christmas Only, UV201A, UV199, WD11, WD12, C299, C301A, (no bootlegs) \$5.45. Dealers wanted. C. H. Anderson, Lewistown, Mont.

Genuine R. C. A. Tubes, 201A, WD11, WD12, UV199, C299, \$5.40. UV200, \$4.25. All tubes fully guaranteed! Prompt shipments; order at once. Capitol Radio Company, Box 322, Jefferson City, Missouri.

Cabinets—Catalog on request. Special cabinets made to order at low cost. Manufacturers' and jobbers' inquiries invited. Panels—plywood; natural, 1/2 sq. in. 7 dull black finish, 1 1/2 sq. in., postpaid. Miami Cabinet Co., Yellow Springs, Ohio.

Protect Your Tubes. coils, batteries, etc., with small fuse wire in series. Six feet assorted, 50c. RCZP, Junction City, Kansas.

Sets Overhauled, repaired, rebuilt, enlarged. Any circuit. "Twelve Years" experience and up-to-date. Radio Repair Shop, Junction City, Kansas.

Magnavox R3 or M1. Latest nationally advertised reproducers. List \$35. Introductory \$25. The R2, Combination Sets, and Power Amplifiers are \$10 off list prices if you send names of three promising Magnavox prospects. The factory sealed carton is your guarantee. Radio Central, Dept. R, Abilene, Kansas.

Radio Agents: Write for attractive quotations on nationally advertised goods. Radio Central, Abilene, Kansas.

Radio Panels. Cut exactly to size and a guaranteed 12 hour shipment. 1/2" thick .01 1/2c per square inch. 3-16" thick .01 1/4c. Made of the highest grade black fibre. This material possesses electrical strength of 200 volts per mil, is inexpensive, unbreakable, easy to work and takes a fine finish. We pay postage. Radio Instrument & Panel Co., 564 W. Monroe St., Chicago, Illinois.

Radio Tubes Repaired. One Day Service, at lowest uncomparable prices. All Guaranteed. Write S. Strobel & Co., 3923 N. 6th St., Philadelphia, Pa.

Reflex Sets—Latest most economical hookup. Coast to coast. Only half the tubes. We specialize in parts and complete assemblies for ERLA one, two and three tube reflex sets. Information on request. Other specialties and standard apparatus. Western Wireless Supply Company, 2162 North California Avenue, Chicago, Illinois.

Panels 8x20—\$1.60, WD12 Tubes \$5.25. American 200—\$3.00. 23 Plate Variocondensers \$1.25. Catalogue Free. Stewart Radio Supply Co., 3124 Cherokee, St. Louis, Mo.

Low Prices on Radio. .0005 Vernier Condenser \$2.98. Audion Set ready to wire \$11.98. Crosley Sets \$20.00 up. Write for literature. Satisfaction or money refunded. Spies Radio, Bank & Ann, Baltimore, Md.

Wanted—Young Men Electrically and Mechanically inclined to start a small Radio "B" battery business of their own. The business is of such nature that it will require capital of \$5.00 to \$50.00, and may be conducted at home or by mail. Complete instructions for twenty-five cents in coin. Co-Operative Merchandise Company, 63 Chestnut Street, Chelsea, Mass.

Build your own electrolytic storage battery charger. Plans and complete instructions, \$1.00. Descriptive circular free. Peerless Electrical Parts Co., 105 Harris, Rochester, N. Y.

Immediate delivery. Tubes, Magnavox, Phones, Battery Chargers, storage and "B" Batteries, Couplers, Variometers, Condensers and all parts with Radio Corporation, DeForest and "Neutrodyne" Receiving Sets. R. B. Electric Co., Distributors, Galva, Ill.

15c lettered binding posts, complete set eight—60c two sets—\$1.00. Prepaid, same day. Stamps accepted. Everything in radio. Ask for quotations. List for stamp. Kladag Radio Laboratories, Kent, Ohio.

Build your sets with quality parts and get sure results. Radio Parts Co., Box 56, Dunellen, N. J.

Boys! Don't Overlook This. The "Rasco" Baby Detector. Greatest detector ever brought out with molded base. Fully adjustable. See former advertisements in this publication, or our catalog. Detector with Galena Crystal, complete 50c, the same detector with Radiocite Crystal, 75c prepaid. Send for yours today. Radio Specialty Company, 96-98 Park Place, New York City.

Attention!—50 Vacuum tube hook-ups. The greatest collection of vacuum tube circuits ever brought under two covers at such insignificant cost. These diagrams will be found in the great "Rasco" catalog, which contains ray materials and parts in a greater profusion than any other catalog. 15c in stamps, or coin, will bring the catalog to you. Radio Specialty Co., 96-98 Park Place, N. Y.

Edison Storage "B" Battery elements. Large size, full capacity. 3c per pair, in lots of 100. Kindly send postage for 5 1/2 lbs. per 100 pair. Gilman's Battery Shop, 57 Washington Ave., Chelsea, Mass.

100 Volt Rechargeable "B" Battery made from Edison Elements \$17.50. Edison Elements 6c pair, tubes 2c, nickel wire 1c, separators 1c. Build yourself 100 Volt rechargeable "B" Battery \$12.50. N. Roberts Rechargeable Storage Battery, 41 Jefferson St., Brooklyn, N. Y.

The How and Why of Radio Apparatus, by H. W. Secor, E.E. This newest book on radio matters fulfills a distinct gap in wireless literature in that, while the treatment is made as understandable and as free from mathematics as possible, it at the same time incorporates a wealth of technique and instruction for the Radio Amateur—the Radio Operator—the Installation and Designing Expert—as well as teachers and students of the subject in general. A glance at the following list of chapters gives but a very scant idea of the extensive and useful radio knowledge provided in its text: The Induction Coil; the Alternating Current Transformer; Radio Transmitting Condensers; The Spark Gaps; Radio Transmitting Inductances; Radio Receiving Tuners; Radio Receiving Condensers; Detectors; Telephone Receivers; Radio Amplifiers; Construction of a Direct Reading Wavemeter and Measurement of Inductances; Appendix containing very useful tables, covering all subjects treated in this very unusual book. This newest of Radio Works, cloth bound in Vellum de Luxe, Gold Stamped and Hand Sewed, has 160 pages. Size of book 6x9 inches. The How and Why of Radio Apparatus. Postpaid, \$1.75. Experimenter Publishing Co., Book Dept., 53 Park Place, New York City.

PATENTS

To the Man with an Idea

I offer a comprehensive, experienced, efficient service for his prompt, legal protection and the development of his proposition. Send sketch, or model and description, for advice as to cost, search through prior United States patents, etc. Preliminary advice gladly furnished without charge. My experience and familiarity with various arts frequently enable me to accurately advise clients as to probable patentability before they go to any expense.

Booklet of valuable information and form for properly disclosing your idea free on request. Write today.

RICHARD B. OWEN
PATENT LAWYER
2 Owen Building, Washington, D. C.
2276A Woolworth Bldg., New York City

3

Brings you a Genuine UNDERWOOD TYPEWRITER

10 DAYS FREE TRIAL Your \$3.00 unconditionally returned if at end of 10 days you are not satisfied with this late model UNDERWOOD typewriter rebuilt by the famous Shipman Ward process.

GREAT PRICE SAVING Direct to you from the largest typewriter factory in the world by our money saving methods.

EASY MONTHLY PAYMENTS So small that you will not notice it while you enjoy the use of this wonderful machine.

FREE BOOK OF FACTS Explaining Shipman Ward's wonderful system of rebuilding typewriters and also valuable information about the typewriter industry both instructive and entertaining.

Act Today!
Mail Coupon



5 Year Guarantee

Shipman Ward Mfg. Company
1939 Shipman Building
Montrose & Ravenswood Aves., Chicago

Name.....
St. and No.....
City..... State.....



UNI-FLEX COUPLER

Cut 2-5 size interchangeable stators and Rotors Type "S" plain. "ST" tapped Coils.

Standard Lattice Coils All Sizes

Tapped Coils 150-T-10 100-T-22

Lattice Coil Specialties



VARIO-METERS

Cut 2-5 size

VARIO-COUPLES

MICRO-MIKE CONDENSERS

DALTON, WHITTIER-TRUE CO.

Dept. R-11
2905 W. MADISON ST. CHICAGO

ARE YOU SELF-CONSCIOUS?

Embarrassed in company, lacking in self-control? Let me tell you how you can overcome these troubles. M. VERITAS, 1400 Broadway, New York City



STEPLESS · NOISELESS

COMPACT · PERMANENT

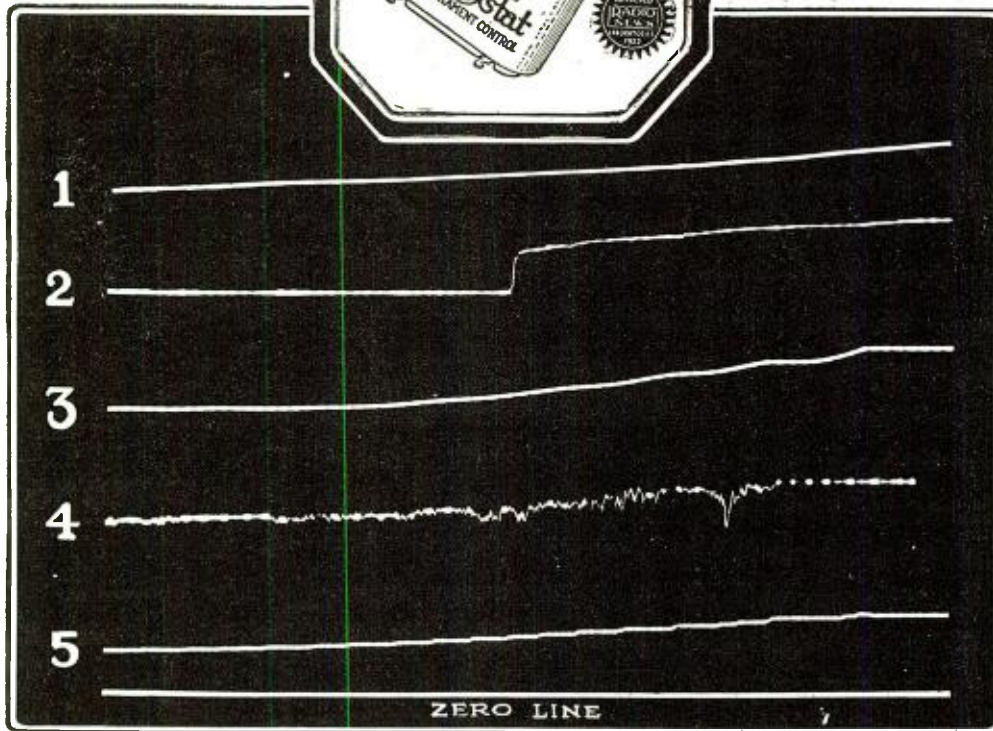

The Graphite Discs in the Universal Bradleystat Surpass All Other Resistors for Perfect Filament Control!

SUBSTITUTES have been offered, from time to time, for the scientifically-treated graphite discs in the Universal Bradleystat. Carbon powder, dust, flakes and other materials have been tried without success.

For a time, such materials appear to give satisfactory service, but they soon pack into a solid mass and the filament control is destroyed.

The Allen-Bradley Co. has built graphite disc rheostats for over twenty years for battle ships, mines, rubber plants, textile mills and other places requiring smooth, stepless control. This wide experience has made possible the Universal Bradleystat, backed by a guarantee of excellence and performance which assures every Bradleystat purchaser of a filament control that is perfect and permanent.

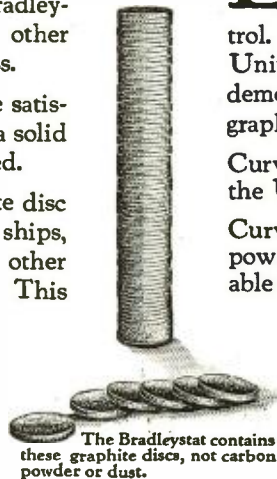

The Bradleystat contains these graphite discs, not carbon powder or dust.

LABORATORY tests are made frequently to compare the performance of the Bradleystat with other types of filament control. A recent oscillograph test made at the University of Wisconsin is shown above to demonstrate conclusively the superiority of graphite discs over other resistance materials.

Curve No. 1 is the smooth perfect control of the Universal Bradleystat.

Curves No. 2 and 3 show the control of carbon powder or dust rheostats. Observe the unreliable and irregular control obtained.

Curves No. 4 and 5 illustrate the control of two types of wire rheostats.

Remember—The Universal Bradleystat can be used with any receiving or amplifying tube, and with 5-watt sending tubes.

Retail Price \$1.85
In Canada \$2.50

Allen-Bradley Co.
Electric Controlling Apparatus
287 Greenfield Ave. Milwaukee, Wis.

All Reliable Dealers
Sell the Bradleystat

THE ALLEN-BRADLEY CO. HAS BUILT GRAPHITE DISC RHEOSTATS FOR OVER 20 YEARS

A Brand New Grid Leak

WITH

Stepless Adjustment from $\frac{1}{4}$ to 10 Megohms

CROSLEY
MANUFACTURING CO.
RADIO DIVISION
CINCINNATI OHIO

September 8, 1923.

ALLEN-BRADLEY CO.
Milwaukee, Wis.

Gentlemen:—

I just received our laboratory report wherein the Bradleyleak is complimented very highly when compared with other adjustable leaks. The Bradleyleak gave smooth, uniform control without sudden alterations of the grid circuit, and is the only device tested in our laboratory which is stable in operation. We found it quite independent of atmospheric conditions, a factor not found in other adjustable leaks exceeding one megohm.

I cannot impress you too strongly with the great necessity of an adjustable grid leak for radio receiving sets and feel confident that the Bradleyleak will find a very popular field as soon as its operation is appreciated.

Yours truly,

CROSLEY MANUFACTURING CO.

Ray Lewis



*Crosley Laboratory Enthusiastic
over this remarkable grid leak*

THE Bradleyleak is now ready for you!

After months of laboratory research, a new and better adjustable grid leak has been developed which provides a stepless range of resistance from $\frac{1}{4}$ to 10 megohms. This problem has defied radio engineers for a long time, but finally has been solved through the use of two columns of discs of special composition placed under the variable pressure of the Bradleyleak knob. Any conceivable resistance is obtained with utmost accuracy by turning the adjusting knob. When once adjusted, the setting is permanent. [Read the letter from the Crosley Manufacturing Company's Laboratory.]

The radio world has been waiting for a real adjustable grid leak. Here it is! There is no substitute for the Bradleyleak, either in performance or accuracy. It is furnished with a grid condenser, if you desire. Your dealer will get the Bradleyleak for you. Avoid unreliable makeshifts, and improve your tube efficiency by installing the Bradleyleak.

BE UP-TO-DATE! MAIL THE COUPON

Retail Price

\$1.85

P. P. 10c

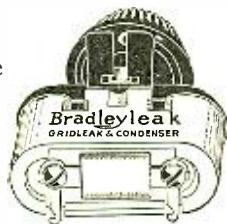

Condenser

.00025 mf.

35c extra

*Unaffected by atmospheric conditions.
Smooth and uniform in adjustment.*

Bradleyleak

THE PERFECT GRID LEAK

Allen-Bradley Co.
287 Greenfield Ave., Milwaukee, Wis.

I am glad to hear that a dependable, adjustable grid leak can now be obtained. Please send me your descriptive folder.

Name _____

Address _____

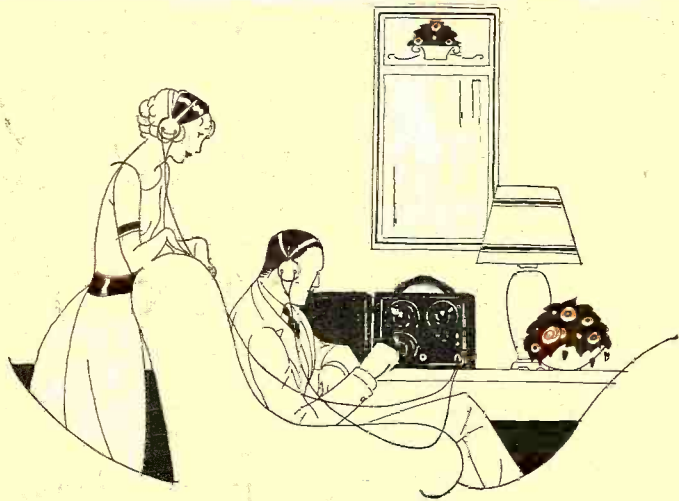

Radiotron UV-199

A Small Tube That's a Big Performer

Radiotron
UV-199

For detection or
amplification

\$6.50

The new UV-199 is proving a mighty popular member of the Radiotron family, particularly for portable sets.

Only three-and-a-half inches high. And drawing so small an amperage that it will work on flashlight batteries. It has been called the "tube with nine lives." Battery economy, long life and sensitivity are the big points of Radiotron UV-199. And if by accident it should be operated at too high a temperature, instead of burning out like the other tubes, it becomes inoperative and can be brought back to normal operation all over again by disconnecting the "B" battery and lighting the filament for twenty minutes.

For quiet operation—great ruggedness—uniform operation Radiotron UV-199 is unsurpassed. Each new Radiotron has marked a big step in radio advancement. The RCA mark is the foundation of radio growth—and your protection when you buy. Ask for Radiotrons—and look for the mark.



This symbol
of quality
is your pro-
tection

Radio Corporation of America

Sales Offices, Department 2065
233 Broadway, New York

10 South LaSalle Street, Chicago, Ill.

433 California Street, San Francisco, Cal.

Radiotrons